

Introduction to Physics – Group Sheet
Physics 103 – General Physics

Your group member names:

1) Discussion Overview – Your TA will give you some basic information about how discussion section will work this semester.

2) Find the people in your group. Record the names of all your group members at the top of this sheet.

3) Once you're in your small group, determine one thing that all of you have in common (NOT including: "you're all students," "you're all taking physics," "you're all in Madison/Wisconsin/on Earth," or "you're all human beings").



Introduction to Physis
Physics 103 – General Physics

Reflect on the experience you've had so far with today's topic. What sorts of notes might you want to write on a note sheet for the exam (which you can test out by using for the rest of the worksheet and on this week's homework and quiz too)? Keep these notes to help assemble your full note sheet in a few weeks.

4) From time to time, you may be given values in one unit, but the equation that you need to use requires another unit. In those cases, you'll need to convert from one unit to another. Use the following relationships to fill out the boxes below:

$$1 \text{ mile} = 5280 \text{ feet} = 1609.3 \text{ meters} = 0.2897 \text{ leagues}$$

$$8 \text{ miles} = \boxed{} \text{ feet}$$

$$50 \text{ mph} = \boxed{} \text{ feet/hour}$$

$$5400 \text{ meters/hour} = \boxed{} \text{ meters/second (m/s)}$$

$$68 \text{ leagues/day} = \boxed{} \text{ m/s}$$

$$1 \text{ square mile} = \boxed{} \text{ square feet}$$

$$1 \text{ square meter} = \boxed{} \text{ square feet}$$

Discussion 1 Exercises
 Physics 103 – General Physics

5) One area of math that you'll be using a lot is trigonometry. Thankfully, as some of you may already know, there's a helpful mnemonic to aid you with all those pesky trig functions. It goes like this:

SOHCAHTOA*

This is short for **Sine is Opposite over Hypotenuse**, **Cosine is Adjacent over Hypotenuse**, **Tangent is Opposite over Adjacent**. Given a right triangle, it allows you to find the sine, cosine, and tangent of any angle without too much trouble.*

A) Consider a triangle with sides of lengths 5, 4, and 3. Find the sine, cosine, and tangent of θ without your calculator. Then determine the angle (for which you'll need your calculator).

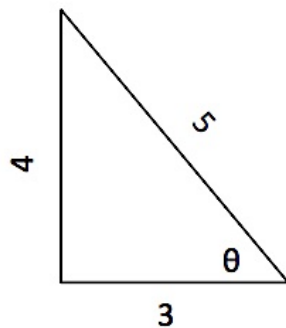

$\sin\theta =$
 $\cos\theta =$ $\theta =$
 $\tan\theta =$

B) If the angle Φ (phi) in the triangle shown is equal to 30° determine the lengths of the two missing sides of the triangle. In this case, you'll need to use your calculator to find the trig functions.

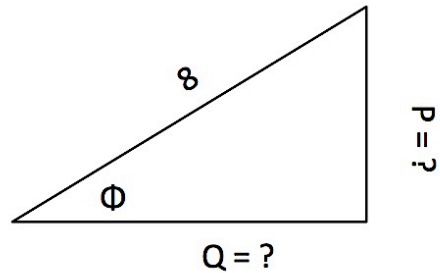

$P =$ $Q =$

Discussion 1 Exercises
 Physics 103 – General Physics

6) Let's go on a treasure hunt. The map we are going to follow is on the next page. We'll start at the large dot labeled "START." To the right of the map are a series of directions given as vectors. If we add these vectors beginning at our starting place, we should arrive at the right spot.

The first vector has been placed on the map for you.

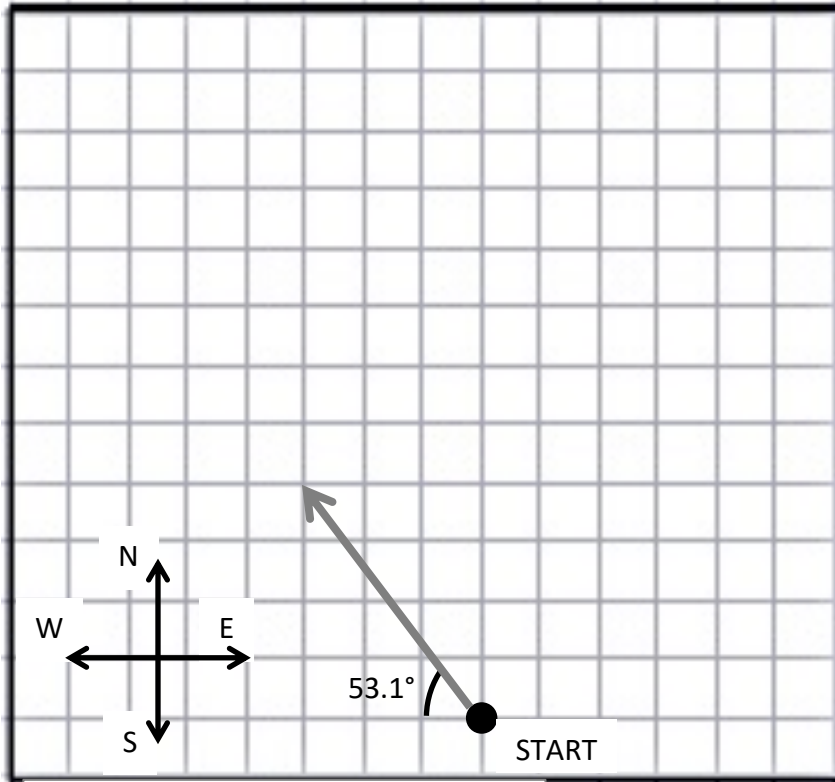

$$A_{\text{east-west}} = \text{adjacent} = 5\cos(53.1^\circ) = 3$$

$$A_{\text{north-south}} = \text{opposite} = 5\sin(53.1^\circ) = 4$$

Vector A: 5 paces
 53.1° North of West

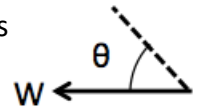

Vector B: 3 paces
 North

Vector C: 4.2 paces
 45° South of East

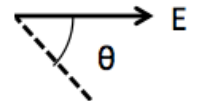

Vector D: 5.4 paces
 21.8° East of North

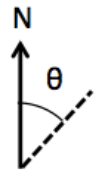

Vector E: 8.1 paces
 7.1° North of West

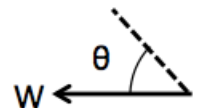

- A) Place an X at the point you end up at after following all the directions.
- B) What is the net distance between your starting point and your ending point?

Discussion 1 Exercises
Physics 103 – General Physics

C) If you draw a vector from your starting point and ending point, this is the vector that results from adding vectors A, B, C, D, and E. Give the magnitude and direction of this vector from North.

7) Fill in the following boxes with the missing vectors. For the first two, also indicate the magnitude of the missing vectors.

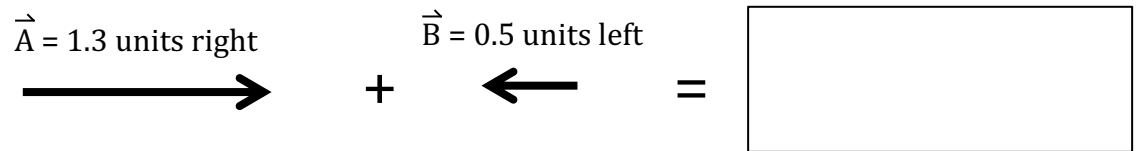
$$\vec{A} = 1.3 \text{ units right} \quad + \quad \vec{B} = 0.5 \text{ units left} \quad = \quad \boxed{\phantom{\vec{C}}}$$

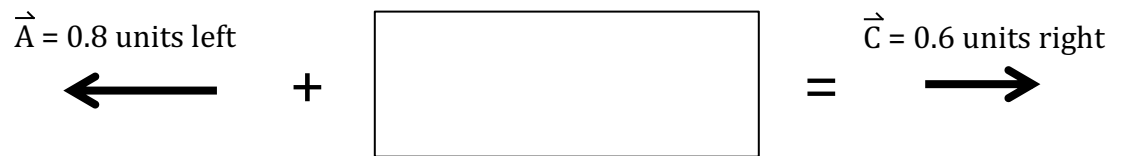
$$\vec{A} = 0.8 \text{ units left} \quad + \quad \boxed{\phantom{\vec{B}}} \quad = \quad \vec{C} = 0.6 \text{ units right}$$

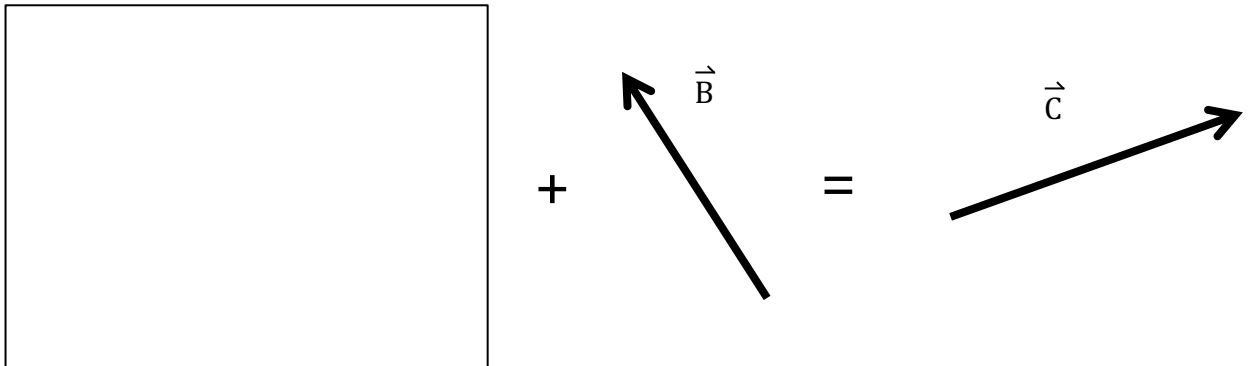
$$\boxed{\phantom{\vec{A}}} \quad + \quad \vec{B} \quad = \quad \vec{C}$$

Discussion 1 Exercises
 Physics 103 – General Physics

9) Another technique that you might find quite useful for this course is called “proportional reasoning.” If you have an equation that relates two variables, this should allow you to determine how one variable changes in response to changes in the other variable without having to do any calculations. Consider the following four equations that relate V and R. Use each to fill out a column in the table below

$$V_1 = \frac{R}{9}$$

$$V_2 = \frac{9R^2}{\sqrt{10}}$$

$$V_3 = \frac{3\pi R^3}{2}$$

$$V_4 = \frac{2}{7R}$$

If you...	V ₁ changes by this factor	V ₂ changes by this factor	V ₃ changes by this factor	V ₄ changes by this factor
Multiply R by 2				
Multiply R by 3				
Multiply R by 5				
Multiply R by 1/2				
Multiply R by 1/3				

1-D Kinematics with Constant Velocity – Group Sheet
Physics 103 – General Physics

1) You decide to jog around Chamberlin Hall. You start at the University Ave entrance and run all the way around until you are back where you started. What can you say about your average speed and average velocity during the trip?

- a) Your average speed is greater than zero and your average velocity is equal to zero.
- b) Your average speed is equal to zero and your average velocity is greater than zero.
- c) Your average speed and average velocity are both equal to zero.
- d) Your average speed is less than zero and your average velocity is equal to zero.
- e) Your average speed is equal to zero and your average velocity is less than zero.

2) An object begins at $x = 7$ m and stops at $x = -3$ m. Which of the following is true?
Select more than one answer if appropriate.

- a) The object moved through $x = 0$.
- b) The object's displacement was +4.
- c) The object's velocity was never positive.
- d) The object moved left.
- e) The object's average velocity was negative.

3) What does it mean when a person's velocity is negative?

- a) The person's speed is negative.
- b) The person is moving in the negative- x direction.
- c) The person is moving toward the left.
- d) The person is moving toward the origin of the coordinate system.
- e) The direction of the person's motion is opposite to the direction they are facing.

1-D Kinematics with Constant Velocity
Physics 103 – General Physics

Useful Expressions:

$$\Delta x \text{ (displacement)} = x_{\text{final}} - x_{\text{initial}}$$

$$\text{average speed} = \frac{\text{total distance}}{\text{total time}}$$

$$v_{\text{avg},x} \text{ (average velocity)} = \frac{\text{total displacement}}{\text{total time}} = \frac{x_{\text{final}} - x_{\text{initial}}}{t_{\text{final}} - t_{\text{initial}}} = \frac{\Delta x}{\Delta t} \quad x = x_0 + v_x t$$

Reflect on the experience you've had so far with today's topic. What sorts of notes might you want to write on a note sheet for the exam (which you can test out by using for the rest of the worksheet and on this week's homework and quiz too)?

4) In the oldest word problem in human history,* train 1 leaves Sparta at a speed of **50 km/hr** heading for Athens, **150 km away**. Train 2 leaves Athens at exactly the same time heading for Sparta at a speed of **75 km/hr**.

A) Draw a picture of the situation at the moment each train is leaving its respective station. Choose a point on the tracks as $x = 0$, note the positive- x direction, and specify the initial location of each train.

B) Use the information from your picture to write down an equation for the position of each train (x_1 and x_2) as a function of time.

Train 1

$x_1 =$

|

Train 2

$x_2 =$

*See Aristotle, *Trains Won't Be Invented for 2000 Years and Other Essays*.

1-D Kinematics with Constant Velocity
Physics 103 – General Physics

C) When the two trains meet, which of the variables in these equations have the same value?

D) Solve each equation for one of the variables you identified in C and set the two resulting equations equal to one another (essentially eliminating this common variable).

E) Now solve for the remaining common variable you identified in C. Then use your result and one of the equations from B to solve for the other common variable from C.

F) When and where do the trains meet?

t = distance from
Sparta = distance from
Athens =

G) In what ways was this question the same as the tortoise and the hare question from lecture? In what ways was it different?

1-D Kinematics with Constant Velocity
Physics 103 – General Physics

H) Draw the plots of the positions of both trains as a function of time on the following grid.

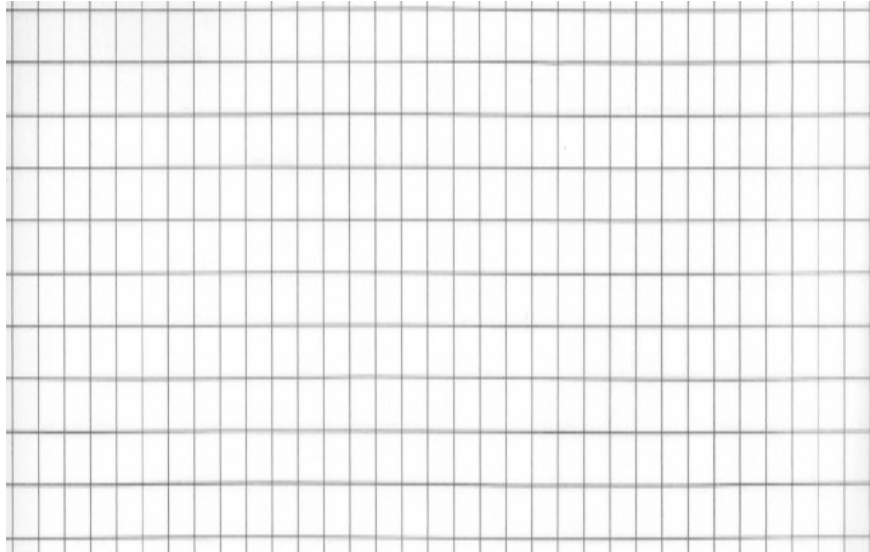

I) How can you identify the time and position where the two trains meet from this graph?

5) Consider an object whose motion is depicted in the graph to the right.

A) What is the object's displacement between $t = 0$ and $t = 6$ s? (Remember to specify magnitude and direction.)

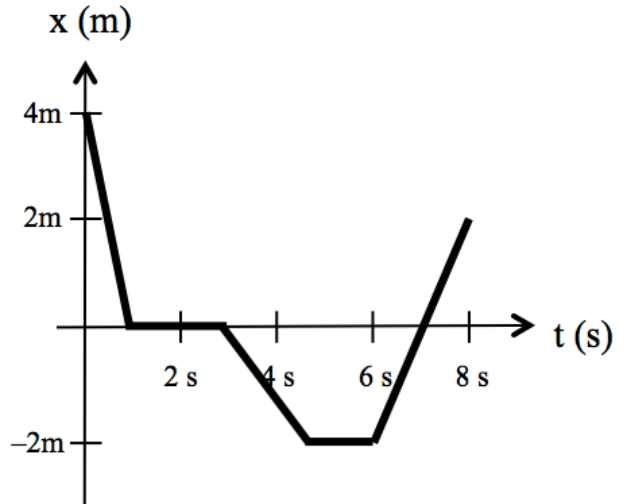

B) What is the object's average velocity between $t = 0$ and $t = 6$ s? (Remember to specify magnitude and direction.)

1-D Kinematics with Constant Velocity

Physics 103 – General Physics

C) Between $t = 0$ and $t = 6$ s, when does the object have the greatest speed? Is this speed larger or smaller than the magnitude of the average velocity?

D) What distance does the object travel between $t = 0$ and $t = 6$ s?

E) What is the object's average speed between $t = 0$ and $t = 6$ s?

F) Compare the object's average speed and the magnitude of its average velocity between $t = 0$ and $t = 6$ s. If they are different, why? If they are the same, why?

G) Find the magnitude and direction of the object's average velocity from $t = 0$ to $t = 8$ s.

H) Find the object's average speed from $t = 0$ to $t = 8$ s. Is this larger or smaller than the magnitude of the average velocity you found in G? Explain why it is larger or smaller.

1-D Kinematics with Constant Velocity
Physics 103 – General Physics

6) Below are two graphs of an object's motion. The first shows the **change in the object's position with time**. The second shows the **change in the object's velocity with time**.

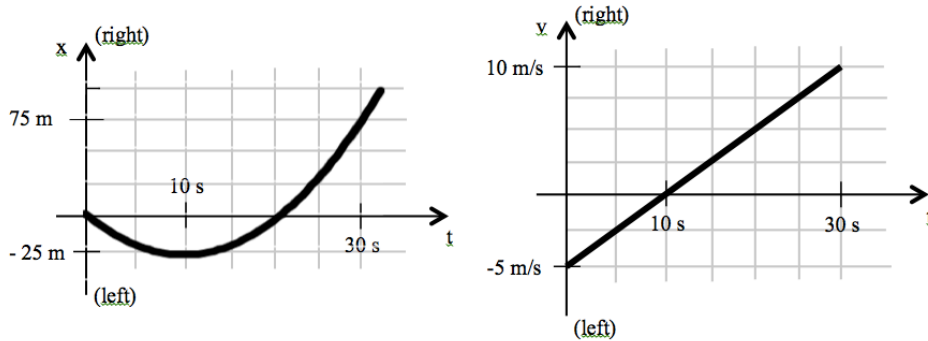

A) Describe the motion of the object at $t = 0$ s.

B) Describe the motion of the object at $t = 10$ s.

C) Describe the motion of the object at $t = 30$ s.

D) In a few sentences describe the total motion of the object from 0 s to 30 s.

Your group member names:

1-D Kinematics with Constant Acceleration – Group Sheet
Physics 103 – General Physics

- 1) If you throw a ball downward, what is its acceleration?
- a) Less than 9.8 m/s^2 down
 - b) Equal to 9.8 m/s^2 down
 - c) More than 9.8 m/s^2 down
- 2) If you throw a ball up in the air, when is it in free fall?
- a) After it reaches maximum height and starts falling
 - b) When it is rising and falling, but not at its maximum height, when it isn't moving
 - c) From the moment it leaves your hand until it hits the ground
 - d) If you throw it, it will never be in free fall

3) Over a period of 16 seconds, an object experiences a constant acceleration, a . At $t = 0$, the object has a velocity of 5 m/s to the left. At $t = 16 \text{ s}$, the object has a velocity of 3 m/s to the right. Which of the following statements about the object is true?

- a) $\Delta v = 8 \text{ m/s}$ to the right and $a = 0.5 \text{ m/s}^2$ to the right
- b) $\Delta v = 8 \text{ m/s}$ to the left and $a = 8 \text{ m/s}^2$ to the left
- c) $\Delta v = 0.5 \text{ m/s}$ to the left and $a = 8 \text{ m/s}^2$ to the right
- d) $\Delta v = 8 \text{ m/s}$ to the left and $a = 0.5 \text{ m/s}^2$ to the left
- e) $\Delta v = 0.5 \text{ m/s}$ to the right and $a = 0.5 \text{ m/s}^2$ to the right

4) In the Fliplt bridge set on acceleration, we asked you to describe the difference between the motion of the uninjured person's hand and the motion of injured person's hand given the two graphs to the right.

Share your description with your group mates.

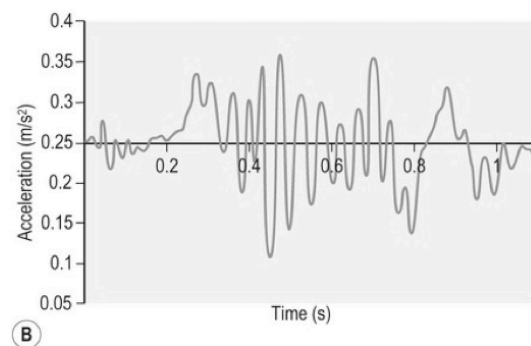
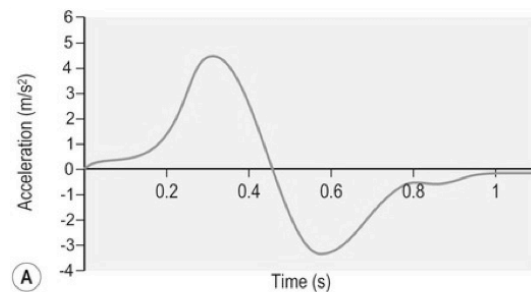

1-D Kinematics with Constant Acceleration
Physics 103 – General Physics

Useful Expressions:

$$v_x = v_{x,0} + a_x t$$

$$x = x_0 + v_{x,0} t + (1/2) a_x t^2$$

$$v_x^2 = v_{x,0}^2 + 2a_x(x - x_0)$$

Reflect on the experience you've had so far with today's topic. What sorts of notes might you want to write on a note sheet for the exam (which you can test out by using for the rest of the worksheet and on this week's homework and quiz too)?

5) The following graph shows the position vs. time for a moving object. Circle the region where the magnitude of the acceleration of the object is largest. You can assume that the object's acceleration is always constant or zero.

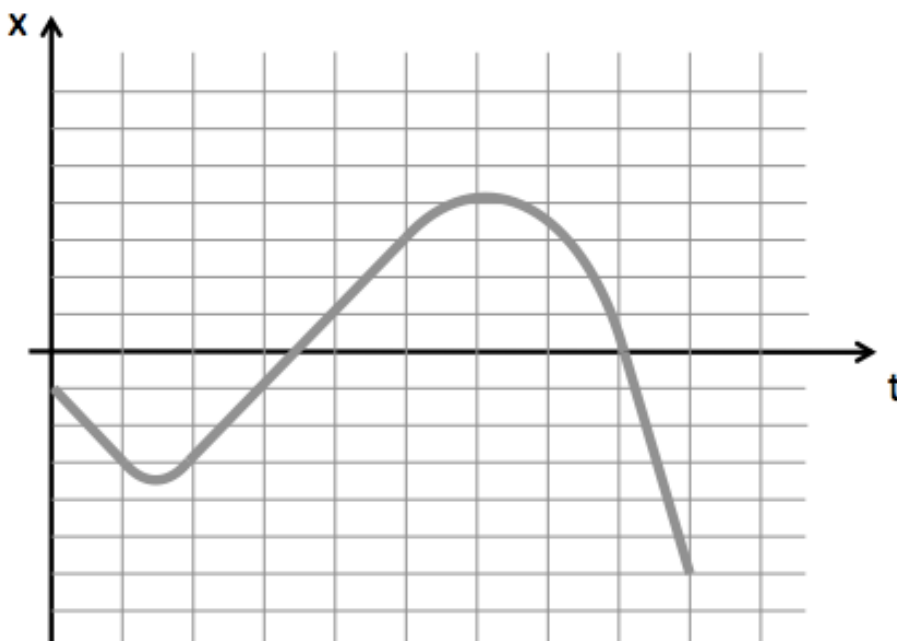

1-D Kinematics with Constant Acceleration
Physics 103 – General Physics

6) You are part of a research team doing experiments on how certain biological processes in cells respond to zero-g conditions. You decide to put your experiment in a rocket, launch it, and then let it fall. During the period between the engines shutting off and returning to the ground – that is, when it is in free fall – the rocket payload will experience zero-g (you'll understand why in a couple of weeks). You've managed to locate a company selling a rocket that will maintain an **upward acceleration of 39.2 m/s^2 for 5 seconds**, after which point your experiment will separate from the rocket and will be in free fall. In order for your experiment to work, **you need it to be in free fall for at least 1 minute.**

Should your team purchase this rocket? To decide, we're going to proceed step by step. This may not be the way you would solve this problem, but it is one way. And if you can come up with your own method, then you have two ways to reach a solution and can choose the best parts of each when you've confronted by a similar situation.

- (1) The rocket engine ignites on the launch pad. (2) The capsule separates from the rocket engine.

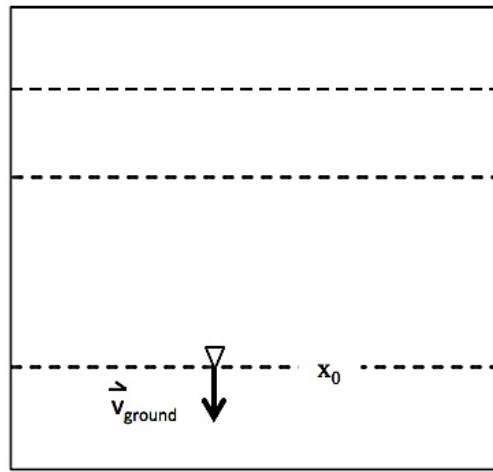
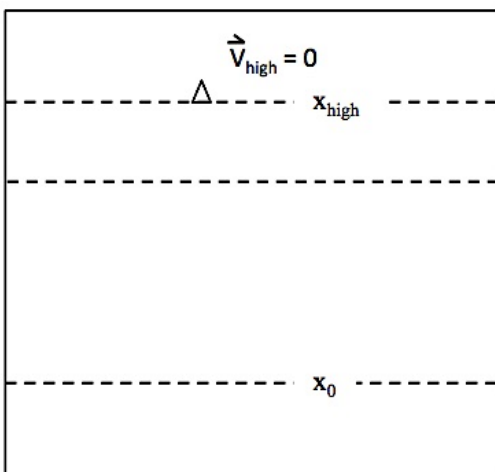
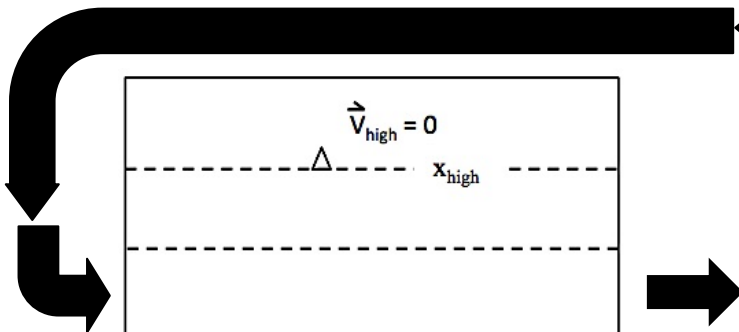
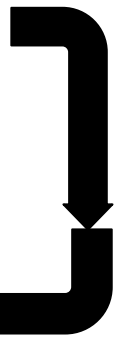
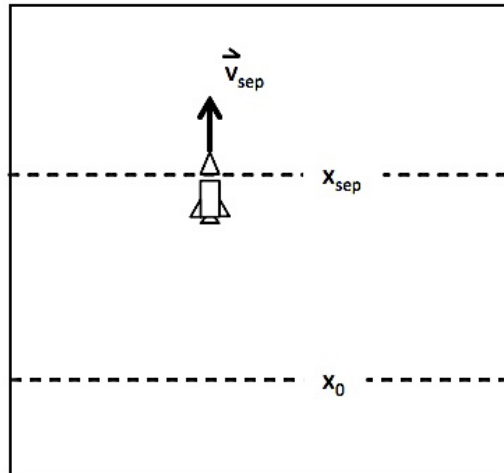
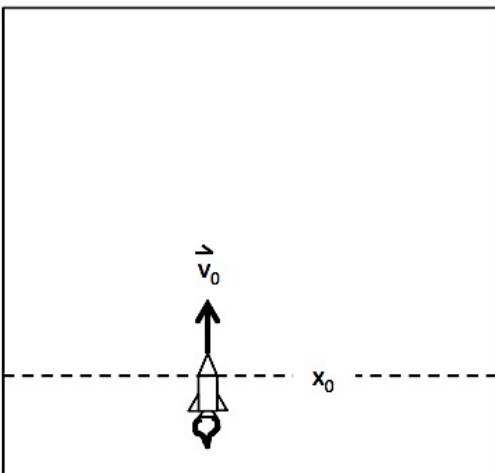

- (3) The capsule reaches its highest altitude.

- (4) The capsule is just about to hit the ground.

1-D Kinematics with Constant Acceleration
Physics 103 – General Physics

E) How could you find $\Delta t_{3 \rightarrow 4}$? This is a little more challenging than finding $\Delta t_{2 \rightarrow 3}$. Once again, when you have a method, use it.

HINTS:

- You know the initial velocity of the capsule at its high point, v_{high} , but you don't know its final velocity, v_{ground} , or the height from which it falls, x_{high} . You'll need one of these. Which is easier to find?
- Solving for the unknown you need (the one from the previous hint) will require a two-step process.

F) Graph the capsule's acceleration and velocity on the following graphs. Make sure to label the a , v , and t axes with specific numbers.

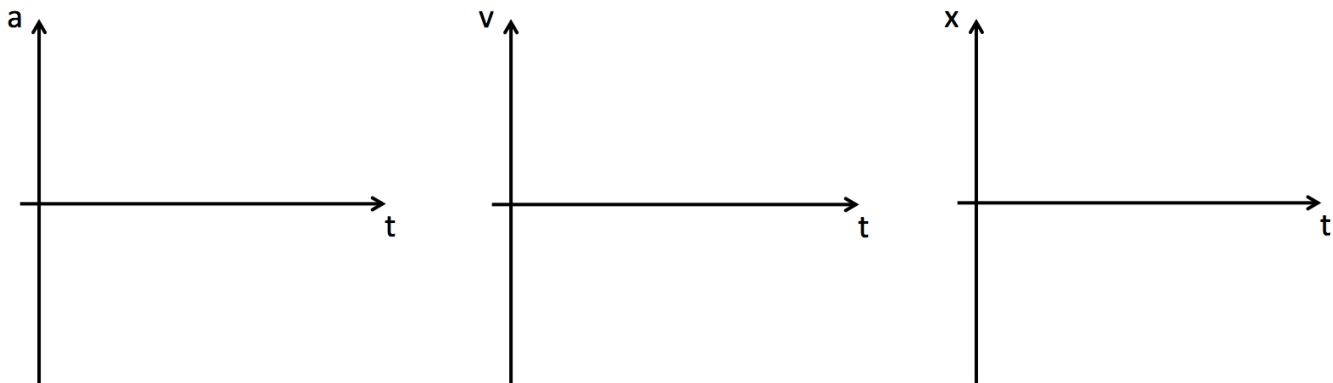

G) Sketch what you think the graph of the height of the capsule containing your experiment (x) vs. time (t) above. Don't worry if you're uncertain – do your best to imagine what is happening to the rocket's distance above the ground.

H) Should you buy this rocket?

7) You and a friend are having a water balloon fight. You climb a tree (19.6 m high) and wait for your friend to walk by. When he does, you decide that in order to achieve aquatic superiority, you want to hit him with two water balloons at the same time. You have one balloon set to go. It will take you a second (1 s) to get the other one out of your bag. So you decide to toss the first balloon into the air, giving you time to get the second balloon ready and then drop it normally.

A) At what velocity do you have to throw the first balloon up to have enough time to prepare and drop the second one?

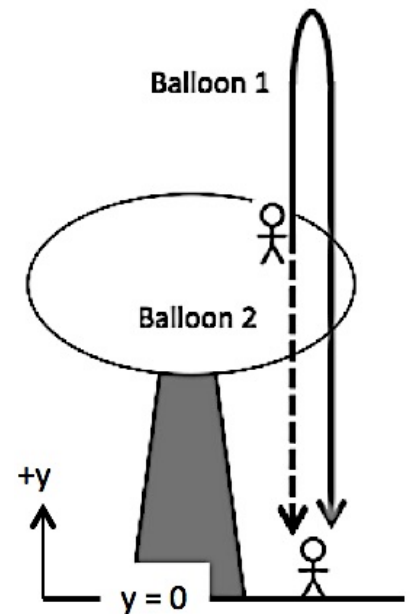

If you get stuck, consider the following hints:

- This problem hinges on time. So write an equation for the position of the balloons as functions of time.
- When the first balloon hits your friend, $y = 0$. If you set $y = 0$, can you solve the equation from the previous hint for the balloon's initial velocity? If not, what other piece of information do you need?
- What is the relationship between the time it takes the first balloon to rise and then hit your friend (t_1) and the time it takes the second balloon to fall and hit your friend (t_2)? Can you find one of these two times?

B) The first balloon won't be at its maximum height when you drop the second balloon. How high will it be? Is it higher or lower than its initial position in your hand?

Vectors and 2-D Kinematics – Group Sheet
 Physics 103 – General Physics

Your group member names:

1) An object has the velocity and is experiencing the acceleration shown.

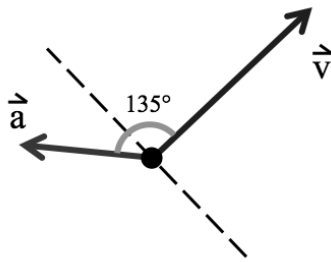

What can you say about its motion in the instant pictured?

- a) It's slowing down and turning clockwise.
- b) It's speeding up and turning clockwise.
- c) It's slowing down and turning counterclockwise.
- d) It's speeding up and turning counterclockwise.

2) You kick a soccer ball toward a high wall with an initial velocity, v_0 , at an angle θ with the horizontal. At which position will the soccer ball hit the wall?

- a) Position 1
- b) Position 2
- c) Position 3

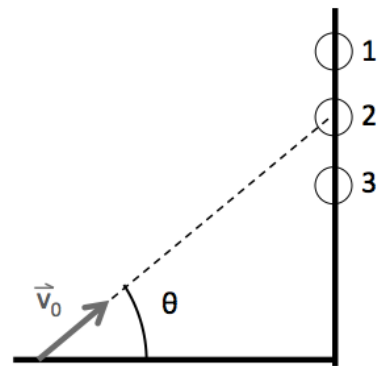

3) A block slides down a frictionless ramp with increasing speed (A). It then goes around a loop, slowing down as it travels (B), finally reaching the top of the loop where it is between slowing down and speeding up. Select the correct direction of the block's **net** acceleration in each position. (Hint: Is the block speeding up or slowing down or neither in each position? In what direction is it turning?)

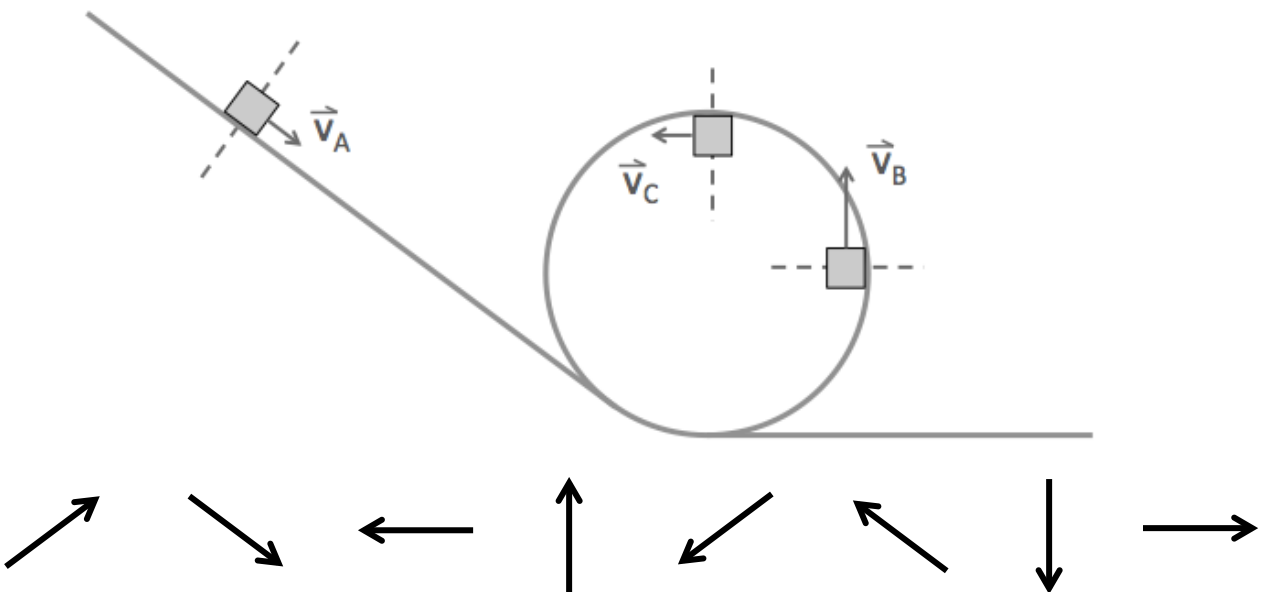

Vectors and 2-D Kinematics
Physics 103 – General Physics

Useful Expressions:

$$v = \sqrt{v_x^2 + v_y^2} \quad v_x = A_x + B_x \quad v_y = A_y + B_y$$

Constant acceleration:

$$y = y_0 + v_{0y}t + (1/2)at^2 \quad v_y = v_{0y} + at \quad v_y^2 = v_{0y}^2 + 2a_y\Delta y$$

Constant velocity: $x = x_0 + v_{0x}t$

Reflect on the experience you've had so far with today's topic. What sorts of notes might you want to write on a note sheet for the exam (which you can test out by using for the rest of the worksheet and on this week's homework and quiz too)?

4) Imagine you're at a carnival and decide to play a game. You want to hit the center of a target 3 m away by throwing a bean bag. For your first attempt, you aim at the exact center of the target (which we'll say is at a horizontal height of $y = 0$) and throw the bean bag at a horizontal velocity of $v_0 = 15$ m/s. (Note that for the rest of this problem, we'll assume that $+y$ is up.)

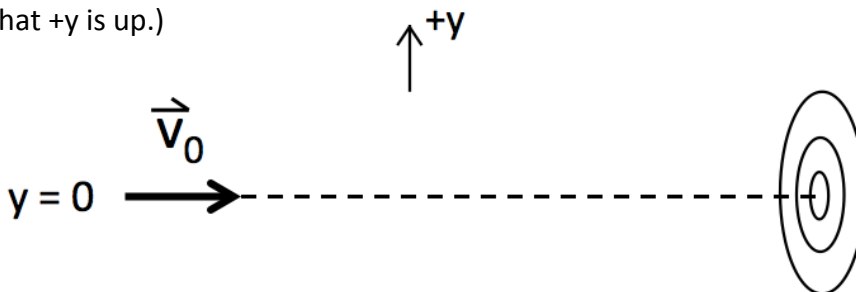

A) Will you hit the exact center of the target? Why or why not?

B) Draw the trajectory of the bean bag on the picture above.

Vectors and 2-D Kinematics
Physics 103 – General Physics

C) To find how far the bag drops from its initial position on its way to the target, you could use $y = y_0 + v_{0y}t + (1/2)a_yt^2$ where y is how far below the target the bag will strike. Fill in the following boxes. (Remember to pay attention to signs.)

$y_0 =$ $v_{0y} =$ $a_y =$

D) You also need a value for t (the time between you throwing the bag and it hitting the target). How can you find t ?

E) Find t according to the method you outline in D and calculate a value for y . By how much do you miss the target?

F) Would you hit the center of the target if the target dropped at the same moment you threw the bean bag?

5) You are standing on top of a hill that is 8 m high. You want to kick a soccer ball down to your friend who is at the bottom of the hill below you. You kick the soccer ball at a 60° angle the horizontal.

Suppose it takes 2.5 s for the ball to reach your friend. In that case, we want to know the horizontal distance between you and your friend.

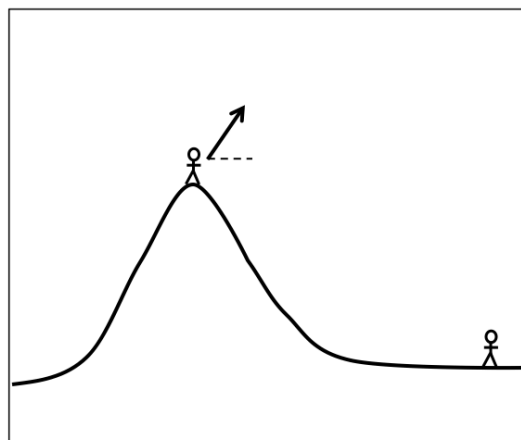

A) Start by drawing a coordinate system on the diagram above. Indicate which direction is the positive x direction and which is the positive y direction.

Vectors and 2-D Kinematics
Physics 103 – General Physics

B) Which of the following variables are knowns and which are unknowns? Circle the correct choice. Also indicate which one the question is actually asking you to find.

Height of the hill	Known / Unknown	Asked to find: Y / N
Horizontal distance between you and your friend	Known / Unknown	Asked to find: Y / N
Angle at which you kick the ball	Known / Unknown	Asked to find: Y / N
Initial velocity at which you kick the ball	Known / Unknown	Asked to find: Y / N

C) Indicate all these variables on the diagram.

D) Write an equation for the horizontal distance the ball travels in time t . Can you solve this equation for the distance if $t = 2.5$ s? What other variable do you need to know?

E) Since you aren't able to solve the problem in the horizontal direction only, you'll need to think about what you can get from motion in the vertical direction. Write an equation for the vertical position of the ball at time t . If $t = 2.5$ s, can you solve this equation for any unknown?

F) Combine your results from D and E to find the horizontal distance the ball travels in 2.5 s.

Vectors and 2-D Kinematics
 Physics 103 – General Physics

6) An object has an initial position vector, \vec{d}_0 , as shown below. It also has a velocity, \vec{v} , also shown. Each gridline in the first graph represents 1 m. Each gridline in the second graph represents 1 m/s.

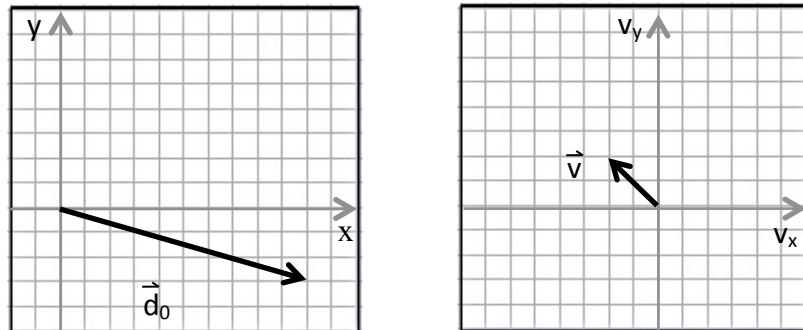

A) Draw the position vector of the object at the following times.

$t = 1 \text{ s}$

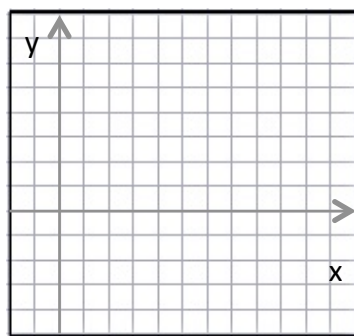

$t = 2 \text{ s}$

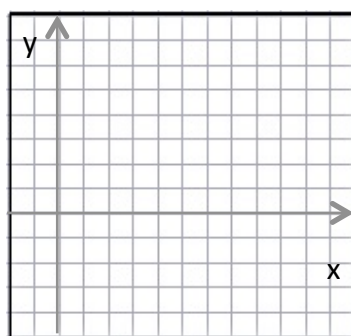

$t = 3 \text{ s}$

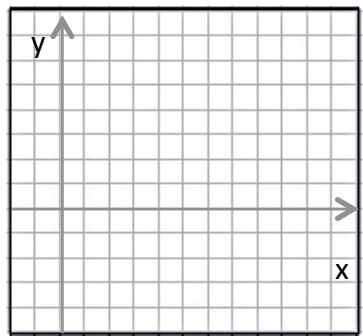

$t = 4 \text{ s}$

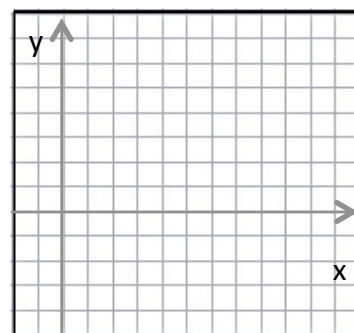

$t = 5 \text{ s}$

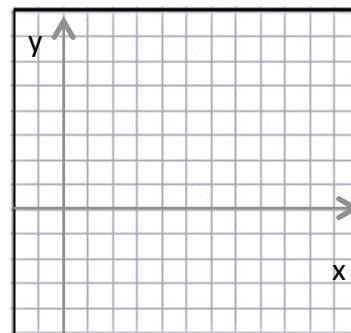

B) Describe the motion of the object in your own words. What kind of path is it following? Is it speeding up or slowing down?

Vectors and 2-D Kinematics
Physics 103 – General Physics

7) Now that you are a recognized authority on projectile motion, you are approached by the Agents of P.H.I.S.I.C.S.* about a carnival game similar to the one you analyzed in question 5. In this case, players pay to shoot an air rifle that has been fixed to make a 0° angle with the horizontal and is 1 meter off the ground. It is aimed at a target, also 1 meter off the ground. The player shoots when she sees the target start to fall (a situation very much like you dealt with in question 5, part F). If she hits it, she wins a prize. If she doesn't hit it, she loses. Unfortunately, reports are pouring in that everyone who plays the game loses. You need to determine two things:

- A) Are the complaints valid? Should this game be unwinnable?
- B) If the game shouldn't be unwinnable, how might it have been modified to make it so?
- C) What could you do to test out the ideas you generated in B?

Newton's 1st and 2nd Laws – Group Sheet
Physics 103 – General Physics

Your group member names:

1) An object is moving left at a steadily reducing velocity until it comes to a halt and then starts to move to the right faster and faster. In which direction is its acceleration?

- a) Right
- b) Left
- c) Right when it is moving left and to the left when it is moving right
- d) Left until it stops and then right as it speeds up
- e) Right when it is moving left, zero when it stops, and right when it is moving right

2) When can the total external force on an object be in a different direction from the acceleration of the object?

- a) When the object is falling
- b) When the object is in equilibrium
- c) When there is more than one force on the object
- d) When the object is acted on by gravity
- e) Never

3) How large a force do you need to exert on a 5 kg object that is initially at rest to give it a velocity of 7 m/s in 4 s?

- a) 8.75 N
- b) 12.9 N
- c) 21.2 N
- d) 1.75 N
- e) 0.54 N

4) Which of the following best matches the free body diagram of a projectile in flight?

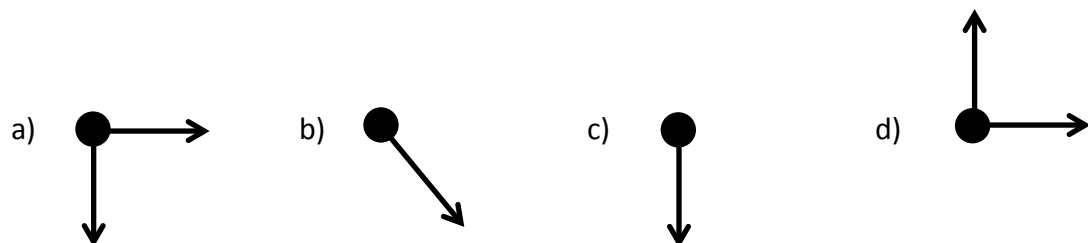

Newton's 1st and 2nd Laws
Physics 103 – General Physics

Useful Expressions:

$$\Sigma \vec{F}_{\text{ext}} = \vec{F}_{\text{net}} = m\vec{a} = m \frac{\Delta \vec{v}}{\Delta t}$$

$$\vec{W} = m\vec{g} \text{ (weight)}$$

Reflect on the experience you've had so far with today's topic. What sorts of notes might you want to write on a note sheet for the exam (which you can test out by using for the rest of the worksheet and on this week's homework and quiz too)?

5) Suppose a block of $m = 10 \text{ kg}$ is at the bottom of an frictionless inclined plane, tilted at an angle of $\theta = 40^\circ$. It is given a push so that it has an initial velocity of 8 m/s .

A) Draw a free body diagram of the block when it is at the bottom of the plane.

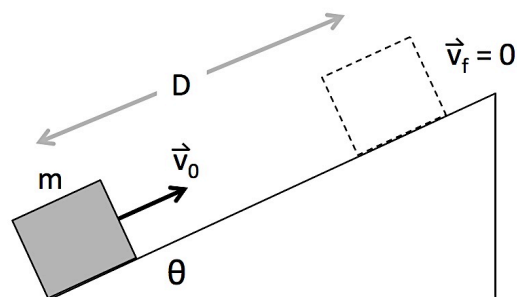

B) Draw a free body diagram of the block when it is stopped momentarily at the top of the plane. Is your picture here different than your picture in A? If so, how?

Newton's 1st and 2nd Laws
Physics 103 – General Physics

C) On its trip up the plane, what is the component of the gravitational force on the block parallel to the surface of the plane?

D) What acceleration does the block experience as it moves up the plane?

E) Use the kinematic equations you know for an object undergoing constant acceleration to find how far a distance along the surface of the plane (denoted by D in the diagram above) the block travels.

F) You were given one parameter in the initial question that you didn't need to find an answer for part E. Which one was it?

6) When you walk, your heel strikes the floor with a velocity, v , pointed downward and in the direction in which you are walking.

The floor must exert contact forces that reduce the motion of your heel to zero – if the vertical component of your heel's velocity remained your foot would crash through the floor and if the horizontal component remained you'd slip.

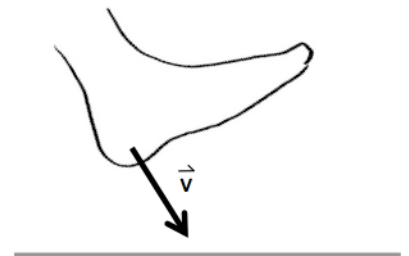

A) Of the three contact forces that you learned about in Fliplt (Normal force, Friction, and Tension), which do you think the floor will exert to stop the vertical motion of your foot? Justify your answer.

Newton's 1st and 2nd Laws
Physics 103 – General Physics

B) Which kind of contact force you think the floor would exert to stop the horizontal motion of your foot? Again, justify your answer.

C) What is the net direction of the combined force (vertical + horizontal) that the floor exerts on your heel? How does this direction relate to the direction of your heel's velocity?

7) An Atwood's Machine is a device composed of two masses (not necessarily equal) connected by a string over a pulley. For the remainder of our discussion, we'll assume that the pulley is "massless" (that is, it doesn't require any effort to turn) and that the string doesn't stretch and is always taut. **We want to derive an expression for the motion of m_1 .**

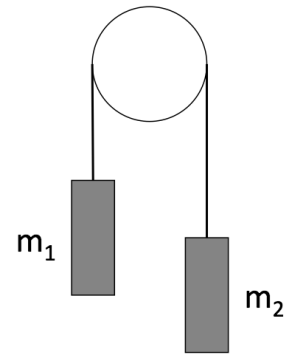

A) Start by drawing a free body diagram of each mass. You can call the tension in the string T . Note that both ends of the string will exert the same tension force on the masses. (You'll see why next week.)

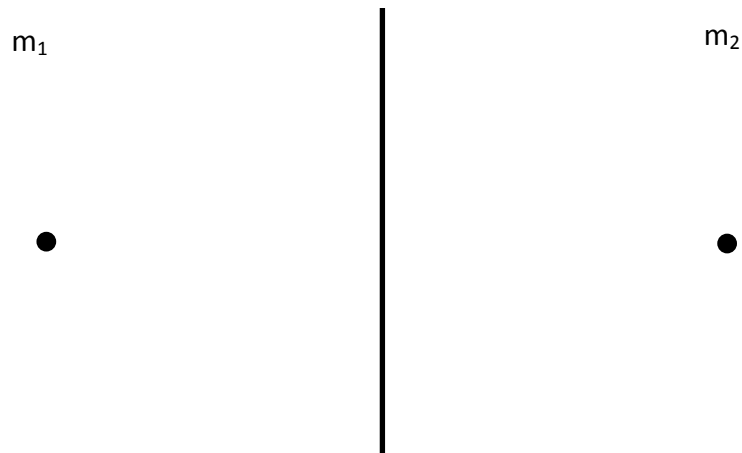

B) In order to compare equations of motion applied to m_1 with those applied to m_2 , we need to orient ourselves. That means establishing a coordinate system. Check the way you want to orient your coordinates for this problem

Up for m_1 is positive, down for m_2 is positive

Down for m_1 is positive, up for m_2 is positive

Newton's 1st and 2nd Laws
Physics 103 – General Physics

- H) What is the acceleration of m_1 ? In what direction will this acceleration be if $m_1 > m_2$? In what direction will it be if $m_1 < m_2$? What happens if $m_1 = m_2$?
- 8) On a trip to the Colorado Rockies, you notice that when the freeway goes steeply down a hill, there are emergency exits every few miles. These emergency exits are straight ramps which leave the freeway and are sloped uphill. They are designed to stop runaway trucks and cars that lose their brakes on downhill stretches of the freeway even if the road is covered with ice. You are curious, so you stop at the next emergency exit to take some measurements. You determine that the exit rises at an angle of 10° from the horizontal and is 100 m long. What is the maximum speed of a truck that you are sure will be stopped by this road, even if the frictional force of the road surface is negligible?

Newton's Third Law of Motion – Group Sheet
Physics 103 – General Physics

Your group member names:

1) You're lifting a bucket full of water up from the bottom of a well at a constant speed of 0.25 m/s. You stop to take a rest. How much does the tension in the rope decrease when you're resting compared to when you were moving the bucket upward?

- a) The tension is half.
- b) The tension is 0.25 times.
- c) The tension is double.
- d) The tension is the same.
- e) The tension is zero.

2) Below is a free body diagram of the bucket carrying the water. Which of the forces shown are Third-Law pairs? ($N_{\text{water,bucket}}$ is the normal force the water exerts on the bottom of the bucket.)

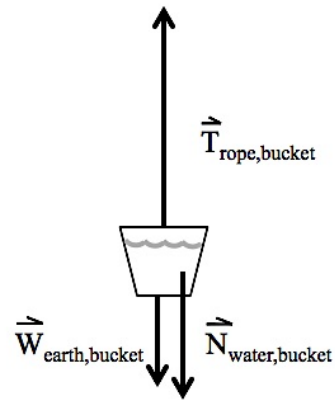

- a) $T_{\text{rope,bucket}}$ and $W_{\text{earth,bucket}}$
- b) $T_{\text{rope,bucket}}$ and $N_{\text{water,bucket}}$
- c) $W_{\text{earth,bucket}}$ and $N_{\text{water,bucket}}$
- d) $T_{\text{rope,bucket}}$ and the sum of $W_{\text{earth,bucket}} + N_{\text{water,bucket}}$
- e) There are no Third-Law pairs in this diagram.

3) What is a Third-Law paired force to any one of the forces in the diagram above?

- a) The normal force of the bottom of the bucket up on the water.
- b) The gravitational force of the water in the bucket on the bucket.
- c) The gravitational force of the water in the bucket on the earth.
- d) The tension in the rope pulling up on the bucket.
- e) The tension in the rope pulling on your hands.

Newton's Third Law of Motion
Physics 103 – General Physics

Useful Expressions:

$$\Sigma \vec{F}_{\text{ext}} = m\vec{a} \quad \vec{W} = m\vec{g} \quad \vec{F}_{A,B} = -\vec{F}_{B,A}$$

Reflect on the experience you've had so far with today's topic. What sorts of notes might you want to write on a note sheet for the exam (which you can test out by using for the rest of the worksheet and on this week's homework and quiz too)?

4) You are pulling a crate with mass m_1 of 20 kg along the floor with force F of 15 N. There is a smaller crate with mass m_2 resting on top of the first crate. The two crates are together accelerating in the direction of F , as shown to the right. There is a force of friction between the first crate, m_1 , and the floor that amounts to 5 N. The frictional force that m_1 exerts on m_2 is 2 N. **You need to find the mass of m_2 .**

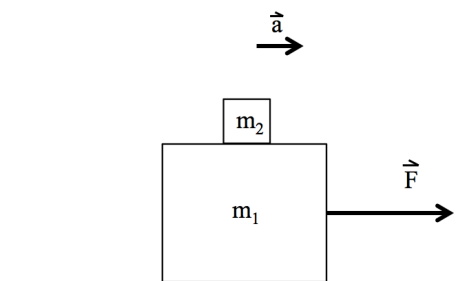

A) This is a complicated problem, but we'll start the same way we always start any force problem: by drawing free body diagrams. **Since we're interested in m_2 , draw a free body diagram of m_2 .** There will be *three forces* on m_2 : $W_{E,2}$ (the weight of $m_2 = m_2g$ due to the Earth's gravity), $N_{1,2}$ (the normal force exerted by m_1 on m_2), and $f_{1,2}$ (the friction force that m_2 feels from the surface of m_1).

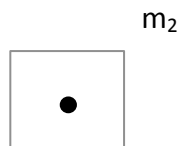

Newton's Third Law of Motion
Physics 103 – General Physics

B) You know that m_2 is moving along with m_1 . What force is responsible for accelerating m_2 ? Does this make sense to you?

C) Add up the vertical and horizontal forces on m_2 and set each equal to m_2 times the vertical and horizontal accelerations respectively.

Vertical forces

=

Horizontal forces

=

D) Are you able to find m_2 from these equations? What would you need to know in order to find m_2 ?

Newton's Third Law of Motion
 Physics 103 – General Physics

E) Since we can't get any further with just focusing on m_2 , let's look at m_1 . Here's a diagram already started below for m_1 . Fill in the correct forces in the boxes from the list at the right.

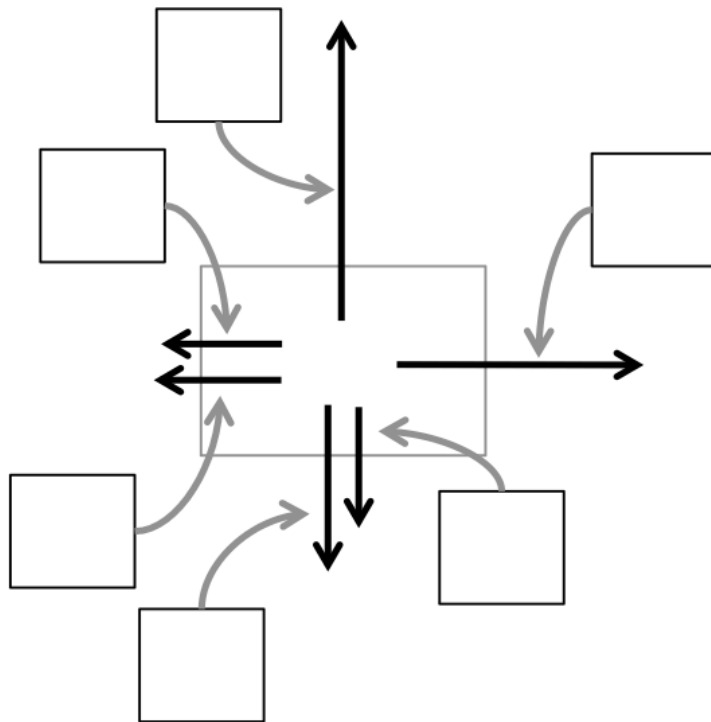

$F_{\text{You},1}$ = force with which you are pulling m_1

$N_{F,1}$ = normal force exerted on m_1 by the floor

$W_{E,1}$ = weight of m_1 (that is, the force that Earth's gravity pulls down on m_1)

$N_{2,1}$ = normal force exerted by m_2 on m_1

$f_{F,1}$ = friction force exerted by the floor on m_1

$f_{2,1}$ = friction force exerted on m_1 by m_2

F) Which of these forces are part of an a Third-Law pair with forces on m_2 ?

G) Add up the vertical and horizontal forces on m_1 . Do you see any way to solve for the variable you identified in D? If so, go ahead and find it.

Vertical forces = *Horizontal forces* =

Newton's Third Law of Motion
Physics 103 – General Physics

H) Now use everything you know to solve for m_2 .

HINTS:

- Think about your conclusion from part D. What do you need to find to determine m_2 ?
- Which of the equations above helps you find the thing you need to determine m_2 ?
- Write down your knowns and unknowns. Note that the initial problem doesn't give you variable names, only descriptions. You have to match those descriptions to the variable names.

I) For good measure, find the magnitude of $N_{F,1}$.

Newton's Third Law of Motion
 Physics 103 – General Physics

5) Suppose we have two masses, m_1 and m_2 , arranged as shown to the right. The angle of the incline is θ . A massless string connects m_1 and m_2 . A second massless string connects m_2 to the top of the incline. (Yes, we're just working with variables here, no numbers.) **We'd like to know what is the tension in the second string.**

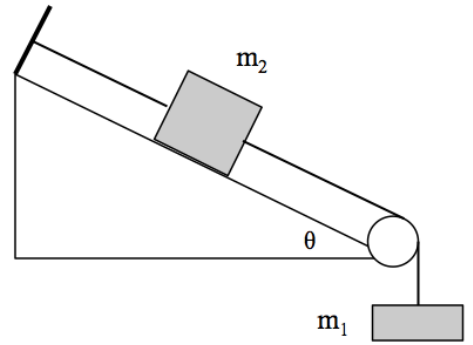

A) Draw free body diagrams for both masses.

m_2



m_1



B) Do you think the tension in the first string should equal the tension in the second string? Make a prediction.

C) Add up the forces for m_1 and m_2 . What do these sums equal?

Vertical (m_1)

	=	
--	---	--

Horizontal (m_1)

	=	
--	---	--

Parallel to the plane (m_2)

	=	
--	---	--

Perpendicular to the plane (m_2)

	=	
--	---	--

Newton's Third Law of Motion
Physics 103 – General Physics

D) Use these equations to solve for the tension in the string connecting m_2 to the top of the incline in terms of m_1 , m_2 , and θ . Is it the same as the tension in the string connecting m_1 and m_2 ?

E) What happens to the tension in the two strings if we change the angle of the incline and let θ become 90° ? Are they still different? Draw a picture of this situation and see if your result makes sense.

F) Now, let's reduce θ . What happens if we make $\theta = 0^\circ$. What happens to the tensions in the two strings?

G) In your own words, describe the relationship between the tension in the two strings as θ varies from 0° to 90° .

Friction, Drag, and Circular Motion – Group Sheet
Physics 103 – General Physics

1) If an object is moving north at a constant velocity, then which of the following may be true? Select all that apply.

- a) The net external force on the object must be pointed north.
- b) There can only be a single force on the object.
- c) If there are any forces acting on the object, there must be at least two.
- d) There must be at least one force on the object pointed north.
- e) There is no net external force on the object.

2) You are pushing on a table with a horizontal force 196 N but it isn't moving. The coefficient of static friction between the table and the floor is 0.4. Assuming there are no other horizontal forces on the table, which of the following is true? Select all that apply.

- a) The static frictional force acting on the table depends on the force with which you push.
- b) If the table has a mass of 75 kg, then the static frictional force on it is 294 N.
- c) The mass of the table is at least 50 kg but may be more.
- d) The static frictional force acting on the table depends on its weight.
- e) The mass of the table must be 50 kg.

3) An object is moving in a circle at a constant velocity. What can we say about the directions of its velocity, acceleration, and the net force acting on it?

- a) Its velocity and the force acting on it are tangent to the circle and its acceleration is pointed toward the center of the circle.
- b) Its velocity is tangent to the circle and its acceleration and the force acting on it are pointed toward the center of the circle.
- c) Its velocity and the force acting on it are pointed toward the center of the circle and its acceleration is tangent to the circle.
- d) Its velocity, acceleration, and the force acting on it are all tangent to the circle.
- e) Its velocity is tangent to the circle, its acceleration is pointing toward the center of the circle, and there are components of the force acting on it that are both tangent to the circle and pointing toward the center of the circle.

Friction, Drag, and Circular Motion
Physics 103 – General Physics

Useful Expressions:

$$\vec{W} = m\vec{g} \quad \vec{F}_{A,B} = -\vec{F}_{B,A} \quad f_k = \mu_k N \quad f_s \leq \mu_s N$$

If $a = 0$, $F_{\text{net}} = 0$ If uniform circular motion $F_{\text{net}} = ma_{\text{centr}} = m \frac{v^2}{r}$

Otherwise $F_{\text{net}} = ma$

Reflect on the experience you've had so far with today's topic. What sorts of notes might you want to write on a note sheet for the exam (which you can test out by using for the rest of the worksheet and on this week's homework and quiz too)?

4) A block slides down a frictionless ramp and around a loop. Draw a free body diagram for the block at the two positions shown. In each case, the velocity is given and the dotted line is perpendicular to both the velocity and the track on which the block is sliding. In the box next to each position, draw the direction of the net force on the block.

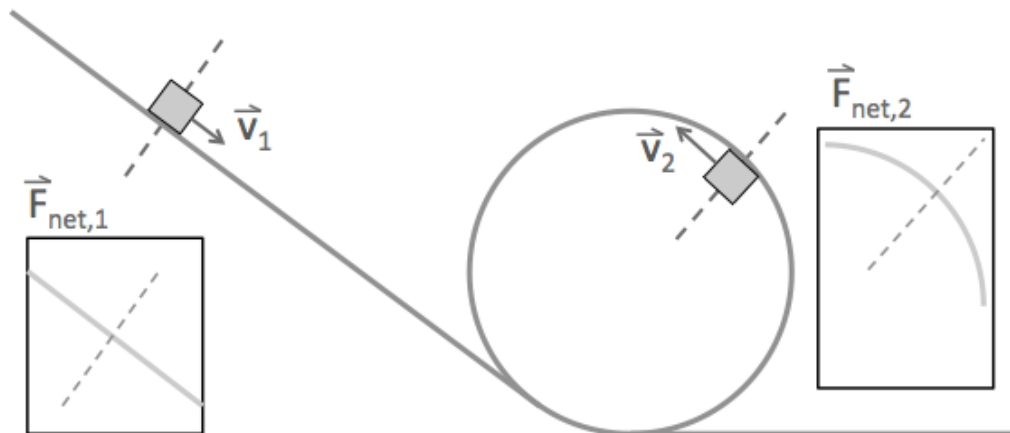

Friction, Drag, and Circular Motion
Physics 103 – General Physics

5) You are pulling a sled with a package on it through the snow with force F as shown. The fully loaded sled has a mass of 20 kg. The coefficient of static friction between the sled and the snow is 0.25. The coefficient of kinetic friction between the sled and the snow is 0.15.

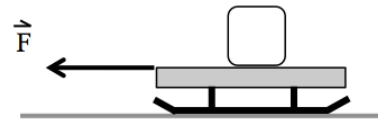

A) Draw the free body diagram of the sled plus package system (as one object). Indicate the frictional force by $f_{\text{SNOW,SLED}}$.



B) Write an expression for the normal force the snow exerts upward on the sled system in terms of the mass of the fully loaded sled.

C) What is the maximum static frictional force that the snow can exert on the sled?

D) What is the frictional force on the sled when $F = 20 \text{ N}$ but the sled has not yet started to move? (It's not your answer to C.)

Friction, Drag, and Circular Motion
Physics 103 – General Physics

E) What is F when the sled starts to move?

F) Once the sled starts moving, how much force do you need to keep it moving at a constant velocity?

G) Suppose you were pulling the moving sled at an upward angle of 30° . Draw a free body diagram of the sled in this case. Will the frictional force due to the snow be more or less than what you found in F?

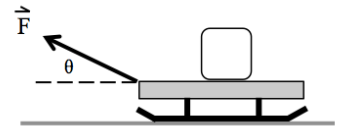

•

Friction, Drag, and Circular Motion
Physics 103 – General Physics

6) Let's think about someone on a swing. In particular, let's imagine what's happening at each of the three points to the right (A, B, and C).

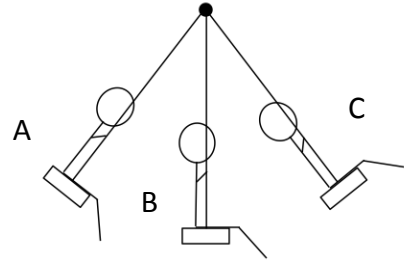

A) Recall the last time you were on a swing. At which position(s) did you feel heaviest? At which position(s) did you feel the lightest?

B) Draw a free body diagram of the person at each position. You can assume the normal force the seat exerts on the person is always along the line between the seat and the central bar (that is, perpendicular to the arc of the swing).

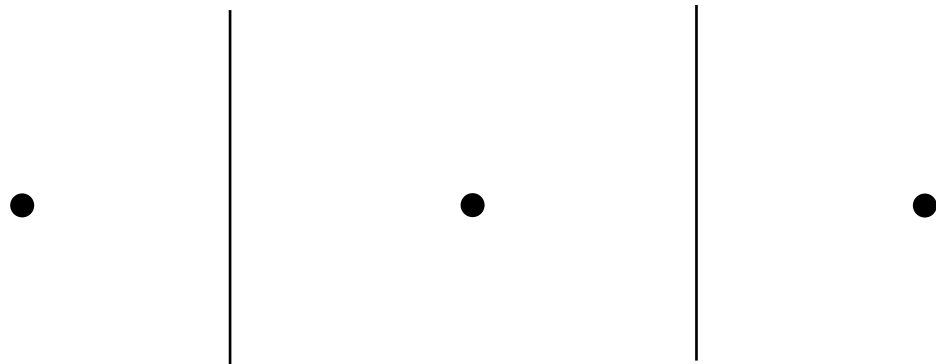

If you're having some trouble, consider the following:

- There are only two forces acting on the person at all times.
- Only one is always in the same direction and has the same magnitude in the three positions.
- The other force changes direction and magnitude.
- One force has nothing to do with the swing
- The other force wouldn't be there if the seat of the swing wasn't there.

Friction, Drag, and Circular Motion
Physics 103 – General Physics

C) What is the net force upwards on the person when they're at the bottom of their arc (position B)? Suppose that the person has a mass of 50 kg and is moving at 2 m/s at position B. Also, the lengths of the chains from the central bar to the swing seat are 3 meters long.

D) Now that you know the net force on the person at position B, calculate the magnitude of the normal force that the swing seat exerts upward on the person. Compare your answer to the person's weight. Does this help you understand why you might feel heavier or lighter at this point in your swing?

E) Consider position A, when the person is momentarily stopped at the height of their arc. If the chains from the central bar to the swing are making a 25° angle with respect to the vertical, what is the normal force the seat exerts on the person? Does your answer explain why you might feel lighter at this position? (Hint: For an instant at A, there won't be any centripetal acceleration, only a tangential one because the velocity isn't changing direction, only magnitude.)

Friction, Drag, and Circular Motion
Physics 103 – General Physics

7) A car is driving around a circular track of radius $r = 200$ m with a banking angle of $\theta = 42$ degrees.

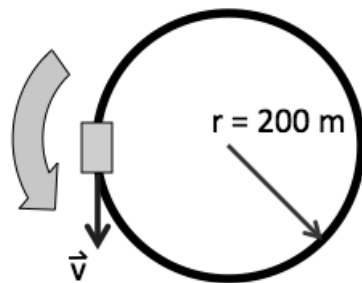

(top view of track)

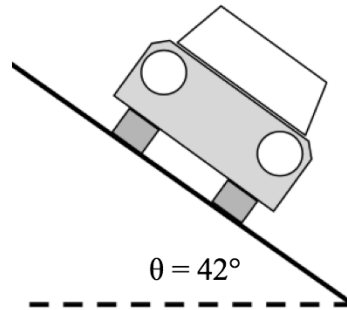

(side view of track)

A) Draw a free body diagram of the car assuming that the car is just coasting around the track at a constant speed. You can assume there is no frictional force between the car's tires and the track.

B) With what magnitude of velocity does the car need to drive around the track if there are no frictional forces between the tires and the track?

C) If the car drives slower than the speed you found in B, there will now be a frictional force up or down the slope of the track. In which direction will this force be pointing?

Work and Energy – Group Sheet
Physics 103 – General Physics

Your group member names:

1) You toss an apple straight up into the air and then catch it. As you're catching it, are you doing positive, negative, or no work?

- a) Positive
- b) Negative
- c) No work

2) As you're catching the apple from question 1, what kind of work does gravity do?

- a) Positive
- b) Negative
- c) No work

3) What can you say about the net work on the apple as you're catching it?

- a) It's positive.
- b) It's negative.
- c) It's zero.

Work and Energy
 Physics 103 – General Physics

Useful Expressions:

$$W = Fd\cos\theta \quad K_{\text{trans}} = \frac{1}{2}mv^2$$

$$W_{\text{net}} = \Delta K = K_f - K_0$$

$$W_{\text{grav}} = -mg\Delta y = -mg(y_f - y_0)$$

$$W_{\text{spring}} = -\frac{1}{2}k(x_f^2 - x_0^2)$$

Reflect on the experience you've had so far with today's topic. What sorts of notes might you want to write on a note sheet for the exam (which you can test out by using for the rest of the worksheet and on this week's homework and quiz too)?

4) A block is on a frictionless surface. One hand on the left side of the block is pushing it to the right. A second hand on the right side of the block is pushing it to the left.

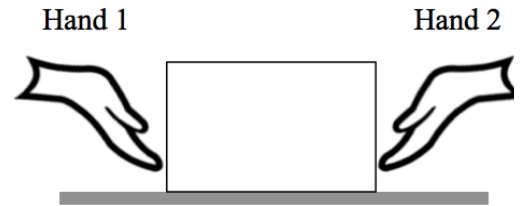

A) For each displacement of the block, circle the appropriate sign to indicate whether the hands are doing positive or negative work:

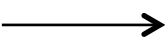
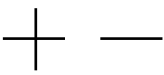
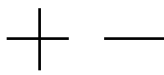
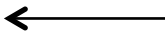
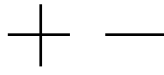
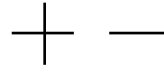
Displacement	Work done by hand 1	Work done by hand 2
		
		

Work and Energy
 Physics 103 – General Physics

B) For each kind of motion, circle the hand that is doing the largest amount of work and the sign of the net work (that is, the sum of all the work) being done on the block. Also indicate whether the total energy of the block is increasing or decreasing.

Motion	Most work done	Net work	KE of block
Moving right and speeding up	H1 H2	+ -	Increasing Decreasing
Moving right and slowing down	H1 H2	+ -	Increasing Decreasing
Moving left and speeding up	H1 H2	+ -	Increasing Decreasing
Moving left and slowing down	H1 H2	+ -	Increasing Decreasing

C) If the block is moving at a constant velocity to the right as both hands push on it, which hand is doing more work?

D) Does your answer change if the block is moving at a constant velocity to the left?

5) Suppose, instead of two hands pushing on the block, we have only one hand pushing to the right. Assume the block starts from rest.

A) If the block has a mass of 2 kg and the hand pushes the block with a force of 10 N for 3 seconds, how much work does the hand do on the block? (Hint: How far does the block travel in those 3 seconds?)

Work and Energy
Physics 103 – General Physics

B) How much kinetic energy has the block gained? (Hint: What is the final velocity of the block?) How does this number compare to your answer to A?

C) Now, imagine the surface over which the block travels is **not** frictionless. If the hand applies 5 N to the box for 5 s and it doesn't move at all, how much work does the force of static friction do to keep the block stationary.

D) If the hand applies 10 N of force for 3 s and the block moves 4.5 m, how much work did the hand do?

E) What would the final kinetic energy of the block be if the only force acting on it for those 4.5 m were from the hand?

F) But remember, there's also friction. So what is the actual final kinetic energy of the block? (Hint: What is the final velocity of the block if it accelerated for 3 s and moved 4.5 m?)

G) What is the difference between these two numbers?

Work and Energy
Physics 103 – General Physics

H) If the coefficient of kinetic friction between the block and the surface it moves over is 0.408, how much work did friction do on the block as it moved 4.5 m? *Go ahead and round your answer to 1 decimal place.*

I) How does your answer to H compare to your answer to G?

J) Fill in the following blank with the word that you think best fits:

Work done by friction energy from the block.

K) Why do you think the statement you created in J is true?

6) Various components in a cell are moved through the cell by motor proteins such as kinesin. The kinesin attaches itself on one end to the component (shown here as a big sphere) and the other end to a tubule (at the bottom of the picture). The kinesin has two "feet" at the bottom that detach, swing forward, and attach again alternately, "walking" the kinesin along the tubule. The component it's dragging is moving through a fluid (water and other chemicals inside the cell), which means the kinesin has to put in energy to counteract the resistive drag force exerted on the component by the fluid. It does so by burning ATP into ADP.

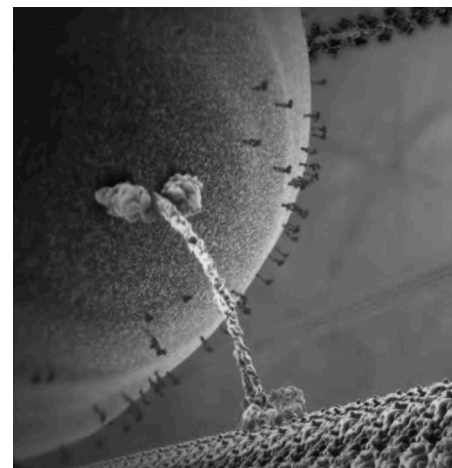

Work and Energy
Physics 103 – General Physics

A) Below is a free body diagram only of the horizontal forces acting on the component, where $F_{\text{kinesin,component}}$ is the force exerted by the kinesin and $F_{\text{fluid,component}}$ is the drag force exerted by the fluid in the cell. If the component is being dragged along at a constant velocity, what can you say about the magnitude of the two forces?

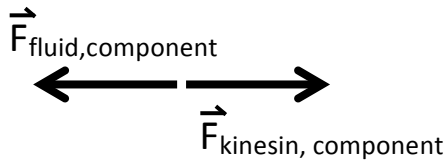

B) Suppose the component being dragged through the cell's fluid has a mass m and, when it is moving through the fluid with a speed v , experiences a drag force with magnitude equal to bv , where b is a constant. What is the magnitude of the force that the kinesin must exert on the component in order to move it along at constant velocity?

- a) $F_{\text{kinesin,component}} > bv$
- b) $F_{\text{kinesin,component}} = bv$
- c) $F_{\text{kinesin,component}} < bv$

C) How much work does the kinesin have to do in order to move the cargo a distance Δx along the tubule? Express your answer in terms of Δx and the symbols used in part a.

D) Using your result from b, create an expression for the rate at which work is done by the kinesin, $\Delta W/\Delta t$.

Work and Energy

Physics 103 – General Physics

- E) A kinesin that is transporting a secretory vesicle uses approximately 80 ATP molecules/s. Each ATP provides a kinesin molecule with an energy of about 0.8×10^{-19} J. If the velocity of the kinesin is 800 nm/s, can you determine the force the kinesin is exerting if you assume that all the ATP energy is used (100% efficiency)? If you can, find it. If not, explain why not.
- 7) Mary pulls a sled along a flat surface with her brother Jasper riding on the sled. The total mass of the sled and Jasper is 26 kg. The cord makes a 20.0° angle with the ground. The coefficient of kinetic friction between the sled and the ground can be approximated as $\mu_k = 0.16$. Find the work done on the sled by Mary and the work done by friction as the sled moves 120 m along a level path at a constant velocity of 3 km/s.

Potential Energy and Conservation – Group Sheet
 Physics 103 – General Physics

Your group member names:

1) Three balls of equal mass are fired simultaneously with equal speeds from the same height h above the ground. Ball 1 is fired straight up, ball 2 is fired straight down, and ball 3 is fired horizontally. Rank in order from largest to smallest the speeds of the balls, v_1 , v_2 , and v_3 , just before each ball hits the ground.

- a) $v_1 > v_2 > v_3$
- b) $v_3 > v_2 > v_1$
- c) $v_2 > v_3 > v_1$
- d) $v_1 = v_2 = v_3$

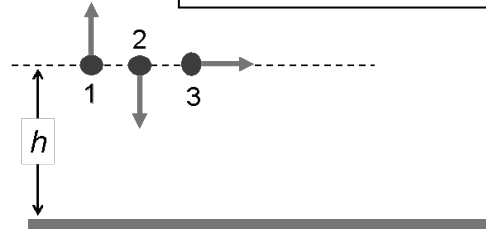

2) A box sliding on a horizontal frictionless surface runs into a fixed spring, compressing it a distance x_1 from its relaxed position while momentarily coming to rest. If the initial speed of the box were doubled, how far x_2 would the spring compress?

- a) $x_2 = \sqrt{2} x_1$
- b) $x_2 = 2 x_1$
- c) $x_2 = 4 x_1$

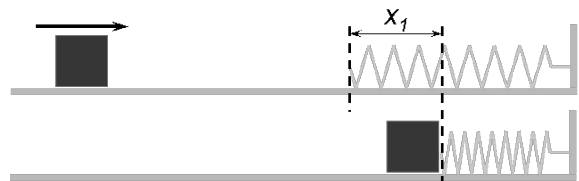

3) A cart with a spring on the end of it is moving to the right on a frictionless air track. It keeps going until it hits a wall. The spring compresses and the cart bounces off the wall and moves in the opposite direction. Choose all the graphs (there may be more than one) that could represent each of the following quantities as a function of time. (In each graph, the axes cross at the origin of the two coordinates.)

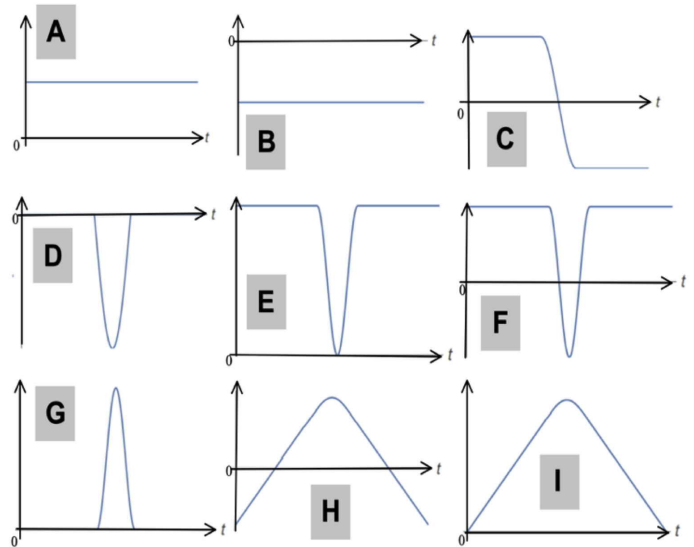

Position of the cart:

Velocity of the cart:

Kinetic energy of the cart:

Potential energy of the cart:

Total mechanical energy of the cart plus spring:

Potential Energy and Conservation
Physics 103 – General Physics

Useful Expressions:

$$K_{\text{trans}} = \frac{1}{2} mv^2$$

$$U_{\text{grav}} = mgh$$

$$U_{\text{spring}} = \frac{1}{2} kx^2$$

$$U_i + K_i + W_{\text{ext}} = U_f + K_f$$

$$\Delta E_{\text{mech}} = \Delta U + \Delta K = 0 \text{ if there are only}$$

conservative forces acting on a system

Reflect on the experience you've had so far with today's topic. What sorts of notes might you want to write on a note sheet for the exam (which you can test out by using for the rest of the worksheet and on this week's homework and quiz too)?

4) A spring with spring constant k is compressed a distance of x_i from its equilibrium position by a block with a mass m . The block is on a frictionless surface that leads to an incline that has a height y_H .

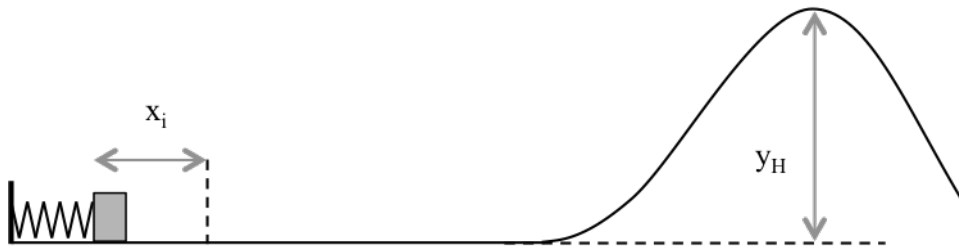

A) What is the initial energy of the block-earth-spring system before you let the block move? Enter the correct expressions in the boxes below:

K_i

U_i

Potential Energy and Conservation
 Physics 103 – General Physics

B) Imagine that you release the block and let it move freely. As the block moves along the surface, is any work external to the block-earth-spring system done on it? (Another way to ask this question would be, do any nonconservative forces do work on the block?)

C) You let the block go and it travels along the surface and up the rise some vertical height h (which is less than y_H) and comes to a stop. What is the final energy of the block-earth-spring system at this point?

K_f U_f

D) Use what you've found above to fill in the following boxes.

K_i U_i W_{ext} K_f U_f

++=+

E) If $k = 900 \text{ N/m}$, $m = 3 \text{ kg}$, and $x_i = 15 \text{ cm}$, how high does the block go up the incline?

5) A spring with spring constant k is compressed a distance of x_i from its equilibrium position by a block with a mass m . The block is on a frictionless surface that leads to an incline that has a height y_H . There is also a rough patch (where there is friction) of width Δx_f and coefficient μ_k on the surface as shown.

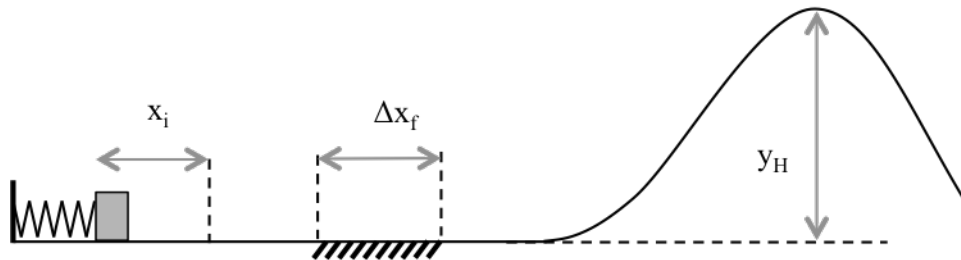

Potential Energy and Conservation
Physics 103 – General Physics

A) Suppose that $k = 900 \text{ N/m}$, $m = 3 \text{ kg}$, and $x_i = 15 \text{ cm}$, what would the velocity of the block be just after it leaves the spring but before it hits the rough patch?

B) If $\mu_k = 0.5$ and $\Delta x_f = 40 \text{ cm}$, how much work will the rough patch do on the block as the block moves over it? Is this work positive or negative?

C) You let the block go from the initial position shown in the drawing above (when it is compressing the spring) and it travels along the surface (including the rough patch) and up the incline some height h (which is less than y_H) and comes to a stop. Fill in the following boxes for the block's initial and final positions.

$$\begin{array}{ccccccccc} K_i & & U_i & & W_{\text{ext}} & & K_f & & U_f \\ \boxed{} & + & \boxed{} & + & \boxed{} & = & \boxed{} & + & \boxed{} \end{array}$$

D) Use your answer to C to find how high the block goes up the rise. If it is different from your answer to 4E, explain why.

E) If the block were heavier, would it go further up the rise or less far? Why?

Potential Energy and Conservation
Physics 103 – General Physics

6) A spring with spring constant k is compressed a distance of x_i from its equilibrium position by a block with a mass m . The block is on a frictionless surface that leads to a dip of depth y_L and an incline that has a height y_H . There is also a rough patch (where there is friction) of width Δx_f and with coefficient μ_k on the surface as shown.

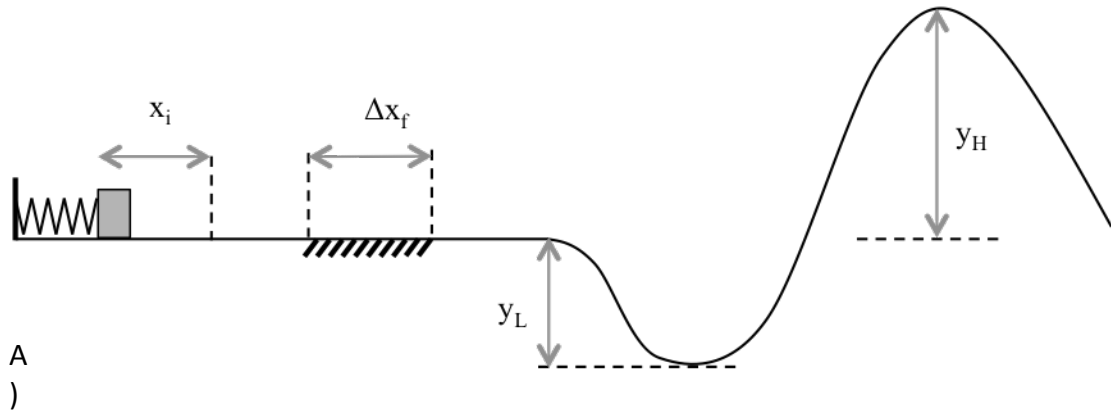

A
)

A) Suppose that $k = 900 \text{ N/m}$, $m = 3 \text{ kg}$, $x_i = 15 \text{ cm}$, $\Delta x_f = 40 \text{ cm}$, $\mu_k = 0.5$, and $y_L = 75 \text{ cm}$. You let the block go and it travels along the surface (including the rough spot) and into the dip. What is the speed of the block at the bottom of the dip?

B) How high up the incline does the block go?

C) Does the depth of the dip, y_L , affect how high the block goes up the incline? Why or why not?

D) If $y_H = 2 \text{ m}$, how much would you need to compress the spring in order to have the block just make it over the top of the incline?

Potential Energy and Conservation
Physics 103 – General Physics

7) A proposed energy storage system called ARES (Advanced energy rail storage) takes energy generated from renewable sources like solar or wind power and uses it to move rail cars carrying large blocks of concrete up a slope. Then, when the sun isn't shining or the wind isn't blowing, that energy can be reclaimed by letting the cars roll back down the hill and turn onboard electrical generators as it moves.



An early test of the system in Nevada will involve an 8.8 km track on an 8 degree slope. Currently, ARES is 86% efficient, which means 86% of the power used to move a rail car up the slope can be reclaimed when it comes back down.

A) Assuming each rail car has a net weight of 8.7 million kg, how much energy could one car store? You want to find the actual usable energy that could be reclaimed.

B) Usually, for purposes of power generation and consumption, it's more useful to talk in terms of power than energy. Assuming that you have regulators that ensure the energy per unit time generated by each car as it moves down the slope is constant, what power would a single car generate as it went down the 8.8 km track starting from rest? You can ignore any friction between the car and the track. (Hint: You need to know how long the car would need to get from the top of the track to the bottom.)

C) Can you think of any other potential energy storage systems using gravitational potential energy that could be scaled up to meet the needs of a large population of people?

Momentum – Group Sheet
 Physics 103 – General Physics

1) Sketch $\Delta \vec{p}$ (as a vector) in each case. (Hint: $\Delta \vec{p} = \vec{p}_f - \vec{p}_i$)

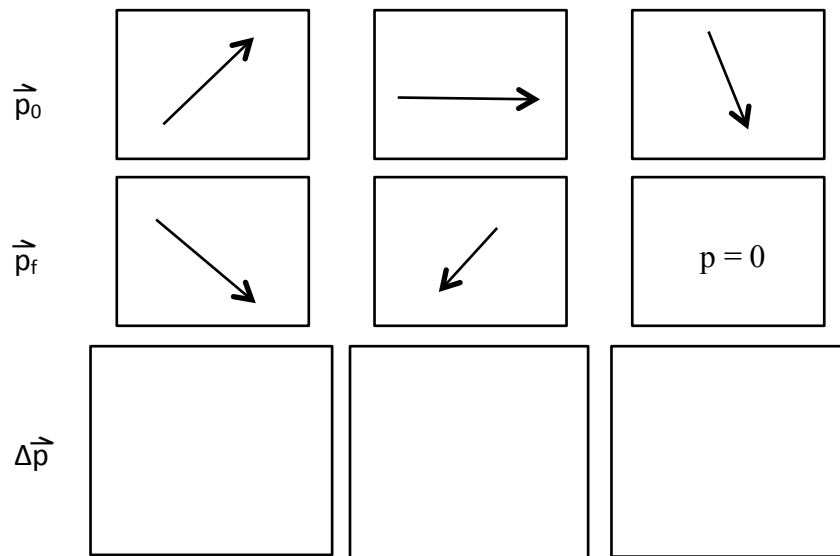

2) Two objects with masses m_1 and m_2 are approaching each other as shown. After they collide, m_1 reverses direction and moves left with a speed of $v/5$ and m_2 also reverses direction and moves to the right with a speed of $2v$. What can you say about the relationship between m_1 and m_2 .

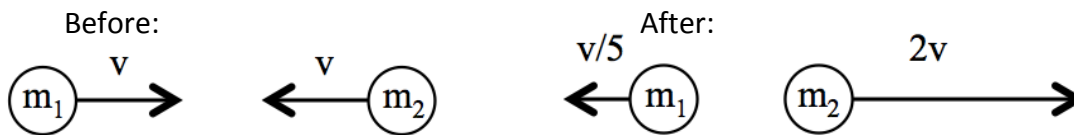

- a) $m_1 = 0.5m_2$
- b) $m_1 = m_2$
- c) $m_1 = 2.5m_2$
- d) $m_1 = 0.1m_2$
- e) $m_1 = 10m_2$

3) In almost every superhero movie ever made, there's one scene where someone falls off something tall and gets caught a fraction of a second before they hit the ground. Why is this not a good idea if you actually wanted to save the falling person?

Momentum

Physics 103 – General Physics

Useful Expressions:

$$\vec{F}\Delta t = \Delta\vec{p} \quad \vec{p} = m\vec{v}$$

$\vec{p}_f = \vec{p}_i$ (which is the same thing as $\Delta\vec{p} = 0$) if there are no net external force on a system

Reflect on the experience you've had so far with today's topic. What sorts of notes might you want to write on a note sheet for the exam (which you can test out by using for the rest of the worksheet and on this week's homework and quiz too)?

4) In zero-g conditions, astronauts' hearts can weaken over time because they don't have to work as hard as on Earth. You're responsible for interpreting a ballistocardiograph performed on one of the crew of the International Space Station. You'd like to ensure that the crewmember's heart is pumping at least 35 g of blood into the aorta.

The crewmember, whose mass is 54 kg, is observed floating in the middle of a cabin by a very precise motion sensor and you are able to determine that she moves 5×10^{-5} m in 0.16 s after each heartbeat. You also know from a previous Doppler ultrasound measurement that the speed of blood pumped into her aorta is 43 cm/s.

Is there any reason to worry about this crewmember's heart?

Momentum

Physics 103 – General Physics

5) Most of us know intuitively that in a head-on collision between a large dump truck (mass = M) and a subcompact car (mass = m), you are better off being in the truck than in the car. Why? Many people imagine that the collision force exerted on the car is much greater than that exerted on the truck. To substantiate this view, they point out that the car is crushed, whereas the truck is only dented. This idea of unequal forces, of course, is false; Newton's third law tells us that both objects are acted on by forces of the same magnitude. The truck suffers less damage because it has a stronger structure.

But what about the two drivers? Do they experience the same forces? This is what we want to find out.

A) Before you do any calculations, make a prediction. Do you think the two drivers will experience the same force during the collision?

B) Let's start by examining the situation before the collision. Draw a picture of the truck and car as they approach each other. Label their masses and assume their velocities have the same magnitude (call it v_0). Also indicate the orientation of your coordinate system.

C) Write an expression for the total momentum of the truck-car system before the collision.

D) Now let's focus on what happens after the collision. Here we'll be assuming that the front ends of the truck and car are smashed together so that the two are moving as one big object. Draw a picture here of the car and truck post-collision. Label their masses and their velocity (call it v_f).

Momentum

Physics 103 – General Physics

E) Write an expression for the total momentum of the car-truck system after the collision.

F) Use the following information to solve for v_f : The car and truck are initially moving at 6.7 m/s in opposite directions. The mass of the truck is 4000 kg and the mass of the car is 800 kg.

G) Since we have v_0 and v_f (magnitude and direction – remember, momentum is a vector) for each vehicle, compute Δp for the truck and Δp for the car.

	magnitude	direction
$\Delta p_{\text{truck}} =$	<input type="text"/>	<input type="text"/>
$\Delta p_{\text{car}} =$	<input type="text"/>	<input type="text"/>

H) Now, determine the change in the momentum of each driver. They will both experience the same change in velocity as their vehicles, but now they have equal masses of 71 kg.

	magnitude	direction
$\Delta p_{\text{truck driver}} =$	<input type="text"/>	<input type="text"/>
$\Delta p_{\text{car driver}} =$	<input type="text"/>	<input type="text"/>

I) Assume the collision takes a period of time equal to 0.05 seconds. Use the definition of impulse to determine the magnitude of the average force on each driver.

Momentum

Physics 103 – General Physics

J) Does your result above in part I match your initial prediction?

6) The above calculation assumed that neither driver was wearing a seatbelt. That means their momenta changed during the time of the collision only. But seatbelts and airbags can extend the time it takes to change a person's momentum in a crash.

A) Assume that the driver a car is wearing a seatbelt, which extends the time during which their momentum changes to 0.3 s. What is the average force they feel in this case?

B) Assume the car has an airbag, which extends the time during which their momentum changes to 1 s. What is the average force they feel in this case?

7) Let's try and think about the connection between impulse and kinetic energy. Two carts are acted on by the same force from the first mark to the second mark as shown on the following diagram.

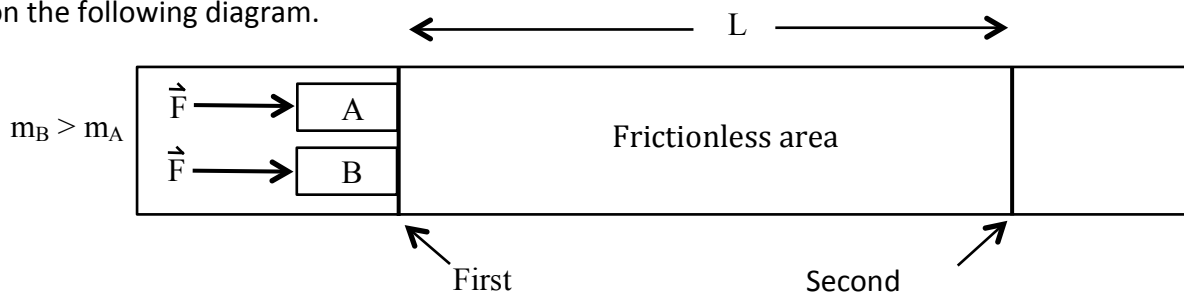

A) Which cart takes longer to travel from the first mark to the second mark? Explain your reasoning.

Momentum

Physics 103 – General Physics

B) When the two carts reach the second mark, which will have the most kinetic energy? Why?

C) Which cart receives the larger impulse?

D) Which cart arrives at the second mark with the larger momentum?

E) Suppose that $F = 20 \text{ N}$, $m_A = 10 \text{ kg}$, $m_B = 20 \text{ kg}$, and $L = 3 \text{ m}$. Calculate the initial and final kinetic energy for each cart. Do your results agree with your conclusions above?

Cart A		Cart B	
Initial K	Final K	Initial K	Final K
<input type="text"/>	<input type="text"/>	<input type="text"/>	<input type="text"/>

F) Calculate the magnitudes of the initial and final momentum for each cart. Do your results agree with your conclusions above?

Cart A		Cart B	
Initial p	Final p	Initial p	Final p
<input type="text"/>	<input type="text"/>	<input type="text"/>	<input type="text"/>

Your group member names:

Rotation, Torque, and Energy – Group Sheet
Physics 103 – General Physics

1) Madison is roughly at the 45th parallel in the northern hemisphere. As you sit in your seat, are you moving with more, less, or the same angular velocity as someone sitting down to do physics at the equator? Only consider the rotation of the Earth on its axis here.

- a) Your angular velocity is larger than that of the person at the equator.
- b) Your angular velocity is less than that of the person at the equator.
- c) Your angular velocity is the same as that of a person at the equator.
- d) You can't tell without knowing height above sea level

2) A solid sphere and hollow sphere of the same mass and radius are rolling along the floor without slipping at the same linear velocity. Which has the greater rotational kinetic energy? (You can find formulae for the moments of inertia of solid and hollow spheres on the next page.)

- a) The solid sphere
- b) The hollow sphere
- c) They both have the same kinetic energy.
- d) We can't say without knowing their angular velocities.

3) You have a choice of two different wheels for your bike. The first have a moment of inertia of 0.01 kg m^2 . The second have a moment of inertia of 0.02 kg m^2 . If you coast down from the top of a large hill, which will give you the largest speed at the bottom? Assume everything else about the wheels (like internal friction) is the same.

- a) The first wheels
- b) The second wheels
- c) You'll be going the same speed no matter which wheels you use.
- d) We can't say without knowing the mass of the wheels.
- e) We can't say without knowing the radius of the wheels.

Rotation, Torque, and Energy
Physics 103 – General Physics

Useful Expressions:

$$v = r\omega \text{ (true for any point on a rotating object)}$$

$$K_{\text{rot}} = (1/2)I\omega^2$$

$$v_{\text{CM}} = R\omega \text{ (true for an object of radius } R \text{ rolling without slipping)}$$

Reflect on the experience you've had so far with today's topic. What sorts of notes might you want to write on a note sheet for the exam (which you can test out by using for the rest of the worksheet and on this week's homework and quiz too)?

Moment of Inertia for Solid Objects

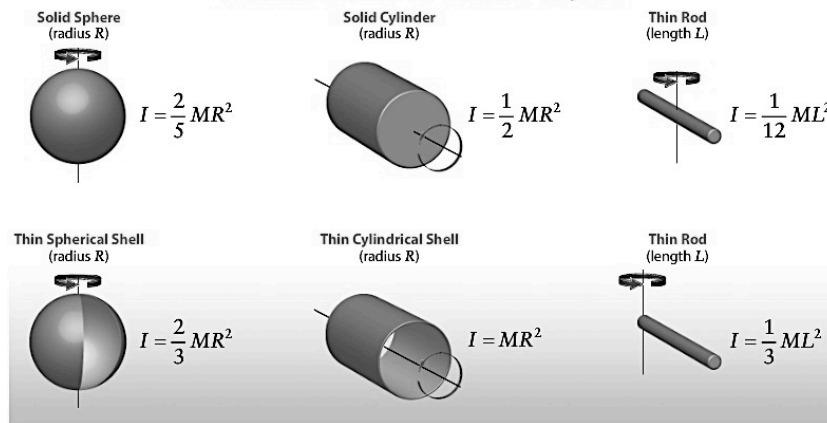

4) When we talk about rotation, we'll be using a unit called a radian instead of a degree. A full circle is 2π radians.

A) Calculate how many degrees there are in each radian.

B) Sketch the angle represented by one radian on the following circle.

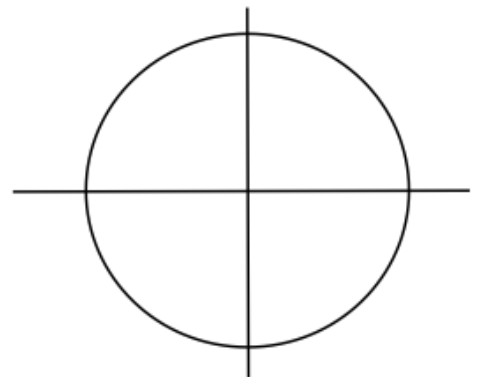

C) If the circle turns 17 degrees in one second, how many radians has it turned in one second?

Rotation, Torque, and Energy
Physics 103 – General Physics

5) One proposal to either augment or compete with electric hybrid cars is to use a flywheel to temporarily store energy rather than a battery, sometimes called a Kinetic Energy Recovery System (KERS) or a “flybrid.”

FLYWHEEL KERS

FLYWHEEL MODULE

Flywheel in vacuum
Carbon fibre rim
on a steel hub

Flywheel containment

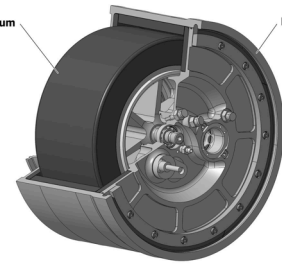

A) Imagine a flywheel that had a mass of 6 kg and a radius of 10 cm. If the disk is spinning at 60,000 rpm (revolutions per minute), what is its angular velocity in radians per second?

B) Let's start by supposing that the flywheel is a solid disk (use I for a solid cylinder). In this case, how much kinetic energy will it store at 60,000 rpm?

C) If the flywheel is a hoop (use I for a cylindrical shell), how much kinetic energy will it store at 60,000 rpm?

D) If the flywheel is a solid sphere, how much kinetic energy will it store at 60,000 rpm?

E) Which shape should you choose if you want a flywheel that stores the most rotational kinetic energy?

Rotation, Torque, and Energy
Physics 103 – General Physics

6) Let's imagine you are kicking a soccer ball. We want to find how fast your shoe (at the end of your leg) is moving when it strikes the ball. In order to do this, we're going to model your leg as a thin rod of length L being rotated around one end. We'll assume your leg starts from rest at an angle, then drops to meet the ball.

When we consider the gravitational potential energy of an extended object, we always measure height from the object's center of mass. The gray dot in the diagram to the right represents your leg's center of mass (which we'll assume is right in the center of your leg). As you swing your leg, its center of mass drops a distance of Δy .

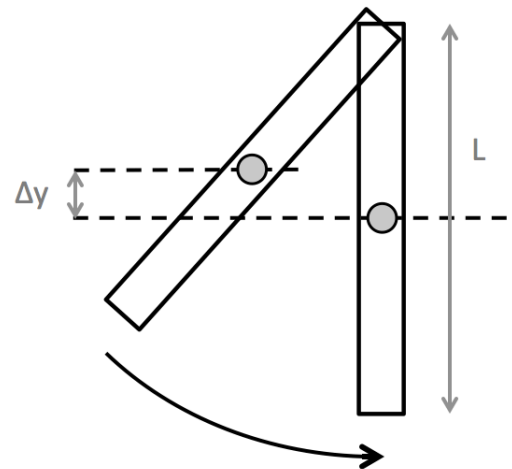

- A) Write an expression for the initial potential energy of your leg (which we mean as shorthand for the system composed of the Earth and your leg). Remember to include all the forms of potential energy you know about.
- B) Write an expression for the initial kinetic energy of your leg. Again, remember to include all the forms of kinetic energy you know about.
- C) Write an expression for the final potential energy of your leg.
- D) Write an expression for the final kinetic energy of your leg.

Rotation, Torque, and Energy
Physics 103 – General Physics

E) Assume that, as you swing your leg, you (i.e., an external force) do 186 J of work to speed your leg up. If $m = 12$ kg, $\Delta y = 12$ cm, and $L = 0.8$ m, how fast is your foot moving when it hits the soccer ball?

7) In the Fliplt bridge set for this week, you were asked about which shape shown to the right would make it furthest up an inclined plane rolling without slipping if you started them all off with the same linear velocity. Let's check to see how far each would actually get. Assume that each begins with a linear velocity of 6 m/s toward the base of the plane.



hoop



solid disk



solid sphere

A) Notice we haven't given you the angle of the inclined plane. Does it matter for the question we're answering? Can you think of a question we could ask that would require you knowing what the angle of the plane was (other than "what's the angle of the plane")?

B) Based on your work in problem 5 above and before we do any calculations here, which do you think will make it furthest up the plane? Why?

Rotation, Torque, and Energy
Physics 103 – General Physics

C) Calculate the linear and rotational kinetic energy of each shape, then determine the total kinetic energy in each case. (Since you don't yet know the mass, just leave it as a variable. You'll see why shortly.)

	Hoop	Disc	Sphere
K_{lin}	<input type="text"/>	<input type="text"/>	<input type="text"/>
K_{rot}	<input type="text"/>	<input type="text"/>	<input type="text"/>
K_{total}	<input type="text"/>	<input type="text"/>	<input type="text"/>

D) A quick aside: Which shape required the most work to accelerate up to 6 m/s? (Remember that positive work done on a system increases the kinetic energy of the system.)

E) Use your calculations from C to find the vertical height each shape rises to on the inclined plane.

F) Was your prediction in B correct? Why or why not?

Rotation, Torque, and Energy
Physics 103 – General Physics

8) Let's revisit an old friend – pulleys! Prior to now, we've always specified that we were using massless pulleys. That may have seemed like a detail, but it turns out to be quite an important stipulation. Let's see why.

A) Imagine you have an object (mass = M) connected to a rope wound around a pulley. We'll start with a pulley without mass shaped like a solid disc. You let the object go and it falls a distance Δy . What is its speed at the end of its fall?

B) Now suppose the pulley has some mass, m , and radius, r , and is shaped like a solid disk. In this case, what is the speed of the object after it falls a distance Δy ?

C) Which speed is smaller, the one you found in A or the one you found in B? Why? Can you explain?

D) What happens if you double the radius of the pulley? Will that affect your answer in B?

E) Based on your experience in previous questions, if you wanted to ensure that the object was moving with the least speed after falling a distance of Δy (for instance, as a safety measure in designing the pulley at the top of an elevator shaft) would you choose a pulley shaped like a solid disk or one shaped like a hoop? Assume they have the same mass. Also be sure to justify your answer.

Rotational Kinematics and Dynamics – Group Sheet
 Physics 103 – General Physics

Your group member names:

1) An ice skater is spinning with her arms extended at 1 rev/s. She pulls in her arms and spins at 5 rev/s. What is the ratio of her initial moment of inertia to her final moment of inertia, $I_{\text{initial}}:I_{\text{final}}$?

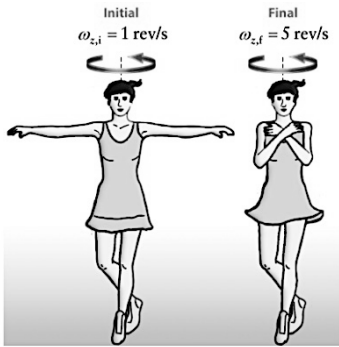

- a) 5:1
- b) 1:5
- c) 1:1

2) Consider the forces on an object, as shown. The axis of rotation of the object is marked with the \otimes . The object is oriented at a 45° angle with respect to the horizontal. If all the forces have the same magnitude, rate the torques associated with each from smallest to largest.

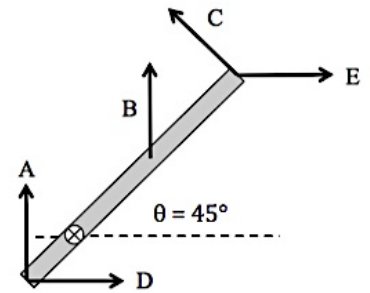

- a) $\tau_A = \tau_D < \tau_B < \tau_E = \tau_C$
- b) $\tau_B < \tau_A = \tau_C < \tau_E = \tau_D$
- c) $\tau_A = \tau_B < \tau_D = \tau_E < \tau_C$
- d) $\tau_A = \tau_D < \tau_B < \tau_E < \tau_C$
- e) $\tau_D < \tau_A < \tau_B < \tau_E < \tau_C$

3) In the same picture, circle the correct direction of the torque exerted by each force.

- A Clockwise Counterclockwise
- B Clockwise Counterclockwise
- C Clockwise Counterclockwise
- D Clockwise Counterclockwise
- E Clockwise Counterclockwise

4) A ladder is propped up against a wall. There is static friction between the base of the ladder and the floor and between the top of the ladder and the wall. A person is on the ladder, 3/4 of the way up from the base. Draw an extended free body diagram of the ladder that includes the following forces:

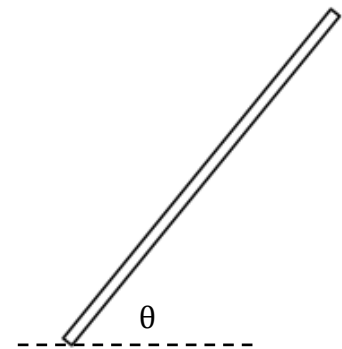

- $F_{F,L}$ – the normal force by the floor on the ladder
- $f_{F,L}$ – the static frictional force by the floor on the ladder
- $F_{W,L}$ – the normal force by the wall on the ladder
- $f_{W,L}$ – the static frictional force by the wall on the ladder
- $W_{E,L}$ – the gravitational force by the Earth on the ladder
- $F_{P,L}$ – the force by the person on the ladder

Rotational Kinematics and Dynamics
Physics 103 – General Physics

Useful Expressions:

$$L = I\omega \quad \tau = Fr\sin\theta = Fr_{\text{lever}} \quad (\text{Here, } \theta \text{ is the angle between } F \text{ and } r \text{ as vectors})$$

$$\text{Equilibrium} \Rightarrow \Sigma \vec{F}_{\text{ext}} = 0 \text{ \underline{and} } \Sigma \tau = 0$$

Gravity always acts on the center of mass of an object.

Reflect on the experience you've had so far with today's topic. What sorts of notes might you want to write on a note sheet for the exam (which you can test out by using for the rest of the worksheet and on this week's homework and quiz too)?

5) Three forces are acting on an object as shown. The object is in equilibrium and not moving. The magnitude of $F_{1,\text{object}}$ is 10 N. We want to be able to specify $F_{2,\text{object}}$ and $F_{3,\text{object}}$.

A) We said that the object was in equilibrium *and* not moving. Are these the same or different? Can an object be in equilibrium and moving? If so, what kind of motion can it have?

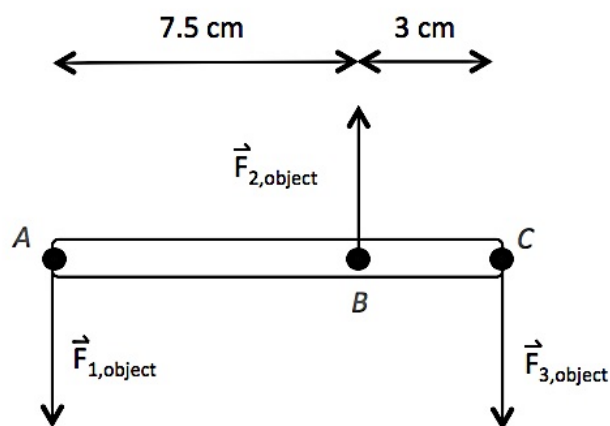

B) Write down the sum of the forces on the object below.

$$\boxed{\phantom{\sum \vec{F} = 0}} = 0$$

C) Now write down the sum of the torques assuming that A is the axis of rotation of the object. Does the result help you solve for $F_{2,\text{object}}$ and $F_{3,\text{object}}$? If so, determine the magnitudes of both forces.

D) Write down the sum of the torques assuming that B is the axis of rotation of the object. Does the result help you solve for $F_{2,\text{object}}$ and $F_{3,\text{object}}$? If so, determine the magnitudes of both forces.

E) Write down the sum of the torques assuming that C is the axis of rotation of the object. Does the result help you solve for $F_{2,\text{object}}$ and $F_{3,\text{object}}$? If so, determine the magnitudes of both forces.

6) Now we're going to modify our object. We tilt the segment from B to C upward until it makes an angle of θ with respect to the horizontal. We also stretch the segment out so the distance from B to C becomes 5 cm. The horizontal distance from B to C remains 3 cm. $F_{1,\text{object}}$ remains 10 N. Once again, we do not know the magnitudes of $F_{2,\text{object}}$ and $F_{3,\text{object}}$.

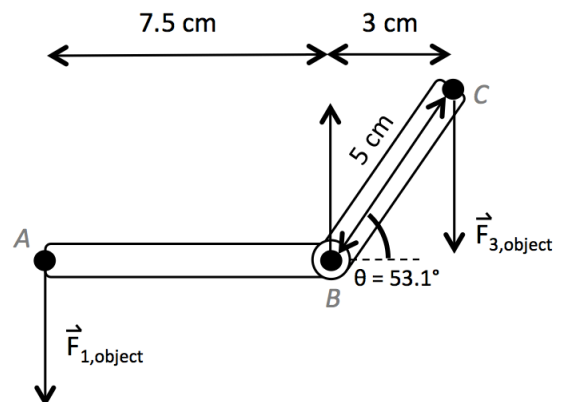

Rotational Kinematics and Dynamics
Physics 103 – General Physics

A) Make a prediction: Will $F_{3,\text{object}}$ be the same as it was in the previous problem?

B) If you sum up the forces on the object, will you get a different result than you wrote down in 5B above? If so, write it here.

C) Suppose we want to determine the magnitude of $F_{3,\text{object}}$. Which point (A, B, or C) should we choose as the object's axis of rotation?

D) Using the point you identified as the axis of rotation in C, find $F_{3,\text{object}}$.

E) Was your prediction in A correct or not?

F) The distance between an axis of rotation and the line along which a force is acting measured perpendicularly to the direction of the force is called a lever arm, r_{lever} . If B is the axis of rotation, what is the lever arm for the $F_{3,\text{object}}$?

7) The masseter muscle plays a large role in chewing and biting.

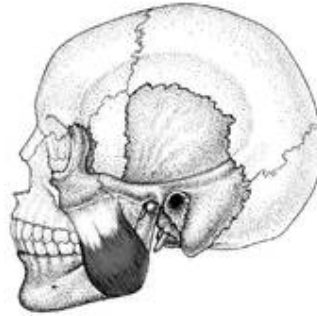

We want to find the force that a person can bite down with by exerting their masseter. First, let's model the mandible (or jawbone) in a way that allows us to do calculations with it. To a pretty good degree of approximation, we can treat the mandible as if it were a bent bar, like so:

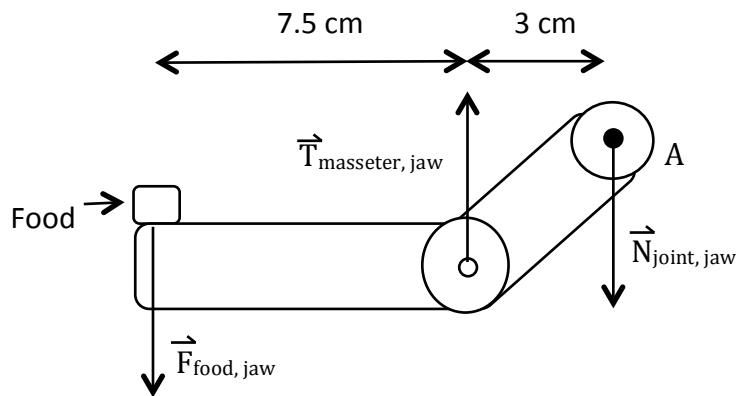

A is the joint and the axis about which the mandible moves. $N_{\text{joint,jaw}}$ is the force that the skull exerts on the mandible at the joint. $T_{\text{masseter,jaw}}$ is the tension in the masseter pulling the jaw up. And $F_{\text{food,jaw}}$ is the force that a piece of food located at the incisors exerts down on the jaw. The distances given are more or less typical.

A) Suppose that the only thing we know about the jaw is that $N_{\text{joint,jaw}}$, the force at the jaw's joint is 1250 N. You then have two equations and two unknowns. You can find values for both $T_{\text{masseter,jaw}}$ and $F_{\text{food,jaw}}$.

$T_{\text{masseter,jaw}}$ is: _____

$F_{\text{food,jaw}}$ is: _____

B) Using the fact that 1 N is equal to 0.225 pounds of force, find F in pounds.

$F_{\text{foos,jaw}}$ in pounds is: _____

C) In order for an animal to be able to exert more force on an object with its jaw, how would you need to change the jaw's structure to make this possible?

8) Let's return to the ladder you analyzed in question 4. To simplify things, we can imagine that the ladder is up against a very smooth wall so that there is no frictional force exerted on the ladder by the wall. Suppose we further know the mass of the ladder (M), the person's mass (m), and the angle between the ladder and the floor (θ). Can you find the frictional force between the ladder and the floor?

You can – by putting everything you know about forces and free body diagrams to work. Rather than actually solve anything here, we'll just sketch how you would set a solution up. That can be the hardest part of approaching a problem, as many of you likely know.

A) First add up the forces (not torques) in the x and y directions and determine what they must equal. You can choose which axis is which.

B) Use the expressions above, and your knowns and unknowns, to determine where you should place the axis of rotation on the ladder in order to use the two force equations and the sum of torques in order to find the force of friction between the ladder and the floor.

Oscillations – Group Sheet
Physics 103 – General Physics

1) Circle the correct words in the following statements:

To increase the frequency of a mass/spring system, use a stronger / weaker spring.

To increase the frequency of a mass/spring system, use a lighter / heavier mass.

To decrease the frequency of a mass/spring system, use a stronger / weaker spring.

To decrease the frequency of a mass/spring system, use a lighter / heavier mass.

2) A duck is bobbing up and down on Lake Monona. You can model this by imagining the duck is oscillating at the end of a spring. If we graph the duck's position over time we get a plot like the one below. (Note: This is a sine curve.) Which statement describes the duck's motion at point P?

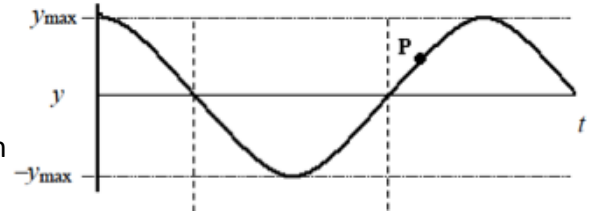

- a) Positive velocity and positive acceleration
- b) Positive velocity and negative acceleration
- c) Positive velocity and zero acceleration
- a) Negative velocity and positive acceleration
- b) Negative velocity and negative acceleration
- c) Negative velocity and zero acceleration
- a) Zero velocity and positive acceleration
- b) Zero velocity and negative acceleration
- c) Zero velocity and zero acceleration

3) You'd like to increase the period of a simple pendulum by a factor of 3. What can you do? Select all that apply.

- a. Increase the length of the string by 3 times.
- b. Increase the mass of the object on the string by $\sqrt{3}$ times.
- c. Increase the initial angle of deflection by 3 times.
- d. Increase the length of the string by 9 times.
- e. Decrease the mass of the object on the string by 3 times.

4) Name one instance when someone in your group experienced the phenomenon of resonance and describe it here. Be sure to check in with your TA to make sure this was an actual case of resonance.

Oscillations
Physics 103 – General Physics

Useful Expressions:

$$F_{\text{spring}} = -k\Delta x \quad U_{\text{spring}} = \frac{1}{2} kx^2 \quad E_{\text{tot}} = \frac{1}{2} kx^2 + \frac{1}{2} mv^2$$

$$\omega_0 = \sqrt{\frac{k}{m}} \quad f = \frac{1}{2\pi} \sqrt{\frac{k}{m}} \quad T = 2\pi \sqrt{\frac{m}{k}} = 1/f \quad \text{for a spring-mass system}$$

$$\omega_0 = \sqrt{\frac{g}{L}} \quad f = \frac{1}{2\pi} \sqrt{\frac{g}{L}} \quad T = 2\pi \sqrt{\frac{L}{g}} = 1/f \quad \text{for a pendulum}$$

$$x = A\cos(\omega_0 t) \quad v = -\omega_0 A\sin(\omega_0 t) \quad a = -\omega_0^2 A\cos(\omega_0 t) \quad \text{if } x = A \text{ at } t = 0$$

$$A(\omega) = \frac{F_0}{\sqrt{m^2(\omega_0^2 - \omega^2)^2 + b^2\omega^2}} \quad \text{for an oscillator driven with force } F_0$$

Reflect on the experience you've had so far with today's topic. What sorts of notes might you want to write on a note sheet for the exam (which you can test out by using for the rest of the worksheet and on this week's homework and quiz too)?

5) You have a 4 kg mass on the end of a spring with a spring constant $k = 2500 \text{ N/m}$. The mass is in its equilibrium position. Suppose you then compress the spring by 3 cm and give it a kick so that it has an initial velocity toward the base of the spring equal to 250 cm/s. What is the amplitude of the resulting oscillation?

A) We'll take this one step at a time. What is the kinetic energy of the mass just after you kick it? Assume the mass hasn't yet moved.

Oscillations
Physics 103 – General Physics

B) What is the potential energy of the mass/spring at this same moment?

C) So what is the total mechanical energy of the system?

D) Now imagine that the mass has moved a distance from the equilibrium point equal to the amplitude of the oscillation. What is the potential energy of the mass/spring system at this moment?

E) What is the kinetic energy after the mass has moved a distance from the equilibrium point equal to the amplitude of the oscillation?

F) Use parts D and E to find the amplitude of the oscillation.

G) What is the maximum velocity of the mass at the end of the spring as it passes back through the equilibrium point?

Oscillations

Physics 103 – General Physics

- H) What is the velocity of the mass when it is one half the distance between the equilibrium point and the turnaround point when $x = A$?
- 6) Suppose you start with a simple pendulum: a 500 g mass on the end of 80 cm-long string.
- A) What is the period of this pendulum?
- B) What is the frequency of the pendulum?
- C) What could you change about the pendulum and not affect the frequency?
- D) The acceleration due to gravity on the surface of the moon is 1.6 m/s^2 . Would the frequency of the pendulum increase, decrease, or remain the same if it were transported to the moon?
- E) What is the ratio of the pendulum's frequency on the moon to its frequency on the Earth?

Oscillations

Physics 103 – General Physics

- F) What would the frequency of the pendulum be if you put it on the International Space Station in zero-g conditions?
- G) Like all oscillators, the pendulum has some total amount of mechanical energy. What could you change that would increase this energy? (Hint: Think about the things that affect the total mechanical energy of a mass-spring system and find the analogues to those things with a pendulum. What determined the kinetic energy of the pendulum? What is the potential energy due to and what affects it?)
- 7) The sine and cosine equations for x , v , and a contain much more information about an oscillating mass/spring system than you might think. To see that, imagine the following: You have a mass/spring system with $m = 6 \text{ kg}$ and $k = 2100 \text{ N/m}$. You set up an oscillation that has an amplitude of $A = 20 \text{ cm}$. Assume that the block is at a position of $+A$ at $t = 0$.
- A) What is the position of the mass after 2.5 s ? (Remember to use the correct angular units on your calculator when finding the cosine here.)
- B) What is the velocity of the mass after 2.5 s ?
- C) What is the acceleration of the mass after 2.5 s ?

Oscillations
Physics 103 – General Physics

D) Think about your answers to A, B, and C and draw a picture of the mass below at $t = 2.5$ s. (Assume + means toward the right. The dashed line is the equilibrium position.) Indicate the position of the mass and draw the velocity and acceleration vectors.



E) Sum up your picture by choosing the right words in the statements below:

The mass is to the right / left of the equilibrium position.

The mass is moving toward / away from the equilibrium position.

The mass is speeding up / slowing down.

F) How many full oscillations has the mass made after 2.5 s? (Hint: To answer this question, think about the point moving on a circle that represents the oscillating mass. That point has a angular velocity of ω . Through what total angle will it rotate in 2.5 s? What angle represents one full oscillation of the mass?)

Oscillations

Physics 103 – General Physics

8) We don't always see how the various different equations that we use in this class are variations on the same basic principles. Let's try to make that visible here.

We know that the expression for the total mechanical energy in a mass/spring system is:

$$E_{\text{total}} = \frac{1}{2} kx^2 + \frac{1}{2} mv^2$$

We also know that the displacement from the equilibrium position and the velocity of a simple harmonic oscillator are given by:

$$x = A\cos(\omega t)$$

$$v = -A\omega\sin(\omega t)$$

where $\omega = 2\pi f$.

Using these three expressions, show that the total mechanical energy of an oscillating mass/spring system is equal to $\frac{1}{2} kA^2$. You'll also need to know that for any given θ , $\sin^2\theta + \cos^2\theta = 1$.

Wave Properties – Group Sheet
Physics 103 – General Physics

Your group member names:

1) A wave moves from one medium to another. In the second medium, it has half the wavelength and twice the frequency. What can you say about the second medium compared to the first?

- a) This is not a realistic situation – the wavelength of a wave never changes between media.
- b) The velocity of propagation is smaller in the second medium than in the first.
- c) The velocity of propagation is the same in both media.
- d) This is not a realistic situation – the frequency of a wave never changes between media.
- e) The velocity of propagation is larger in the second medium than in the first.

2) A boat is moored in a fixed location and waves make it move up and down. If the spacing between wave crests is L and the speed of the waves is v , how much time Δt does it take the boat to go from the top of one wave to the top of the next?

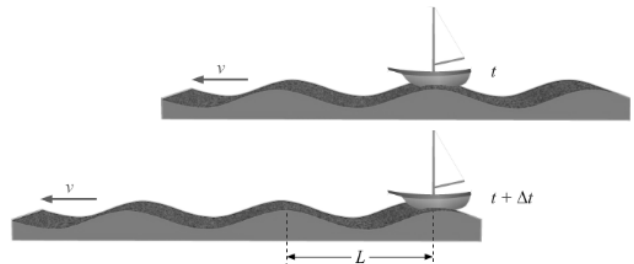

- a) $\Delta t = L/v$
- b) $\Delta t = Lv$
- c) $\Delta t = v/L$

3) Waves A and B are shown propagating in the same medium. How do their frequencies compare?

- a) $f_A > f_B$
- b) $f_A < f_B$
- c) $f_A = f_B$



4) You are wiggling the end of a string and sending waves down it at a certain velocity. You loosen your grip on the string and notice that the waves travel at half the velocity. What happened to the tension in the string?

- a) It increased by a factor of 2.
- b) It increased by a factor of 4.
- c) It decreased by a factor of 2.
- d) It decreased by a factor of $\sqrt{2}$
- e) It decreased by a factor of 4

Useful Expressions:

$$f = 1/T \quad v_{\text{propagation}} = f\lambda \quad v_{\text{transverse,string}} = \sqrt{\frac{F_{\text{tension}}}{\mu}}$$
$$\text{velocity of propagation} = \sqrt{\frac{\text{How tightly connected pieces of the medium are}}{\text{How much stuff is packed into the medium}}}$$
$$k = 2\pi/\lambda \quad \omega = 2\pi f \quad y(x,t) = A\cos(kx - \omega t + \phi)$$

Reflect on the experience you've had so far with today's topic. What sorts of notes might you want to write on a note sheet for the exam (which you can test out by using for the rest of the worksheet and on this week's homework and quiz too)?

5) Ultrasound can be used to image structures inside the body, by sending in high frequency sound waves. When these waves hit a change in medium (for instance, a boundary between one kind of tissue and another), some of them are reflected back and can be detected.

A) The speed of sound varies in different kinds of tissues. In muscle tissue, the speed of sound is typically 1580 m/s. If your ultrasound waves have a frequency of 4 Mhz (or 4 million Hz), what is their wavelength in muscle?

B) The speed of sound in bone is 3500 m/s. Why might it be so much higher than in muscle?

Wave Properties
Physics 103 – General Physics

C) In general, the wavelength of the ultrasound used to image tissues gives the limit of your resolution – that is, you can't see anything smaller than the wavelength of the ultrasound. If you wanted the same resolution in bone as you found in muscle in A, what frequency would you need to use?

6) Below are a y -vs- x and a y -vs- t graph for a wave passing through some medium.

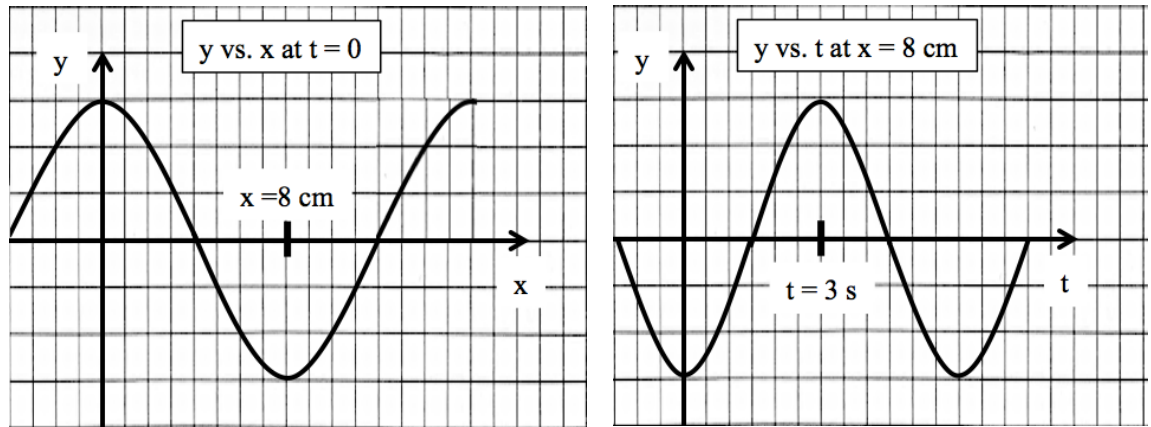

For the first graph, assume each square is 1 cm high and 1 cm wide. For the second graph, assume each square is 1 cm high and 0.5 s wide.

A) What is the wavelength of this wave?

B) What is the amplitude of this wave?

C) What is the period of the wave?

Wave Properties
Physics 103 – General Physics

D) What is the frequency of the wave?

E) What is the propagation velocity of the wave?

F) Sketch a snapshot of the wave after 3 seconds have elapsed.

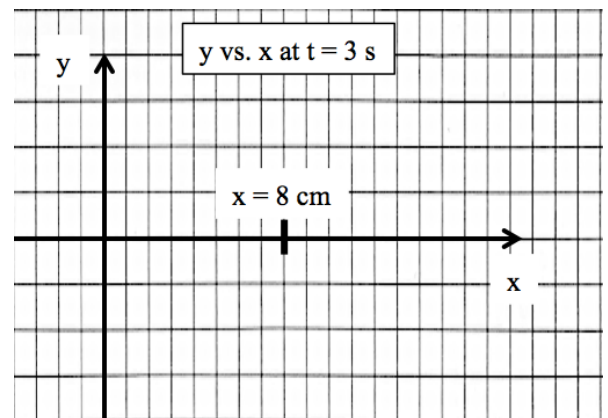

G) Suppose the wave enters a new medium where its velocity of propagation is cut in half. Indicate how each of its attributes will change and if so how?

Frequency:

Wavelength:

Wave Properties
Physics 103 – General Physics

H) Sketch the y-vs-x and y-vs-t graphs for the wave in the new medium. You can assume that the amplitude of the wave is still 3 cm at $x = 8$ cm like on the previous page.

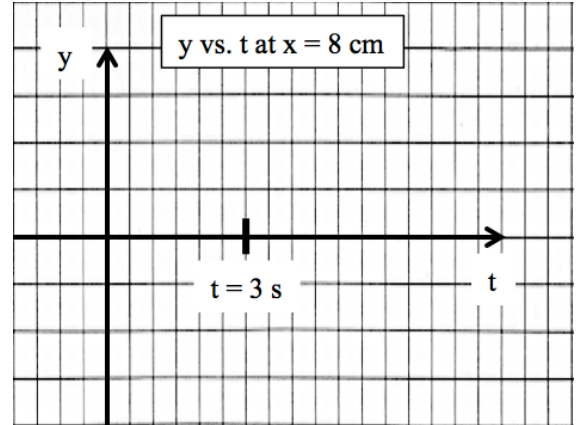
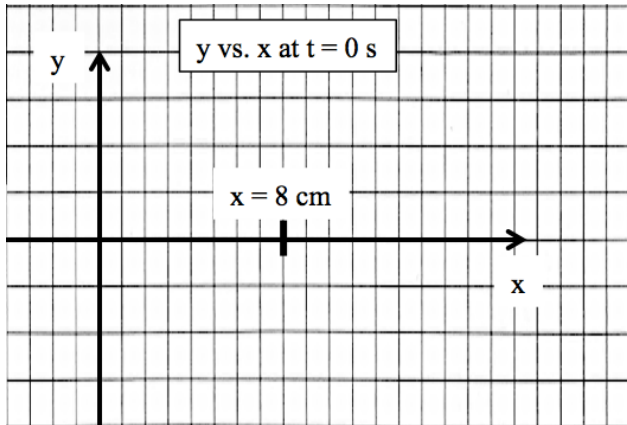

7) A transverse harmonic wave travels on a rope according to the following expression:

$$y(x,t) = (1.2)\cos(\pi x - (3\pi/2)t)$$

The mass density of the rope is $\mu = 0.123$ kg/m. x and y are measured in meters and t in seconds.

A) What is the amplitude of the wave?

B) What is the period of oscillation of the wave?

C) What is the wavelength of the wave?

Wave Properties
 Physics 103 – General Physics

D) Make a sketch of what this wave would look like if we could take a “snapshot” of it at time $t = 0$. That is, make a plot of $y(x,0)$ on a y -vs- x graph:

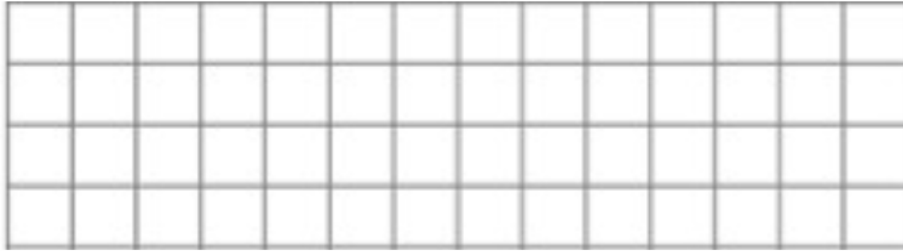

E) Make a sketch of the motion of a point at $x = 0$ m as a function of time. That is, make a “history” plot of $y(0,t)$ on a y -vs- t graph:

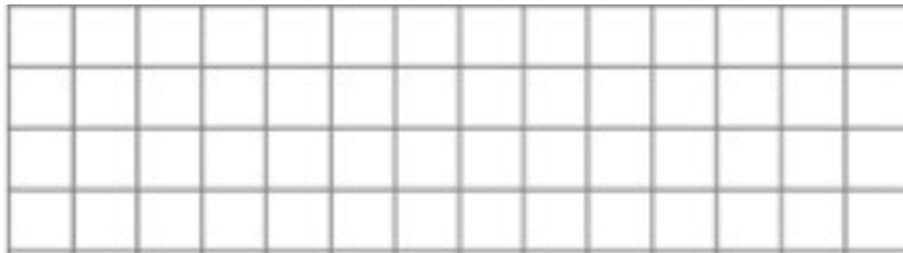

F) What is the speed of the wave?

G) What is the tension in the rope?

8) A pulse travels on a string. Its shape does not change. The displacement of the string as a function of time is shown in the figures below at two positions, $x = 0$ m and $x = 2$ m. These figures show that the string rises slowly to a height of 3 mm, remains at that height for some time, and lowers quickly back to the equilibrium position.

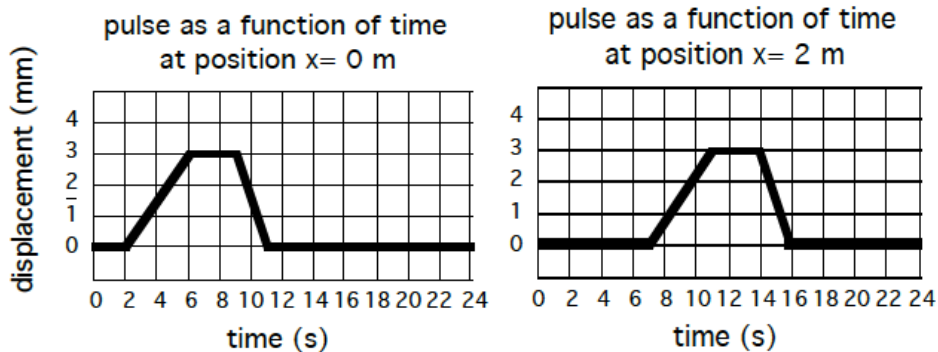

Wave Properties
Physics 103 – General Physics

A) How fast is the pulse traveling along the string?

B) Another view of the pulse is shown in the figure below, the displacement of the string at $t = 0$ s. What is the distance between points A and B?

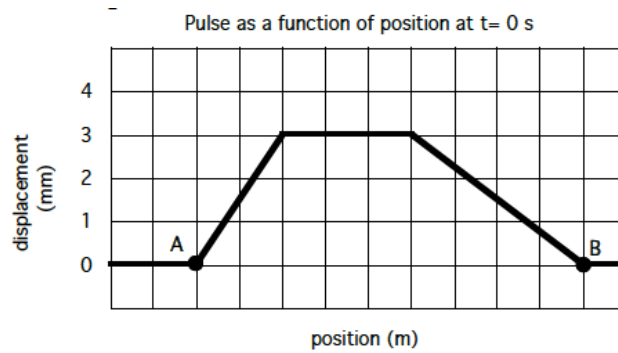

Wave Interference – Group Sheet
Physics 103 – General Physics

Your group member names:

1) Which analogy best describes the concept of superposition?

- a) You and I each have \$10. We both invest in the same opportunity and a little while later combine our earnings so that we have a total of \$30.
- b) We have 10 cookies between us. We each eat 5 so that there are no cookies left.
- c) I have 7 stones and you have 5 stones. I stack mine on at a particular spot on a beach. You walk by and stack yours on top of the ones I piled up.
- d) I type a paragraph and give it to you to revise. You remove one sentence and add another.

2) Two speakers are playing a tone of 340 Hz. The sound emitted is in phase (no phase difference) when it leaves each speaker. You are standing 2 m from one speaker and 2.5 m from the other. Do you hear the tone? Assume the speed of sound is 340 m/s.

- a) Yes, it would be very loud.
- b) No, there would be no tone.
- c) The tone would come and go.
- d) It depends on the distance between the speakers.

3) You observe that the sound produced by a musical instrument has a fundamental frequency of 440 Hz and higher harmonics at 880 Hz, 1320 Hz, and 1760 Hz (but nothing in between). What kind of musical instrument is it? Select all that apply.

- a) A string instrument
- b) A wind instrument (acting like a pipe closed at one end)
- c) A wind instrument (acting like a pipe open at both ends)
- c) It is impossible to tell with the information given.

4) You are tuning a piano by playing each key and then sounding a pure tone of the frequency the key is supposed to play. If the key is out of tune, you will hear beats. As you tune the string so that it gets closer to the correct frequency, will you hear the beats getting faster or slowing down?

- a) Getting faster
- b) Slowing down
- c) It depends on whether the string is sharp (at too high a frequency) or flat (too low a frequency).

Wave Interference
Physics 103 – General Physics

Useful Expressions:

Constructive Interference

$$\Delta\text{phase} = 0^\circ \text{ or } n(360^\circ)$$

$$\Delta\text{path} = n\lambda$$

Standing Waves (string)

$$\lambda_n = \frac{2L}{n}$$

$$f_n = \frac{n}{2L} \sqrt{\frac{F_{\text{tension}}}{\mu}}$$

$$n = 1, 2, 3, \dots$$

Beats: $f_{\text{beats}} = |f_2 - f_1|$

Destructive Interference

$$\Delta\text{phase} = 180^\circ \text{ or } (n+1/2)(360^\circ) \quad n = 0, 1, 2, \dots$$

$$\Delta\text{path} = (n+1/2)\lambda \quad n = 0, 1, 2, \dots$$

Standing wave (pipe)

Open at both ends

$$\lambda_n = \frac{2L}{n}$$

$$f_n = n \frac{v_{\text{sound}}}{2L}$$

$$n = 1, 2, 3, \dots$$

Open at one end

$$\lambda_n = \frac{4L}{n}$$

$$f_n = n \frac{v_{\text{sound}}}{4L}$$

$$n = 1, 3, 5, \dots$$

Reflect on the experience you've had so far with today's topic. What sorts of notes might you want to write on a note sheet for the exam (which you can test out by using for the rest of the worksheet and on this week's homework and quiz too)?

5) Below is an attempted solution to a problem. Here's the problem:

A guitar string of length 64 cm and stretched under a tension of 71.4 N has a certain fundamental frequency. How long would a pipe, closed at one end, need to be to play the same fundamental frequency? A 10 cm long piece of the guitar string has a mass of 0.36 g. The speed of sound in air is 340 m/s.

The answer shown is wrong.

A) Identify 4 errors in this solution that lead to an incorrect result.

$$\begin{aligned}
 f_{1, \text{string}} &= \frac{1}{2L} \sqrt{\frac{F_T}{\mu}} \quad \mu = \frac{m}{l} = \frac{0.36 \times 10^{-3} \text{ kg}}{0.64 \text{ m}} = 5.63 \times 10^{-4} \text{ kg/m} \\
 &= \frac{1}{(0.64 \text{ m})} \sqrt{\frac{71.4 \text{ N}}{5.63 \times 10^{-4} \text{ kg/m}}} = 556 \text{ Hz} \\
 f_{1, \text{pipe}} &= n \frac{v_{\text{sound}}}{2L_p} \Rightarrow L_p = \frac{n v_{\text{sound}}}{2 f_1} = \frac{(2)(340 \text{ m/s})}{(2)(556 \text{ Hz})} \\
 &= 0.61 \text{ m}
 \end{aligned}$$

B) Can you see a way that the problem could have been solved in a single step rather than two?

6) Suppose you have two speakers driven by the same source at 227 Hz. The speakers are set up as indicated below, facing one another and separated by 3 m. You are standing at a point exactly midway between them, indicated by the dot. Assume the speed of sound is 340.5 m/s.

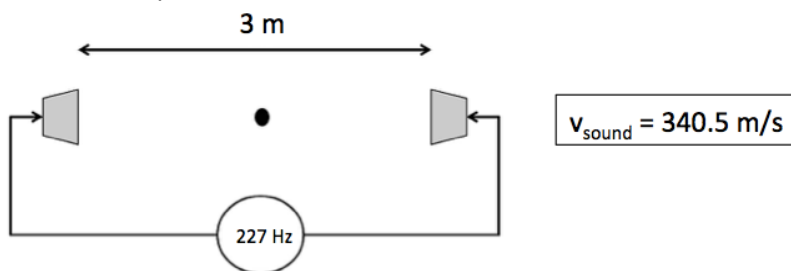

A) Imagine you move 37.5 cm to the right. Now, do you think you hear something or not?

Wave Interference
 Physics 103 – General Physics

B) To check your answer, complete the following pictures. The wave from the left speaker has been filled in. What does the wave from the right speaker look like at these same moments in time? (Hint: The two waves are mirror images of one another as they come out of the speakers.)

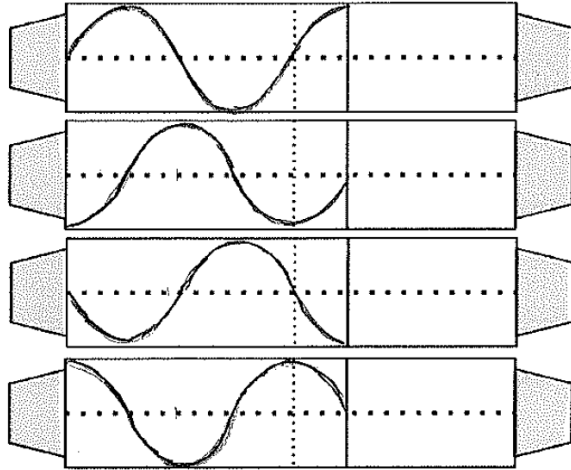

The gap between the vertical dotted line midway between the speakers and the solid line is 37.5 cm.

What fraction of a wavelength does that distance represent? This should help you draw what the waves from the right speaker look like.

C) Do these pictures match your answer to A?

D) Now calculate the path difference between the left speaker and the spot 37.5 cm to the right of center and between the right speaker and the same spot. What fraction of a wavelength is this path difference?

- 1) Distance from left speaker to solid line: _____
- 2) Distance from right speaker to solid line: _____
- 3) Path difference (1 minus 2): _____

E) Does this match up what you know about the conditions for destructive interference (that the path difference is equal to $n + \frac{1}{2}$ wavelengths)?

Wave Interference
Physics 103 – General Physics

7) The panels below show 'snapshot' graphs (y-vs-x) of transverse waves on a stretched string captured at different times. Draw the result of the interference (superposition) of the two waves in each case.

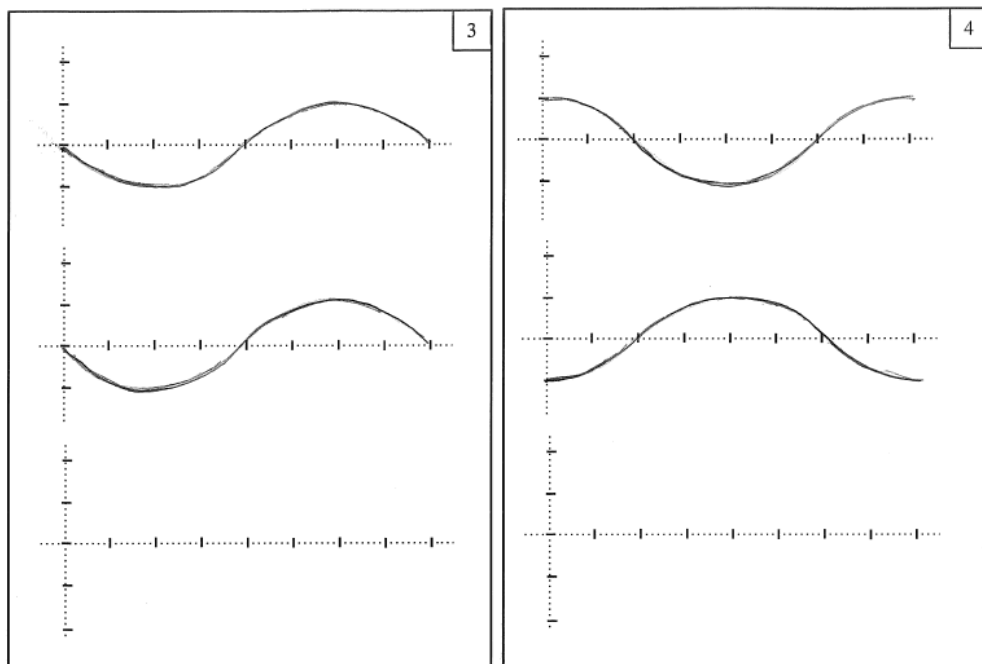
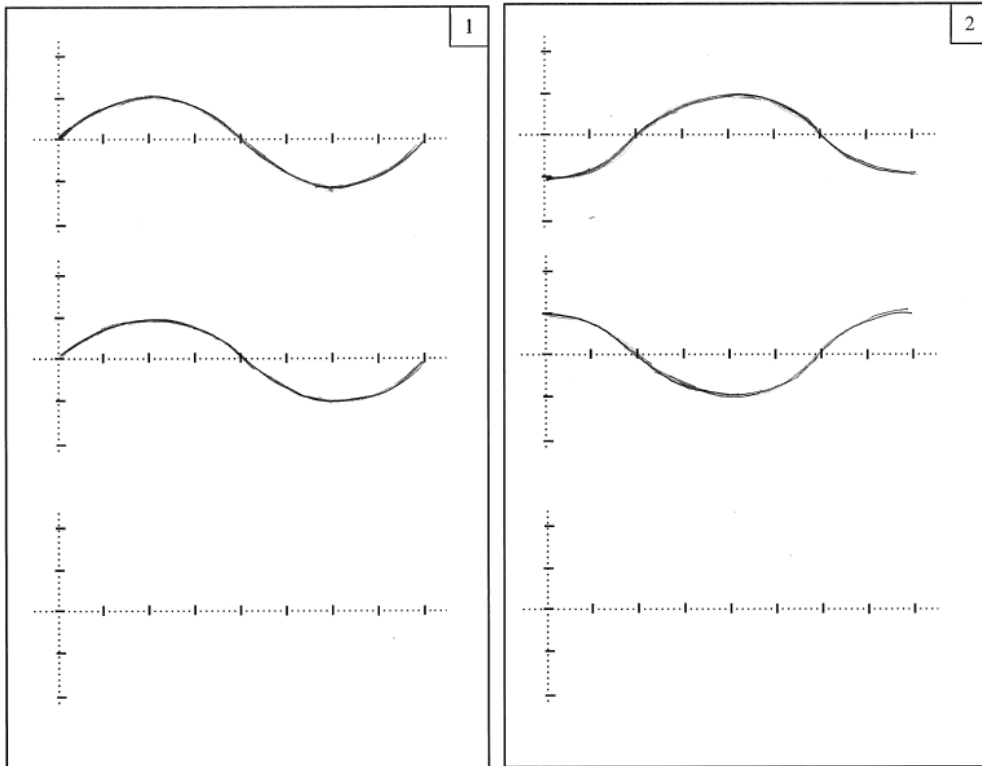

Wave Interference
Physics 103 – General Physics

8) The sequence of summed waves (the bottom-most ones) from problem 7 represents the standing wave on a string that is 80 cm long. Each box takes place at intervals of 1.25×10^{-3} s. The wave on top is traveling to the right. The wave in the middle is traveling to the left.

A) Which harmonic ($n = ?$) would this be?

B) What is the fundamental frequency for this string? (Hint: What is the frequency of the waves producing the second harmonic? How does that frequency relate to the fundamental frequency?)

C) What are the positions of the nodes (include the first and last node) of the third harmonic?

D) What about the positions of the antinodes for the fourth harmonic?

Wave Interference
 Physics 103 – General Physics

9) Two pulses move toward each other (as shown below), meet, and pass through each other. Each pulse moves at 2 squares per second. Use superposition to draw the shape of the string at each one-second interval.

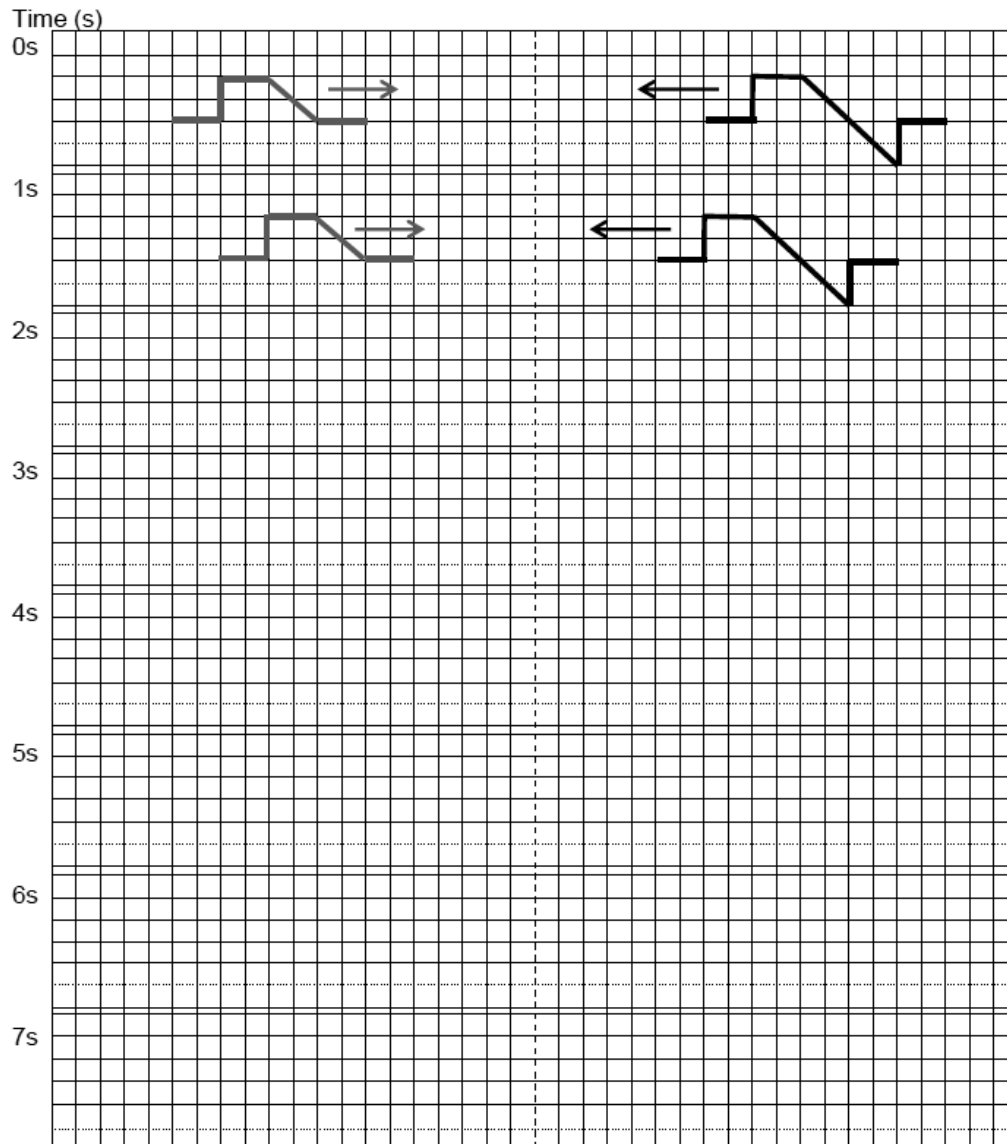

Sound – Group Sheet
Physics 103 – General Physics

Your group member names:

1) Which is the best definition of intensity?

- a) A measure of how much energy is released by a source of waves.
- b) A measure of how much power is felt due to nearby a source of energy per unit time, per unit volume.
- c) A measure of the rate at which energy is delivered to a volume.
- d) A measure of how the rate of energy radiating from a source is spread out in space around the source.
- e) A measure of the rate of oscillation of a source of waves.

2) If the intensity of a sound increases by a factor of 100, by how much does the intensity level of the sound increase in decibels? Hint: $\log(xy) = \log(x) + \log(y)$.

- a) 20 dB
- b) 4 dB
- c) 100 dB
- d) 36 dB
- e) 56 dB

3) Your friend is holding a tuning fork that is vibrating at 440 Hz. In which case do you hear a frequency greater than 440 Hz?



- a) Your friend runs to the right. You also run to the right at the same speed.
- b) Your friend runs to the right. You run to the left at the same speed.
- c) Your friend runs to the left. You run to the right at the same speed.
- d) Your friend runs to the left. You also run to the left at the same speed.
- e) Both you and your friend stand still.

Sound
Physics 103 – General Physics

Useful Expressions:

$$I = \frac{P_{\text{source}}}{4\pi r^2} \text{ (wave spreading in all directions)} \quad I_{\text{sound}} = \frac{p_{\text{max}}^2}{2\rho v_{\text{sound}}} = \frac{1}{2} \rho v_{\text{sound}} \omega^2 A^2$$

$$f_{\text{observed}} = \left(\frac{v_{\text{sound}} \pm v_{\text{observer}}}{v_{\text{sound}} \mp v_{\text{source}}} \right) f_{\text{source}} \quad \beta(\text{dB}) = 10 \log\left(\frac{I}{I_0}\right) \text{ where } I_0 = 10^{-12} \text{ W/m}^2$$

Reflect on the experience you've had so far with today's topic. What sorts of notes might you want to write on a note sheet for the exam (which you can test out by using for the rest of the worksheet and on this week's homework and quiz too)?

4) This question explores the technique of Doppler ultrasound, which can be used to measure the speed of blood moving through the body. These devices do this by measuring the shifted frequency of the waves reflected from the blood cells. The speed of ultrasound waves in human tissue is $v_{\text{sound}} \approx 1540 \text{ m/s}$. As you will see below, the Doppler shift occurs twice in this process.

A) Moving blood cells can be thought of as observers 'hearing', if you will, a frequency shifted by their motion toward or away from the ultrasound source. Medical ultrasound devices emit pressure waves (sound) with a frequency of $f_{\text{device}} = 2.0 \text{ MHz}$. If a blood cell is moving toward this source with a speed of $v_{\text{blood}} \approx 1.0 \text{ m/s}$, what frequency (call this f_1) is observed by the blood cell?

Sound
Physics 103 – General Physics

B) Now we can think of these blood cells as moving sources. The ultrasound device measures (observes) the frequency of these reflected waves. What frequency (call this f_2) is observed by the ultrasound device? (Hint: Think about what the source is and what the observer is for these reflected waves. Also, what is the frequency of this source?)

5) Try your hand at designing a Doppler shift question. Call the person making the sound A. Call the person listening to the sound B.

In the space below write a short description of how person A and person B are moving relative to one another, including a diagram of the situation. There should be at least one change in speed or direction of their motion as they move toward or away from one another. Also draw a frequency vs. time graph for the sound person B hears that shows how that observed frequency changes in time.

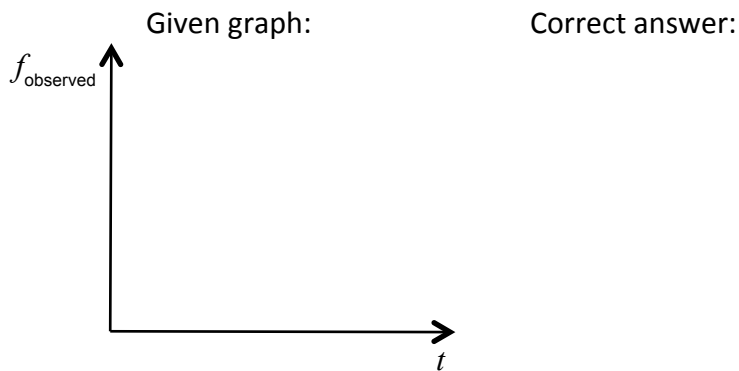

The description you wrote above will be the correct answer for the graph you drew. The question might read, “Which description matches the graph of the observed frequency vs. time?” To complete this multiple choice question you will need to come up with three incorrect motion descriptions below.

Incorrect answer:

Sound
Physics 103 – General Physics

Incorrect answer:

Incorrect answer:

If you like what you've created, take a picture of it and send it to your TA. You may see something like it on a future quiz or exam.

6) Intensity, I , is defined as the power per unit area. Humans can hear sounds as quiet as $I_0 = 10^{-12} \text{ W/m}^2$ all the way up to 10 W/m^2 when sounds become painful—a 10^{13} factor increase in intensity! Experiments have shown that if we increase the intensity of a sound by a factor of 10, people perceive it as about twice as loud. The fact that we hear a huge range in intensity and that we interpret 10-fold increases as about twice as loud led to the invention of decibel scale defined by $\beta(\text{dB}) = 10 \log\left(\frac{I}{I_0}\right)$ which also says that $I = I_0 10^{\beta/10}$.

A) Finish filling in the following table and use it to answer the questions below.

	β (dB)	Exponent, $\beta/10$	$10^{\beta/10} = I/I_0$	Intensity, $I = I_0 10^{\beta/10}$
1	20			
2				$2.0 \times 10^{-10} \text{ W/m}^2$
3	26	2.6	$10^{2.6} \approx 400$	$4.0 \times 10^{-10} \text{ W/m}^2$
4		3.0		
5	40			
6			$\approx 25,000$	
7				$6.3 \times 10^{-8} \text{ W/m}^2$
8		5.0		
9			$= 200,000$	
10	80			

B) How does the number decibels change if the intensity of sound doubles (changes by a factor of 2)?

Sound
Physics 103 – General Physics

- C) How does the number decibels change if the intensity of sound changes by a factor of 5?
- D) How does the number decibels change if the intensity of sound changes by a factor of 100?
- E) By what factor does the intensity change if the sound increases by 4 dB?
- F) By what factor does the intensity change if the sound increases by 10 dB?
- G) By what factor does the intensity change if the sound increases by 40 dB?
- 7) For a wire with linear density μ carrying waves of angular frequency ω , amplitude A , and propagation speed v_{wave} the average amount of energy passing a point on the wire in a second (Joules/second or Watts) is given by $P_{\text{wire, ave}} = \frac{1}{2} \mu v_{\text{propagation}} \omega^2 A^2$.
- A) Check that this expression has the correct units for power.

Sound
Physics 103 – General Physics

B) A long wire under tension is carrying the traveling wave illustrated in the snapshot at right. A one-meter section of the wire has a mass of 1 gram. The oscillation frequency is $f = 256$ Hz and the average power passing a point on the wire is 10 Watts. Find the tension on the wire and the wave amplitude.

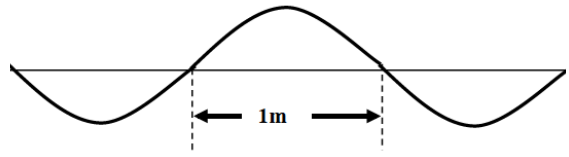

1) The human brain and spinal cord are immersed in the cerebrospinal fluid. The fluid is continuous between the cranial and spinal cavities. The pressure of the cerebrospinal fluid can be measured by means of a *spinal tap*. The person performing the spinal tap inserts a hollow tube into the spinal column and observes the height to which the fluid rises. If the fluid rises to a height of 138 mm, what is the gauge pressure in the spinal fluid in Pascals? (Assume that the spinal fluid has essentially the same density as water, 1000 kg/m^3)

- a) 0.92 kPa
- b) 1.35 kPa
- c) 2.76 kPa
- d) 3.31 kPa
- e) 4.99 kPa

2) Sometimes it is necessary to determine whether an accident victim has suffered a crushed vertebra that is blocking the flow of cerebrospinal fluid in the spinal column. Such conditions can be investigated by means of the *Queckenstedt test*. In this procedure the veins in the patient's neck are compressed to make the blood pressure rise in the brain. The increase in pressure in the blood vessels is transmitted to the cerebrospinal fluid. What should be the normal effect on the height of the fluid in the spinal tap?

- a) It should decrease.
- b) It should stay the same.
- c) It should increase.
- d) We can't tell without knowing the initial pressure.

3) A person in a boat floating in a small pond throws an anchor overboard. The anchor sinks to the bottom of the pond. What happens to the water level of the pond?

- a) It will decrease.
- b) It will stay the same.
- c) It will increase.
- d) It depends on the size of the anchor.

Fluid Statics
 Physics 103 – General Physics

Useful Expressions:

$$p = F/A \quad \rho = m/V \quad p_{\text{bottom}} = p_{\text{top}} + \rho g d \quad F_{\text{fluid,object}} = \rho_{\text{fluid}} V_{\text{displaced}} g$$

Reflect on the experience you've had so far with today's topic. What sorts of notes might you want to write on a note sheet for the exam (which you can test out by using for the rest of the worksheet and on this week's homework and quiz too)?

4) Consider the U-shaped tube to the right. The shaded portion is water. The un-shaded portion is air. Assume that changes in air pressure because of height inside the tube are so small that you can ignore them.

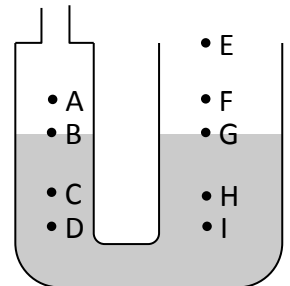

A) Group all of the points that are at the same pressure by drawing a large circle around them.

B) Number the groups from highest (1) to lowest (2,3,4, etc.) pressure.

5) A cylindrical object floats in a jar of water as shown.

A) Draw a free body diagram of the object in the box at right.

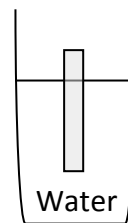

B) What is the magnitude of the buoyant force on the object? The mass of the object is 7.5 g.

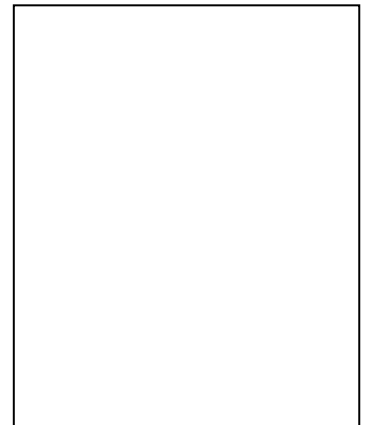

Fluid Statics

Physics 103 – General Physics

C) What is the volume of the water displaced? The density of water is $1 \text{ g/cm}^3 = 1000 \text{ kg/m}^3$.

D) Use your calculation in part C to determine what fraction of the object is under water. The volume of the object is 10 cm^3 .

E) Suppose you pour oil ($\rho_{\text{oil}} = 0.67 \text{ g/cm}^3 = 670 \text{ kg/m}^3$) on top of the water. You are holding the object in place as you pour. When you finally let go of it, will it move up or down? (Hint: Before the water was providing all the buoyant force needed to keep the object afloat. Now the oil is providing some of the buoyant force. What does this mean for the volume of water that the object will displace once you let it go?)

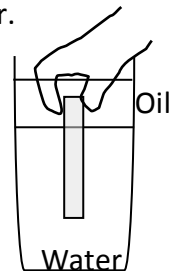

F) In the box at right draw a free body diagram for the object once it reaches its new equilibrium position after you let go. Assume that the layer of oil is thick enough that the top of the object never emerges into the air.

G) Calculate the fraction of the object that is under the surface of the water once it reaches its new equilibrium position. Make the same assumption about the thickness of the oil layer as in part f).

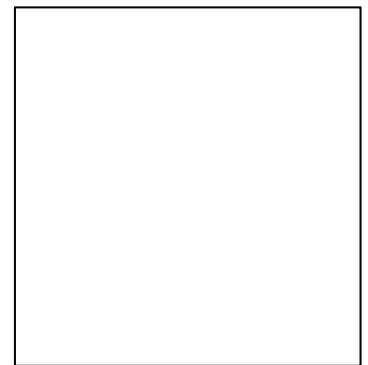

Fluid Statics
Physics 103 – General Physics

6) Here is a chance for you to write your own question about buoyancy using the situation pictured at right. That is, a stone is suspended in some fluid by a string connected to a scale. For this to happen in real life the stone must be of greater density than the fluid, but aside from that you are free to pick values as you see fit.

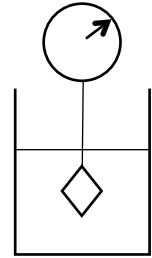

A) List all, or as many as you can, the quantities (variables) associated with this situation. Examples are fluid density, scale reading, etc.

B) Decide which of these you want to be the focus of the question. That is, which of the above will you ask your readers to solve for? Please be very specific.

C) Decide which quantities you need to give your readers so your question can be answered. This will take some playing around and you will find it is possible to pick values that are not self-consistent. What is meant here is that these quantities are all related in some way and cannot all be specified independently, such as mass, volume, and density. You should also strive to provide only the minimum number of given values required to achieve a solution.

Fluid Statics
Physics 103 – General Physics

D) Write your completed problem statement including the given values, and your solution.

7) Let's return for a moment to situation in problem 4. We set our pump to reverse and remove air from the left branch and apply a stopper preventing air from entering.

A) Why does sucking the air out cause the water level rise in the left side?

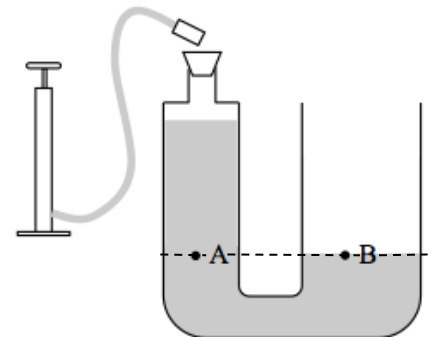

Fluid Statics

Physics 103 – General Physics

B) By inserting a pressure gauge through the stopper you find the air pressure (absolute, not gauge pressure) above the water in the left side is $\frac{1}{2}$ atmospheric pressure. Point B is right at the water level (not under) and point A is at the same level. Find the absolute pressure at point A. Use 10^5 Pa for atmospheric pressure.

C) How far above point A is the water in the left branch? The density of water is $1 \text{ g/cm}^3 = 1000 \text{ kg/m}^3$.

D) No matter how tall the left side is and no matter how air you remove there is a maximum height to which you can get the water to rise. What is that height?
Hint: How low can the absolute air pressure be in the left side?

Ideal Fluid Dynamics – Group Sheet
Physics 103 – General Physics

Your group member names:

1) The main blood vessel carrying blood out of your heart is the aorta. It carries blood down towards the legs. In your abdomen it splits into two, the common iliac arteries. The diameter of a typical aorta is 2 cm, while the iliac arteries typically have diameters of about 1 cm. A typical value for the speed of the blood in the aorta is $v_A = 30$ cm/s when the heart is contracting. While this is occurring, the speed of the blood flowing in the iliac arteries will be closest to:

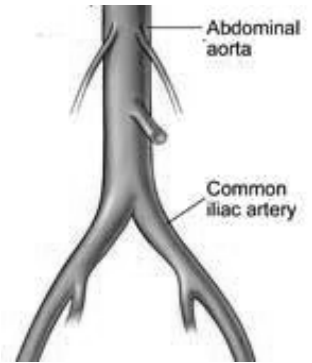

- a) 120 cm/s
- b) 60 cm/s
- c) 30 cm/s
- d) 15 cm/s
- e) 7.5 cm/s
- f) It's not close to any of these.

2) There is an outward bulge (that is, an increase in the radius) in the wall of an artery because of a weak spot in the wall. What can you say about the velocity of blood flowing through this bulge?

- a) It is greater than the velocity before or after the bulge.
- b) It is less than the velocity before or after the bulge.
- c) It is the same as the velocity before or after the bulge.
- d) We can't tell anything about the velocity without knowing the pressure.

3) Why does your answer to 2 above pose a serious risk to the owner of the artery?
(Hint: Think about pressure.)

Ideal Fluid Dynamics
Physics 103 – General Physics

Useful Expressions:

$$A_1 v_1 = A_2 v_2 \quad p_{\text{gauge}} = p_{\text{absolute}} - p_{\text{atmosphere}} \quad (\text{note sometimes } p_{\text{atmosphere}} \text{ is written } p_0)$$

$$p_1 + \frac{1}{2} \rho v_1^2 + \rho g y_1 = p_2 + \frac{1}{2} \rho v_2^2 + \rho g y_2 \quad (\text{for laminar, non-frictional flow only})$$

Reflect on the experience you've had so far with today's topic. What sorts of notes might you want to write on a note sheet for the exam (which you can test out by using for the rest of the worksheet and on this week's homework and quiz too)?

4) Water is flowing through the pipe shown below. You can assume that the water fills the pipe completely at points 1 through 6. Note that the picture is not to scale.

Your job is to find the absolute pressure, the kinetic energy density (which means finding the water's velocity), and the potential energy density at each point, as well as the height h of the stationary water column. Use this information to fill out the table below. A few values are filled in to get you started.

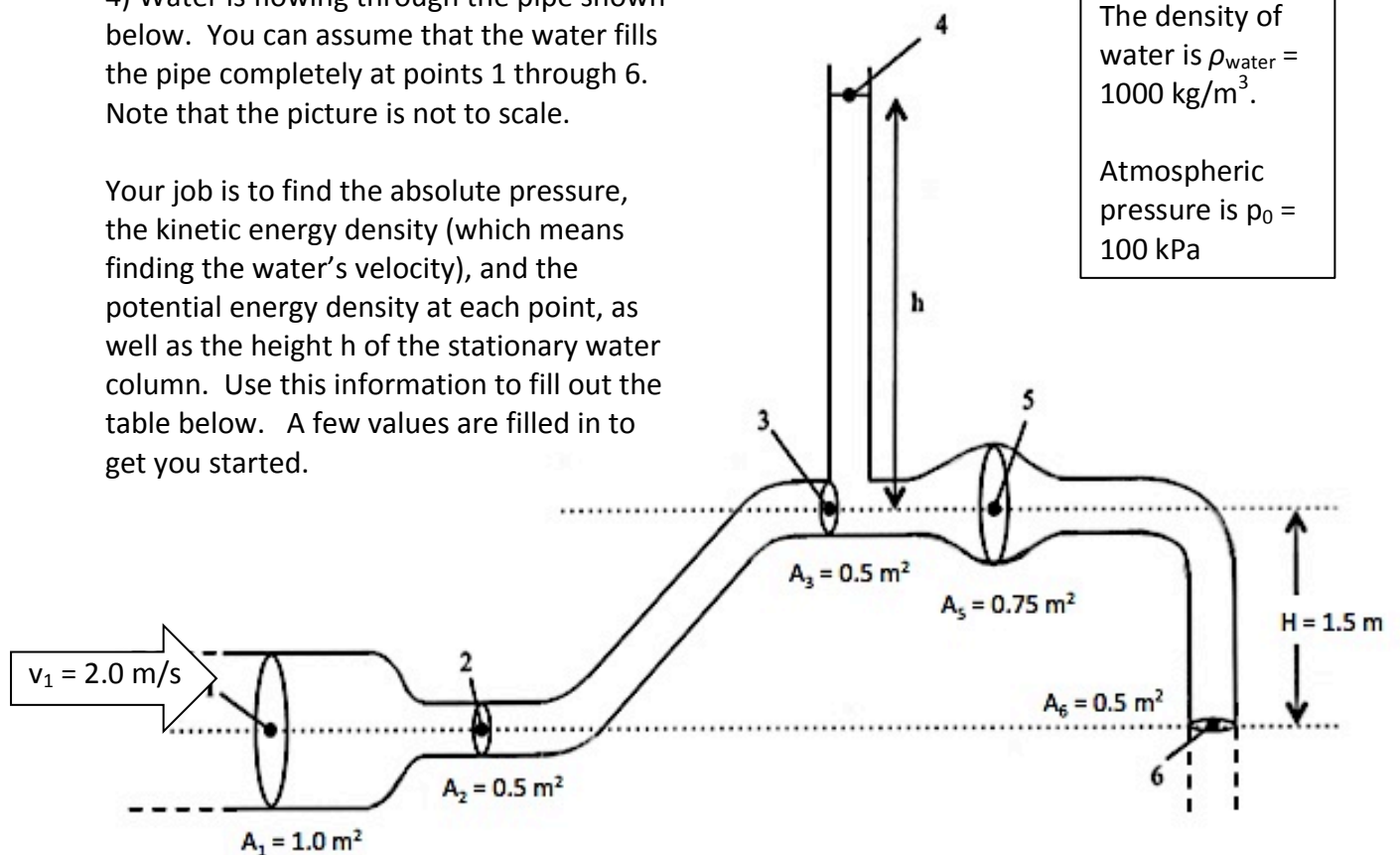

Ideal Fluid Dynamics
 Physics 103 – General Physics

All entries in the table are in units of $\text{kJ/m}^3 = \text{kPa}$.

	1	2	3	4	5	6
$K/\text{m}^3 = \frac{1}{2} \rho v^2$	2.0			0		
$U/\text{m}^3 = \rho gy$	0	0				0
p_{absolute}	125					
$E_{\text{total}}/\text{m}^3$						

$h =$

Here are some hints on how to approach this problem:

- You can assume that $y = 0$ at the lowest dotted line.
- How does the height of the stationary water column, h , relate to the pressure at point 3?
- The total energy density in the fluid is a product of three pieces: kinetic energy density, potential energy density, and pressure.
- What does the velocity of the fluid at each point depend on?

5) Below is a picture of the end of the pipe from question 4. Draw a picture of how the pipe should continue from point 6 so that the water pressure will increase. You can change either or both the area of the pipe and its elevation.

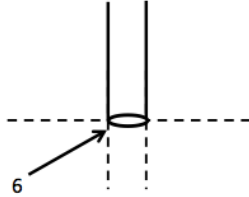

6) Like the previous question, the pipe system shown contains flowing water that fills the pipe at every location. Use this picture to determine whether the value in the table **Increases, Decreases, or Stays the Same**.

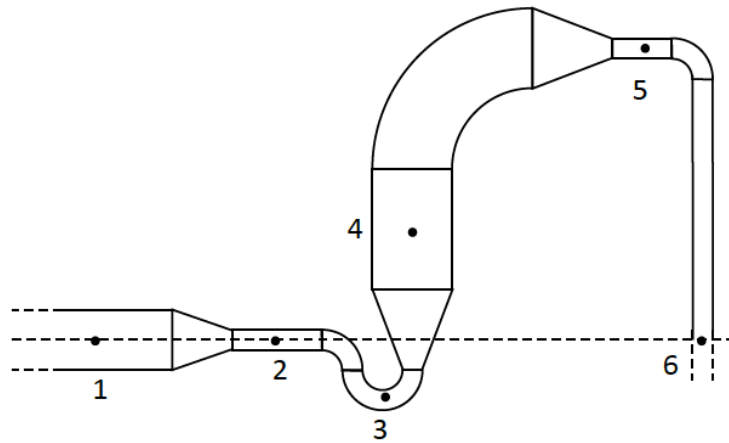

Initial Point	Final Point	From the initial to the final point, the total energy density of the fluid:	From the initial to the final point, the potential energy density of the fluid:	From the initial to the final point, the kinetic energy density of the fluid:	From the initial to the final point, the pressure in the fluid:
1	2				
2	3				
1	5				

7) One of the prime motivators for the development of fluid mechanics in the 1700s was the mining industry's need to pump water up and out of ever deeper mines since any hole in the earth will fill to the level of the local water table.

We want to find the pump gauge pressure, p_{pump} , required to remove water from a mine of depth h at a volumetric flow rate of Q (which is adjusted to match the rate at which water is seeping into the mine).

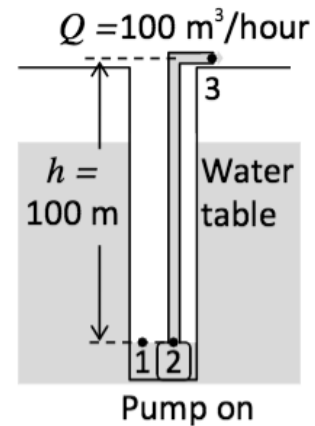

The figure shows a running submersible pump located at the bottom of the mine and a pipe of area A_{pipe} that connects the pump to the surface. The water is moving up the pipe with velocity v_{pipe} . Location 1 is at the surface of nearly stationary water pooled at the bottom of the mine. Location 2 is at the same level but just inside the pump, which is creating high pressure in order to lift the water upward. Once it passes through the pump, the water at point 2 is moving upward at speed v_{pipe} . Location 3 is at the mouth of the pipe. The water here is also moving at speed v_{pipe} .

A) If the cross sectional area of the pipe is 0.2 m^2 , find the speed of water in the pipe, v_{pipe} .

B) What is the total energy density in the water at point 1? (Hint: Changes in height of 100 m don't change pressure in air enough to notice so we can assume the air at the bottom of the mine is also at atmospheric pressure.)

C) What is the total energy density of the water at point 3?

Ideal Fluid Dynamics
Physics 103 – General Physics

D) What must happen between point 1 and point 3? (Hint: Why might the energy of a system change?)

E) How much work per cubic meter of water must the pump do?

F) Assuming the pump does all this work by increasing the pressure, what is the absolute pressure created by the pump p_{pump} ?

Viscosity and Turbulence – Group Sheet
 Physics 103 – General Physics

Your group member names:

1) Estimate the likelihood that you will see turbulent flow in each of the following situations, where 1 is least likely and 5 is most likely.

- 1 2 3 4 5 Air rising quickly through a wide chimney
- 1 2 3 4 5 Blood flowing rapidly through a narrow capillary
- 1 2 3 4 5 Honey moving slowly through large diameter pipes in a factory
- 1 2 3 4 5 A slow mudslide down a narrow ditch

	Density (kg/m ³)	Viscosity (mPa•s)
Air	1.23	0.0171
Water	1000	1.002
Blood	1060	2.084
Corn Oil	1370	65
Honey	1420	10,000
Mud	1730	200

2) The picture to the right shows a water works supplying water to a number of homes. The pressure of the water in the main pipe at the works is p_2 . The pressure of the water in the main pipe near the homes is p_1 . Why might the water pressure in the homes be lower in the summer, when people are using more water to water lawns and fill swimming pools, than in the winter, when use is much lower? (Select only one.)

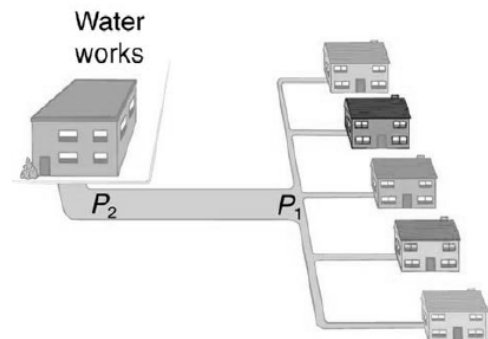

- a) If more water is flowing through the main pipe, the overall flow is lower, which means that p_1 must be smaller.
- b) Pushing more water through the main pipe requires a larger pressure drop. Since p_2 stays the same, p_1 must decrease.
- c) A larger flow of water means a smaller pressure drop, so p_1 must become nearly equal to p_2 .
- d) Fast moving water is at lower pressure, so the more water moves through the main pipe per unit time, the lower p_1 will become.
- e) The Equation of Continuity says that the larger the flow, the lower the velocity and low velocity water means less pressure.

Viscosity and Turbulence
Physics 103 – General Physics

Useful Expressions:

$$A_1 v_1 = A_2 v_2 \quad (\text{for all flows})$$

$$p_1 + \frac{1}{2} \rho v_1^2 + \rho g y_1 = p_2 + \frac{1}{2} \rho v_2^2 + \rho g y_2 \quad (\text{laminar, non-viscous only})$$

$$Re_1 = \frac{\rho l v}{\eta} \quad Re_2 = \frac{2 \rho r v}{\eta}$$

(In both cases, small numbers mean viscosity is more important and turbulence is less likely. High numbers mean viscosity is less important and turbulence is more likely.)

$$\Delta p = QR \quad R = \frac{8 \eta l}{\pi r^4} \quad Q = \frac{\Delta p \pi r^4}{8 \eta l}$$

Reflect on the experience you've had so far with today's topic. What sorts of notes might you want to write on a note sheet for the exam (which you can test out by using for the rest of the worksheet and on this week's homework and quiz too)?

3) An intravenous system is supplying saline solution with viscosity $\eta = 10^{-3} \text{ Pa s}$ and density 1025 kg/m^3 to a patient at the rate of $Q = 0.12 \text{ cm}^3/\text{s}$ through tubing with a radius $r_{\text{tubing}} = 6 \text{ mm}$ and a needle of radius $r_{\text{needle}} = 0.15 \text{ mm}$ and a length of $l_{\text{needle}} = 2.5 \text{ cm}$. The **gauge** pressure in the patient's blood vessel into which the needle is inserted is $p_{1,\text{gauge}} = 8 \text{ mm Hg}$ (or 1067 Pa). The **gauge** pressure at the surface of the solution in the IV bag is atmospheric pressure ($p_{0,\text{gauge}} = 0 \text{ Pa}$).

For this problem, we will assume a simplified system in which the solution flows into the patient's arm driven by the pressure gradient between the surface of the fluid in the IV bag and the pressure in the patient's arm. Usually, there is a drip chamber that controls the flow.

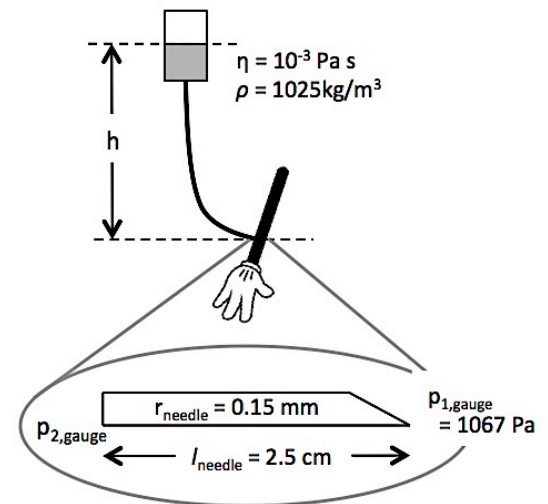

Viscosity and Turbulence
Physics 103 – General Physics

You need to find the height h above the arm the IV bag must be raised so that the flow rate is $0.12 \text{ cm}^3/\text{s}$.

A) Start by converting the flow from cm^3/s to m^3/s . (If we're measuring pressure in Pascals, then our safest option is to express all of our parameters in terms of meters, kilograms, and seconds.)

B) Find the pressure drop across the needle (with radius and length given above) necessary to have a volumetric flow of rate (the one you found in A) of saline solution with the specified viscosity through the needle.

C) Indicate the necessary gauge pressures at back end ($p_{2,\text{gauge}}$) and front end ($p_{1,\text{gauge}}$) of the needle below. (Remember, $\Delta p = p_{2,\text{gauge}} - p_{1,\text{gauge}}$.)

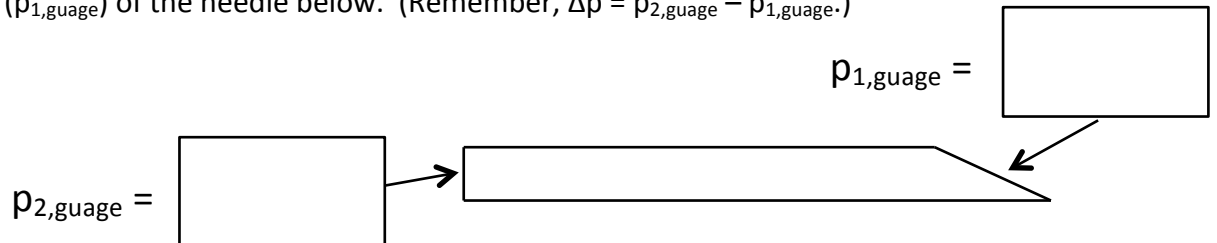

D) The pressure at the back end of the needle is, in this highly simplified scenario, created by the height difference, h , between the surface of the solution in the IV bag and the back end of the needle. In order to relate h and $p_{2,\text{gauge}}$, we're going to treat the saline solution between the IV bag and the needle as a stationary column of fluid (that is, use the tools of static fluids rather than dynamic). Is this a reasonable assumption? (Hint: Using Q , determine what the velocity of the solution inside the tubing from the IV bag to the needle is.)

E) Find the height, h .

F) Calculate the change in kinetic energy density in the solution between just before it enters the needle, where it is hardly moving ($v_{\text{tubing}} \sim 0$), and when it is inside the needle, where it is moving (quite fast, actually). You will need to compute v_{needle} from Q and the needle area. Where do you think this energy comes from?

G) If the patient stands up or the bag is lowered, the pressure gradient can be reversed, which means blood will stop and then start flowing backwards through the needs. At what height, h , would this just start to happen? (Hint: What is the pressure difference across the needle at the moment the flow stops?)

H) What will the flow into the patient's arm be if $h = 1.0 \text{ m}$?

4) One of the ways that penguins have adapted to standing on ice involves the constriction of vessels carrying blood to their feet, reducing the flow of blood. Assume that the pressure drop along these vessels is the same in all cases (before and after the change in radius) since in viscous fluids the pressure gradient does depend on the flow.



A) In order to reduce blood flow to 40% of its original value, by what percentage should the blood vessels be constricted?

B) In bitterly cold conditions, blood flow can be reduced to 1% of its original value. By what percentage should vessels be constricted in this case?

5) This is a purely conceptual question about the differences and similarities between the behaviors of viscous and non-viscous fluids. In all cases and at all locations and regions below, there is no turbulence and all flows are laminar. You are shown two identical tanks filled to the same level and spilling fluid out of the tube at the bottom. The only difference is that one tank (A) is filled with a non-viscous fluid and the other is filled with a viscous fluid (tank B). We only want to talk about the differences cause by viscosity and any changes in kinetic energy density, not those cause by fluids having difference densities so we will assume that $\rho_A = \rho_B$. Each tank has 5 locations (1 through 5) and three regions (I, II, III) separated by dotted lines.

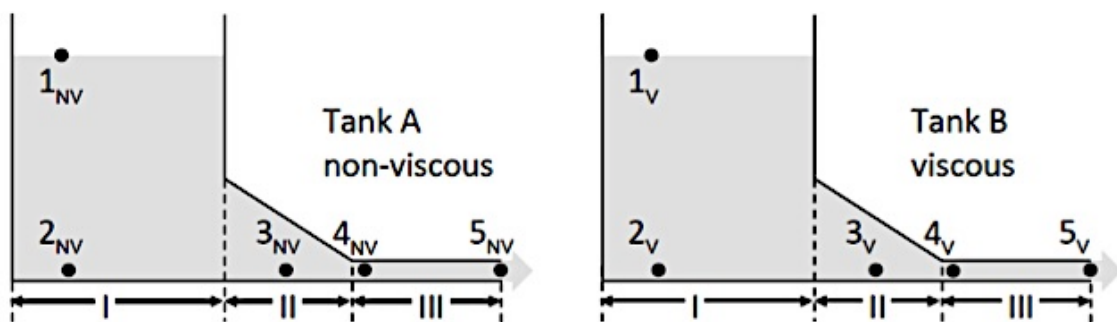

A) For each region on the diagrams above, state the fluid behavior in terms of “at rest,” “constant speed,” “speeding up,” or “slowing down.” Do this for both tanks.

Viscosity and Turbulence
Physics 103 – General Physics

B) How does the velocity at 5A compare to that at 5B for each tank?

C) How does the velocity at 4A compare to that at 4B for each tank?

D) How does the pressure drop in region III compare between the two tanks?
That is, compare $\Delta p_{4 \rightarrow 5, A}$ to $\Delta p_{4 \rightarrow 5, B}$. (Hint: Without math, you should know what this is in tank A for the non-viscous fluid.)

E) Similarly, compare the pressure drops in region II. Here you need to consider both pressure drops due to viscosity and due to the change in kinetic energy density.

F) Compare the gauge pressures (qualitatively) at each point in tank A to the same points in tank B.

Temperature, Kinetic Theory, and Gas Laws – Group Sheet
Physics 103 – General Physics

Your group member names:

1) One of the things you'll need to get used to doing over the next couple of weeks is converting between temperature scales. Probably the most common conversion you'll have to make is between degrees Celsius and Kelvin. (Quiz, homework, and exam problems will often give you temperatures in Celsius, while equations like the Ideal Gas Law require measurements in Kelvin).

A) For practice, convert the following temperatures from Celsius to Kelvin:

18° C

78° C

-164° C

251° C

0° C

B) Now convert the following temperatures from Kelvin to Celsius:

362 K

0 K

132 K

8 K

1,289 K

2) Next time you walk down the sidewalk, you might notice that there are gaps between the slabs of concrete. This is so that the sidewalk doesn't buckle when the temperature is high. Suppose you measure the gap between two 1-meter long segments of concrete to be 5 mm on a very warm 37° C day. What will the gap between them be on a very cold -20° C day? The coefficient of linear expansion of concrete is $8 \times 10^{-6} \text{ K}^{-1}$. Also assume that each slab is fixed at its far end – the only motion caused by thermal change is in the gap between them. (Hint: Remember to account for the expansion of both slabs.)

- a) 0.912 mm
- b) 4.088 mm
- c) 10.912 mm
- d) 5.912 mm
- e) 0.456 mm

Temperature, Kinetic Theory, and Gas Laws
Physics 103 – General Physics

Useful Expressions:

$$K_{\text{trans,ave}} = \frac{1}{2} m v_{\text{RMS}}^2 \quad \text{For an ideal gas: } K_{\text{trans,ave}} = \frac{3}{2} kT \quad \text{and} \quad v_{\text{RMS}} = \sqrt{\frac{3kT}{m}} = \sqrt{\frac{3RT}{M}}$$

$$\Delta L = \alpha L_0 \Delta T \quad \Delta V = \beta V_0 \Delta T \quad \text{If } \Delta T \text{ is very small for an isotropic solid, } \beta = 3\alpha$$

$$pV = NkT = nRT$$

Reflect on the experience you've had so far with today's topic. What sorts of notes might you want to write on a note sheet for the exam (which you can test out by using for the rest of the worksheet and on this week's homework and quiz too)?

3) Suppose you have a gas confined to a small box.

A) Below is a representation of the molecules of the gas and their velocities. Draw a picture in which the gas is heated up and a picture in which the gas is cooled down.

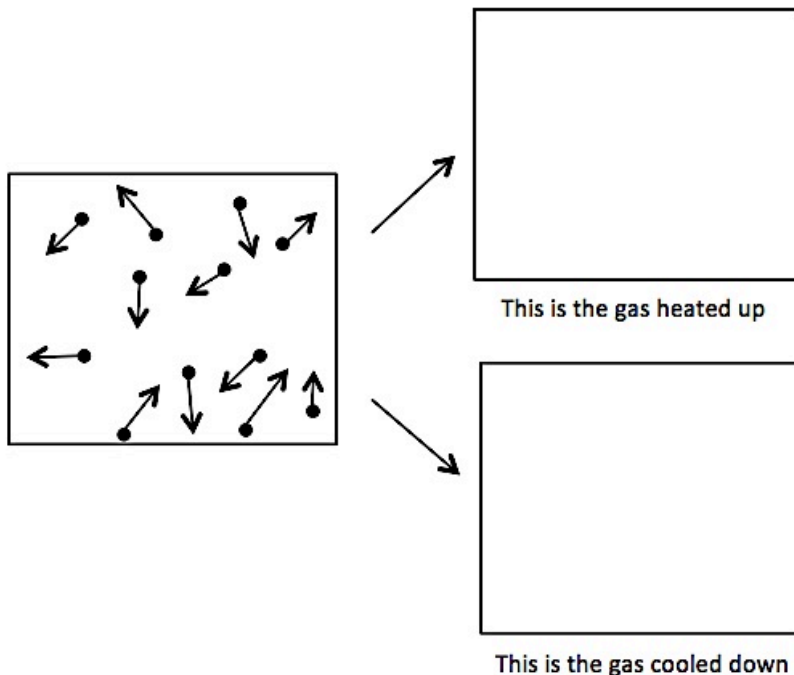

Temperature, Kinetic Theory, and Gas Laws
Physics 103 – General Physics

iii) How can we express the relationship between the initial and final p and initial and final T? To find out, complete the following expressions:

$$\frac{p_0}{\boxed{}} = \frac{\boxed{}}{T_f} \quad p_f = \boxed{} p_0 \quad T_f = \boxed{} T_0$$

iv) We have an ideal gas at an initial temperature of 25° C. What do we need to increase the temperature of the gas to in order to double the pressure?

B) Now, let's look at what happens if we keep p constant.

i) Can you imagine a real-life scenario in which the pressure of a gas is kept constant? When might that happen?

ii) If p is constant, the two changeable parameters are V and T. Rewrite the Ideal Gas Law so that T is on one side of the equation and V is on the other. Fill in the box below with all the things that remain constant.

$$T = \boxed{} V$$

Temperature, Kinetic Theory, and Gas Laws
Physics 103 – General Physics

iii) How can we express the relationship between the initial and final V and initial and final T? To find out, complete the following expressions:

$$\frac{T_0}{\boxed{}} = \frac{\boxed{}}{V_f} \quad T_f = \boxed{} T_0 \quad V_f = \boxed{} V_0$$

iv) We have a gas in a container that has an initial volume of 2 liters. If we reduce the temperature by 30%, what is the final volume of the container?

5) The case in which we hold temperature constant and let pressure and volume vary is a little more complex. But with all the practice you've just had, you should be able to handle it.

A) Rewrite the Ideal Gas Law so that V is on one side and p is on the other.

B) How would you describe the relationship between p and V? If p goes up, what does V do? What happens if p goes down?

- C) The temperature of a gas is fixed, the initial pressure is 2.0×10^5 Pa, and the initial volume is 2 L. What is the final pressure if we change the volume to 0.5 L?
- 6) Suppose you drop a metal sphere with a radius $r_{0,s} = 10.01$ cm into a ring with an inner radius $r_{0,r} = 10.00$ cm. Both objects are at $T_0 = 22^\circ$ C. The thermal expansion coefficient for the material making up the sphere is $\alpha_s = 5 \times 10^{-6} \text{ K}^{-1}$. The thermal expansion coefficient for the material making up the ring is $\alpha_r = 25 \times 10^{-6} \text{ K}^{-1}$. At what temperature will the sphere fall through the ring? You are welcome to go ahead and solve this problem directly, but on the next page are some hints if you want them.

HINT #1: What does “the sphere will fall through the ring” mean in mathematical language? The sphere will fall through the ring when:

- a) The radius of the sphere will double.
- b) The radius of the ring will be larger than the radius of the sphere.
- c) The temperature of the sphere will equal the sphere of the ring.
- d) The radius of the sphere will equal the radius of the ring.
- e) The temperature of the ring will be greater than the temperature of the sphere.

Temperature, Kinetic Theory, and Gas Laws
Physics 103 – General Physics

HINT #2: When we find the temperature at which $r_{f,s} = r_{f,r}$, will it be higher or lower than the initial temperature of the sphere and ring, T_0 ?

- q) T_f will be higher than T_0
- b) T_f will be lower than T_0
- c) T_f will equal T_0

HINT #3: Which of the following gives the radius of the sphere at T_f ?

- a) $r_{f,s} = \alpha_s r_{0,s} \Delta T$
- b) $r_{f,s} = r_{0,s} + \alpha_s r_{0,s} \Delta T$
- c) $r_{f,s} = \alpha_s r_{0,s} T_f + \alpha_s r_{0,s} T_f$
- d) $r_{f,s} = \alpha_s r_{0,s} T_f$
- e) $r_{f,s} = r_{0,s} + \alpha_s r_{0,s} T_f$

Heat and Heat Transfer – Group Sheet
Physics 103 – General Physics

Your group member names:

1) Below are two pictures of the velocities of molecules of an ideal gas in a canister of constant volume. Use these pictures to explain why increasing the temperature of a gas and keeping the volume constant will result in increased pressure.

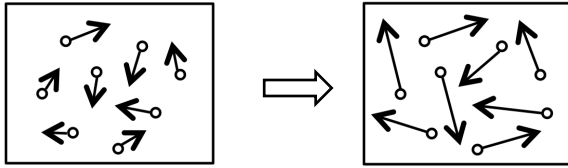

2) Heat (Q) is added to a 100 g piece of ice at a steady rate so that the ice converts first into liquid water and then evaporates completely, all at the same pressure of 1 atm. Which of the following qualitative plots of temperature versus energy may best represent the process? In each case, an argument for the correctness of the plot offered by one of your classmates is given. (Hint: More than one argument may be correct as far as they go, but only one is relevant.)

a)

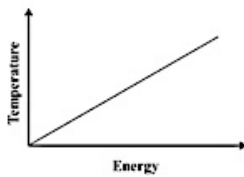

“The energy of the water will be increasing constantly even if there are three different phases (so the line will be straight) not stepwise.”

b)

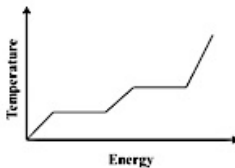

“First the temperature of the ice would rise until it began to melt. Then the temperature would be steady while it completed melting; after which the temperature would continue to rise. Then, the temperature will rise enough for the water to evaporate to steam. The temperature will then be steady while everything evaporates and then the temperature will rise again.”

c)

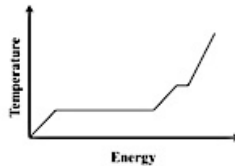

“You need to have a warming period where the ice melts. Then you need to have a long period where a lot of energy can be poured into the ice to warm it up to the point where it will boil and vaporize.”

d)

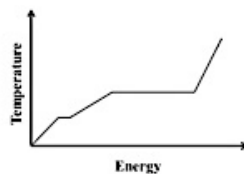

“This is because it takes more energy to make steam from liquid water than it does to make liquid from the ice.”

Heat and Heat Transfer
Physics 103 – General Physics

Useful Expressions:

$$Q = mc\Delta T \quad Q = \pm mL \quad P_R = \epsilon\sigma AT^4 \quad \text{where } \sigma = 5.7 \times 10^{-8} \text{ W/m}^2 \cdot \text{K}^4$$

$$P_C = \frac{Q}{\Delta t} = k \frac{A}{L} (T_H - T_C) \quad L_f = 334 \times 10^3 \text{ J/kg} \text{ and } L_v = 2260 \times 10^3 \text{ J/kg} \text{ for water}$$

Reflect on the experience you've had so far with today's topic. What sorts of notes might you want to write on a note sheet for the exam (which you can test out by using for the rest of the worksheet and on this week's homework and quiz too)?

3) Let's model the conduction of heat from object A to object B through an object C in analogy to the flow of a viscous fluid from location A to B through a pipe, C. Which parameters of the fluid system (Left Column) are similar to the parameters listed for the thermal system (Right Column)?

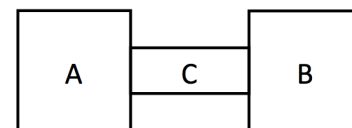

Fluid Flow

- The radius of the pipe C
- The pressure in the fluid at B
- The length of the pipe C
- The pressure difference between A and B
- The pressure in the fluid at A

Thermal Conduction

- The length of C
- The temperature of A
- The x-sectional area of C
- The temperature of B
- The temperature difference between A and B

Heat and Heat Transfer
Physics 103 – General Physics

4) As a person generates energy, much of this energy needs to be dissipated. The primary mechanisms of dissipating energy are radiation, evaporation of sweat, and conduction between skin and the surrounding air.

A person riding a bicycle has a body temperature of 37°C , and the outside temperature is 20°C . Assume the rider's skin has an area of 2 m^2 and emissivity of 0.97. The latent heat of vaporization for moisture evaporated from the skin is $2,430\text{ kJ/kg}$. We want to find out how much energy this person dissipates in 1 hour.

A) How much energy per second will the rider dissipate through radiation? How much energy will this amount to in an hour? (Note that this isn't the whole story, since the rider is also absorbing heat via radiation from the environment. This would make actual heat loss due to thermal radiation much lower than the number here.)

B) If the rider loses 0.42 kg of water through perspiration during the hour-long ride, what is the energy lost? (Assume this energy loss comes entirely through the phase change of water into water vapor.)

C) If the tissues between the core of the body (at 37°C) and the air (at 20°C) have an average k of $0.27\text{ W}/(\text{m}\cdot\text{K})$ and an average thickness of 3.8 cm , how much energy does the rider lose through conduction in an hour?

D) If 1 Calorie (1 kcal or 1 food calorie) is 4186 J , how many Calories does the total energy the rider loses in an hour through perspiration and conduction? (We'll exclude radiation because of the complexity mentioned above.)

Heat and Heat Transfer
Physics 103 – General Physics

5) You have an insulated tub of tea that you'd like to turn into iced tea. The mass of the tea, m_{tea} , is 1.5 kg and its initial temperature, $T_{i,\text{tea}}$, is 70° C. You'd like the final temperature of the tea, T_f , to be 10° C. You'd like to know what mass, m_{ice} , of ice at an initial temperature, $T_{i,\text{ice}}$, of 0° C you need to add.

A) When you add the ice, what will happen to the temperature of the tea?

B) When a substance cools down, energy is flowing out of it to somewhere else. Where is the energy from the cooling tea going?

C) When you add the ice, what will happen to the temperature of the ice at first?

D) When the ice is no longer ice, what happens to the temperature of the water it becomes?

E) Now you're ready to write an equation for the flow of energy in the tea-ice-water system using the following: m_{tea} , m_{ice} , C_{tea} , C_{water} , L_{water} , $T_{0,\text{tea}}$, $T_{0,\text{water}}$, T_f . In the left box, write expressions for the changes in energy of substances that are cooling down. In the right box, write expressions for changes in energy of the substances that are warming up or changing phase. By the conservation of energy, the sum of these two need to be zero.

	+		= 0
--	---	--	-----

Heat and Heat Transfer
Physics 103 – General Physics

F) Solve this equation for m_{ice} to find out how much ice you need to add to the water. Assume the specific heat of tea is the same as that of water, which equals $1.00 \text{ cal/g } ^\circ\text{C}$. The latent heat of fusion of water is 79.7 cal/g . You may also need to know that $1 \text{ cal} = 4.186 \text{ J}$ and $1 \text{ kg} = 1000 \text{ g}$.

$$m_{\text{ice}} = \boxed{}$$

6) Suppose you have a container of 600 g of water at 20°C . You add a block made of some metal that has a temperature of 80°C to the water. The block has a mass of 400 g. The final temperature of the water and block are 22°C . You don't know the specific heat of the block.

A) What was the thermal energy gained by the water?

B) Fill your result from part A into the first box below. What should you write in the second and third boxes? (Hint: The second box should contain an equation, not a number.)

Thermal energy gained by water	Thermal energy lost by block	Total change in thermal energy
<input style="width: 100%; height: 40px;" type="text"/>	<input style="width: 100%; height: 40px;" type="text"/>	<input style="width: 100%; height: 40px;" type="text"/>
	+	=

Heat and Heat Transfer
Physics 103 – General Physics

C) Now use what you have in part B to solve for the specific heat of the block.

D) Suppose you want to lower the temperature of the water to 14°C by placing the same block into it. What should the initial temperature of the block be now? (You can use the method above or just work with equations here.)

E) Now say you wanted to put the block into the contained and turn all the water into steam. How hot would you need to make the block to do this? (The latent heat of vaporization of water is 540 cal/g .)

F) Given that most metals boil over 3000°C , is it likely you'd be able to actually make part E happen in the real world?

Thermodynamic Processes – Group Sheet
 Physics 103 – General Physics

Your group member names:

1) Circle the correct thermal process(es) for each of the statements below about ΔU , Q , and W_{by} . You may need to select more than one thermal process for each statement. The dotted lines represent isotherms. The circle is the initial state of the gas.

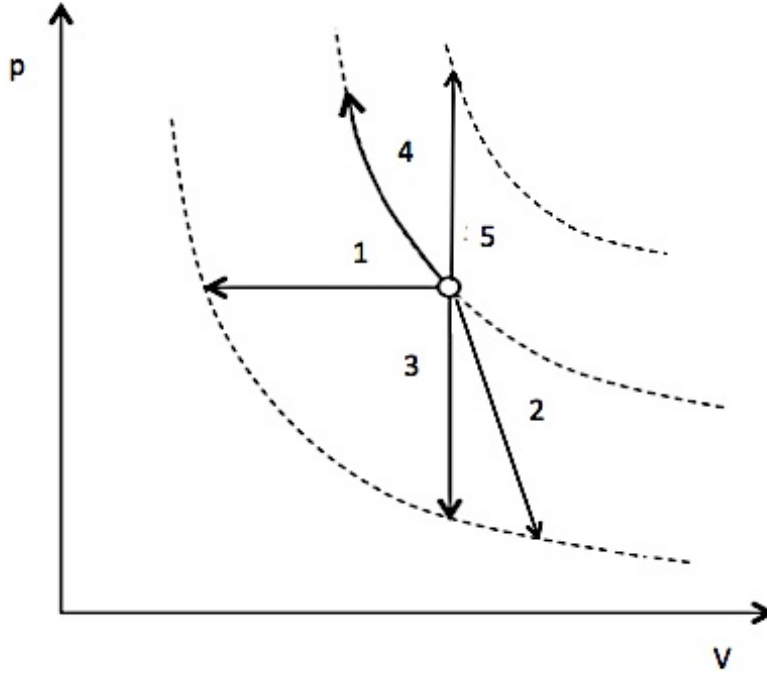

During which thermal process(es) will the internal energy of the gas increase?

1 2 3 4 5 none

During which thermal process(es) will the internal energy of the gas decrease?

1 2 3 4 5 none decrease?

During which thermal process(es) will the gas do positive work?

1 2 3 4 5 none

During which thermal process(es) will the gas do negative work?

1 2 3 4 5 none

During which thermal process(es) was thermal energy definitely added to the gas?

1 2 3 4 5 none

Thermodynamic Processes
Physics 103 – General Physics

Useful Expressions:

$$\Delta U = Q - W_{by} \quad \gamma = \frac{C_p}{C_v} = \frac{D+2}{D}$$

Where D is the number of degrees of freedom of the gas molecules.

$$U = (D/2)nRT = (D/2)NkT = (D/2)pV$$

D = 3 for monatomic gasses and D = 5 for diatomic gasses.

$$C_p - C_v = R$$

Reflect on the experience you've had so far with today's topic. What sorts of notes might you want to write on a note sheet for the exam (which you can test out by using for the rest of the worksheet and on this week's homework and quiz too)?

2) Circle the appropriate expressions for each type of thermal process. (In the following: $C_p = C_v + R$ and $\gamma = C_p/C_v$.)

Isobaric	$p = \text{constant}$	$W_{by} = nRT \ln(V_f/V_0)$	$Q = nC_v \Delta T$	$\Delta U = Q$
	$T = \text{constant}$	$W_{by} = 0$	$Q = 0$	$\Delta U = Q - W_{by}$
	$pV^\gamma = \text{constant}$	$W_{by} = -\Delta U$	$Q = nC_p \Delta T$	$\Delta U = 0$
	$V = \text{constant}$	$W_{by} = P\Delta V$	$Q = W_{by}$	$\Delta U = -W_{by}$
Adiabatic	$p = \text{constant}$	$W_{by} = nRT \ln(V_f/V_0)$	$Q = nC_v \Delta T$	$\Delta U = Q$
	$T = \text{constant}$	$W_{by} = 0$	$Q = 0$	$\Delta U = Q - W_{by}$
	$pV^\gamma = \text{constant}$	$W_{by} = -\Delta U$	$Q = nC_p \Delta T$	$\Delta U = 0$
	$V = \text{constant}$	$W_{by} = P\Delta V$	$Q = W_{by}$	$\Delta U = -W_{by}$
Isochoric	$p = \text{constant}$	$W_{by} = nRT \ln(V_f/V_0)$	$Q = nC_v \Delta T$	$\Delta U = Q$
	$T = \text{constant}$	$W_{by} = 0$	$Q = 0$	$\Delta U = Q - W_{by}$
	$pV^\gamma = \text{constant}$	$W_{by} = -\Delta U$	$Q = nC_p \Delta T$	$\Delta U = 0$
	$V = \text{constant}$	$W_{by} = P\Delta V$	$Q = W_{by}$	$\Delta U = -W_{by}$

Thermodynamic Processes
 Physics 103 – General Physics

Isothermal	$p = \text{constant}$	$W_{\text{by}} = nRT \ln(V_f/V_0)$	$Q = nC_v \Delta T$	$\Delta U = Q$
	$T = \text{constant}$	$W_{\text{by}} = 0$	$Q = 0$	$\Delta U = Q - W_{\text{by}}$
	$pV^\gamma = \text{constant}$	$W_{\text{by}} = -\Delta U$	$Q = nC_p \Delta T$	$\Delta U = 0$
	$V = \text{constant}$	$W_{\text{by}} = P\Delta V$	$Q = W_{\text{by}}$	$\Delta U = -W_{\text{by}}$

3) Consider the following thermal processes and descriptions of actual physics systems.

A) Match each thermal process with one or more descriptions. Note that not all of the descriptions correspond to a thermal process.

- | | |
|------------|---|
| Isobaric | An ideal gas in a cylinder with a piston (syringe) is compressed very quickly, so that there is no time for the gas and the surrounding air to exchange any heat energy. |
| Isochoric | An ideal gas is enclosed in a metal cylinder that is sealed with a moveable piston that is open to the atmosphere on one side. The cylinder is then cooled by pipes carrying cold water. |
| Isothermal | An ideal gas is enclosed by a cylinder that is sealed with a moveable piston. The cylinder and piston are surrounded by a thick layer of insulation. The piston is pulled so as to increase the volume of the cylinder. |
| Adiabatic | An ideal gas is enclosed in a metal cylinder that is sealed with a moveable piston. The cylinder sits over a flame while the temperature of the cylinder is maintained at 200°C by a thermostat and the piston is slowly pulled outward to increase the volume of the cylinder. |
| Isothermal | An ideal gas is sealed in a metal canister that is placed on top of an electric heater. |
| Adiabatic | An ideal gas is enclosed in a metal cylinder that is sealed with a moveable piston. The cylinder is placed in a very large tub of ice water and the piston is slowly pushed inward to decrease the volume of the cylinder. |

B) Circle the words in each description that give you clues about what kind of process is happening.

4) For this problem, we'll use the pV diagram to the right:

A) Suppose we take 1 mole of an ideal gas from state 1 to state 2 along a straight line (as indicated). What is the work done by the gas in terms of p and V ?

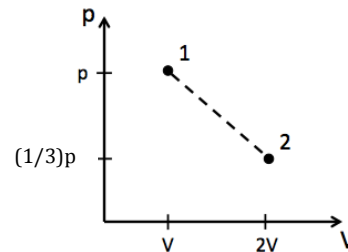

B) Now imagine that we change the pressure and volume of the gas so that it moves from state 2 to state 1 along the same line. Now what is the work done by the gas?

C) If you figured correctly, your answer to A should be positive and your answer to B should be negative. Why? What do these signs mean?

D) Using your calculations above, circle the correct word in each phrase:

When a gas increases in volume, the work done by the gas is *positive / negative*.

When a gas decreases in volume, the work done by the gas is *positive / negative*.

E) You've been told that you can express the change of internal energy of a gas that undergoes some process in which P, V, and/or T are modified as: $\Delta U = Q - W_{by}$. Here, Q is the heat energy added to the gas and W_{by} is the work done by the gas. With this expression in mind, circle the correct word in each phrase:

When W_{by} is *positive / negative* it means you are increasing U of the gas by adding energy to it.

When W_{by} is *positive / negative* it means you are decreasing U of the gas by letting it expend energy on the environment.

F) If you want the gas to do something like push a piston outward, which path should you choose: $1 \rightarrow 2$ or $2 \rightarrow 1$?

5) Consider one mole of ideal gas that is taken through the following cycle. Fill in the boxes:

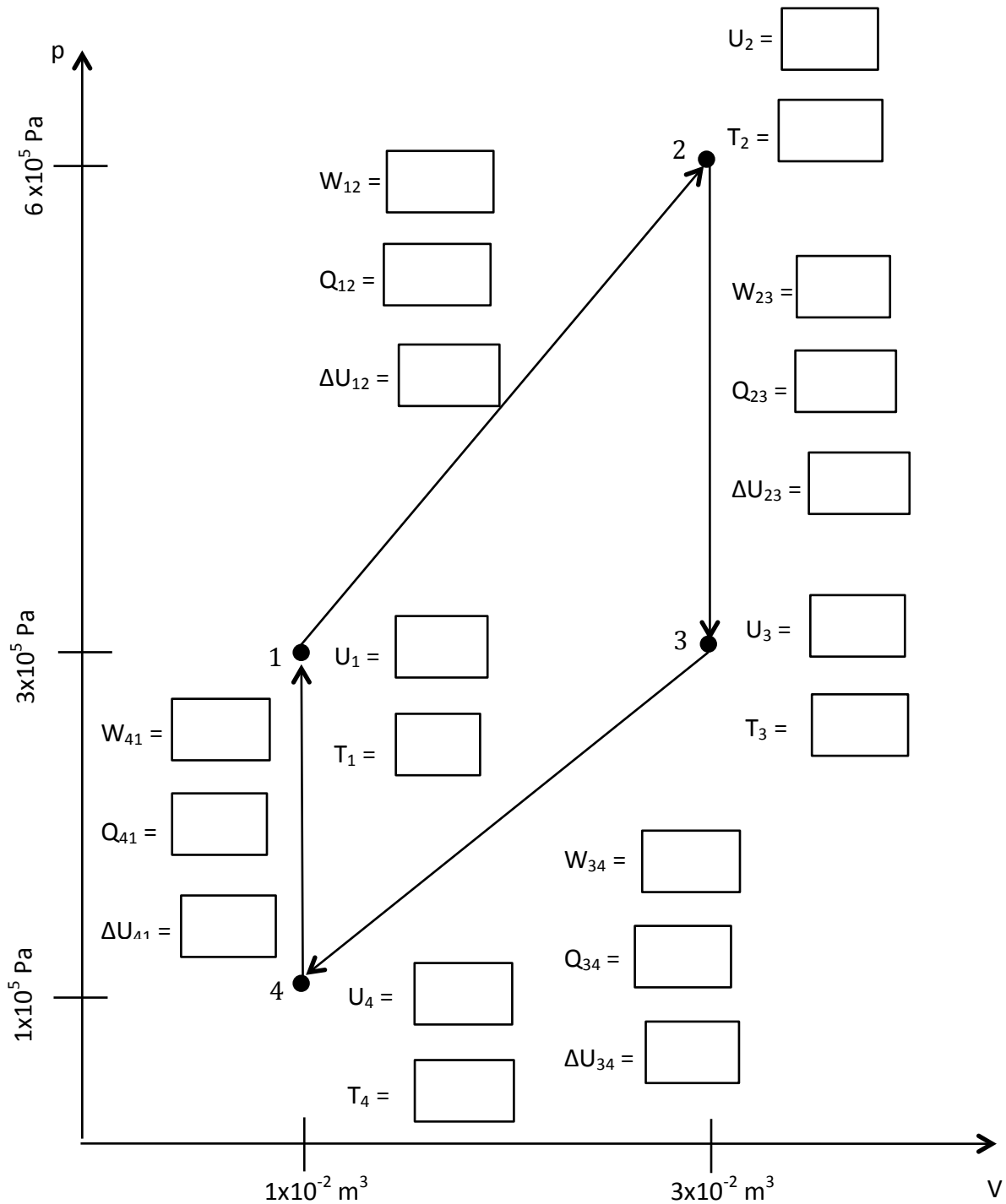

A) The total work done by the gas during this cycle is:

B) The net heat added to the gas during this cycle is:

C) The net change in internal energy during this cycle is:

1) Which thermal process would you chose if...

...you wanted to get the most work out of the gas for the least heat energy added?

- A) Isobaric B) Adiabatic C) Isochoric E) Isothermal

...you wanted the gas to do no work?

- A) Isobaric B) Adiabatic C) Isochoric E) Isothermal

...you wanted the work done by the gas to equal the heat energy you put in?

- A) Isobaric B) Adiabatic C) Isochoric E) Isothermal

...if you wanted some work done, but less than the heat energy you put in?

- A) Isobaric B) Adiabatic C) Isochoric E) Isothermal

2) The efficiency of a car engine is typically about 25%. If you consume a gallon of gas to drive a certain distance and burning a gallon of gasoline releases 1.3×10^8 J of heat energy, how much excess heat does the engine dump to the environment?

- a) 130,000,000 J
- b) 97,500,000 J
- c) 65,000,000 J
- d) 32,500,000 J
- e) 115,000,000 J

3) A Carnot engine uses a hot reservoir at 600 K and a cold reservoir at 300 K. What are the efficiencies of the engine if you increase the hot reservoir by 10% in one case and decrease the cold reservoir by 10% in the other case?

- a) 0.550 if increase T_H and 0.545 if decrease T_C
- b) 0.500 if increase T_H and 0.550 if decrease T_C
- c) 0.550 if increase T_H and 0.500 if decrease T_C
- d) 0.500 if increase T_H and 0.500 if decrease T_C
- e) 0.545 if increase T_H and 0.550 if decrease T_C

Useful Expressions:

$$\Delta U = Q - W_{\text{by}} \quad e = \frac{W_{\text{by}}}{Q_H} = \frac{Q_H - |Q_C|}{Q_H} = 1 - \frac{|Q_C|}{Q_H}$$

$$W_{\text{by}} = Q_H + Q_C \quad (Q_C < 0) \quad e = \frac{T_H - T_C}{T_H} = 1 - \frac{T_C}{T_H} \quad \text{for Carnot Cycle only}$$

Reflect on the experience you've had so far with today's topic. What sorts of notes might you want to write on a note sheet for the exam (which you can test out by using for the rest of the worksheet and on this week's homework and quiz too)?

4) Originally, most of thermodynamics was created during the 1800s in order to understand the working of steam engines. There are also a few examples of heat engines in the non-technological world. Biological organisms are not really heat engines, but the heat engine concept is a fairly good approximation to the way hurricanes work.

A) Identify the appropriate thermal process for each stage of airflow in a hurricane:

First Phase: Air flows into the low-pressure eye of the hurricane, expanding in volume as it goes. As it moves, it's in thermal equilibrium with the ocean, which acts like a huge heat reservoir at a typical temperature of 27° C.

Isobaric / Adiabatic / Isovolumetric / Isothermal

Second Phase: The air ascends in the storm's eye very quickly, much too quickly for any heat energy to be added to or extracted from it.

Isobaric / Adiabatic / Isovolumetric / Isothermal

Heat Engines
 Physics 103 – General Physics

Third Phase: At the upper layer of the storm, the air is carried away into other weather systems, contracting in volume as it enters higher pressure. In this case, the surrounding air mass at such great altitude keeps the air flowing out of the hurricane at a constant temperature of around -73°C .

Isobaric / Adiabatic / Isovolumetric / Isothermal

Fourth Phase: Once it's beyond the edge of the storm, the air descends rapidly. Once again, this process happens so quickly, that no heat energy is exchanged with the surroundings.

Isobaric / Adiabatic / Isovolumetric / Isothermal

B) If you've chosen the sequence of thermal processes correctly, it should look awfully familiar. In fact, this cycle has a name. What is it?

C) What are the signs of the change in internal energy of the air, the heat added to the air, and the work done on the air during each phase?

	First Phase	Second Phase	Third Phase	Fourth Phase
ΔU				
Q				
$W_{\text{by air}}$				

D) Compare the magnitude of the change in internal energy of the air during the second phase and to the change in internal energy of the air during the fourth phase. No need for calculations here – just make a qualitative assessment. Are they the same? If not, which is larger?

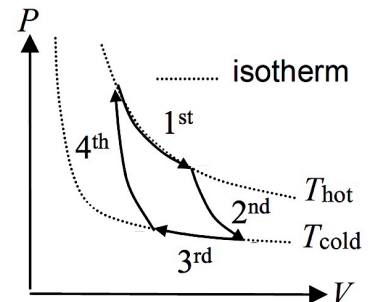

Heat Engines
Physics 103 – General Physics

E) Compare the magnitude of the work done by the air during the first phase and to the work done by the air during the third phase. No need for calculations here – just make a qualitative assessment. Are they the same? If not, which is larger?

F) What is the efficiency of the hurricane modeled above? (Hint: Be sure to decide the correct units for temperature.)

G) What would the efficiency be if the hot reservoir (the surface of the ocean) were 3°C hotter?

H) What would the efficiency be if the cold reservoir (the cloud tops) were 3° colder?

I) Which of these two reservoir temperatures is the efficiency of the storm more sensitive to?

5) Consider the thermodynamic cycle of one mole of a monatomic ideal gas below. The processes from 1 to 2 and 3 to 4 are isobaric. The process from 2 to 3 is adiabatic and the process from 4 to 1 is isothermal.

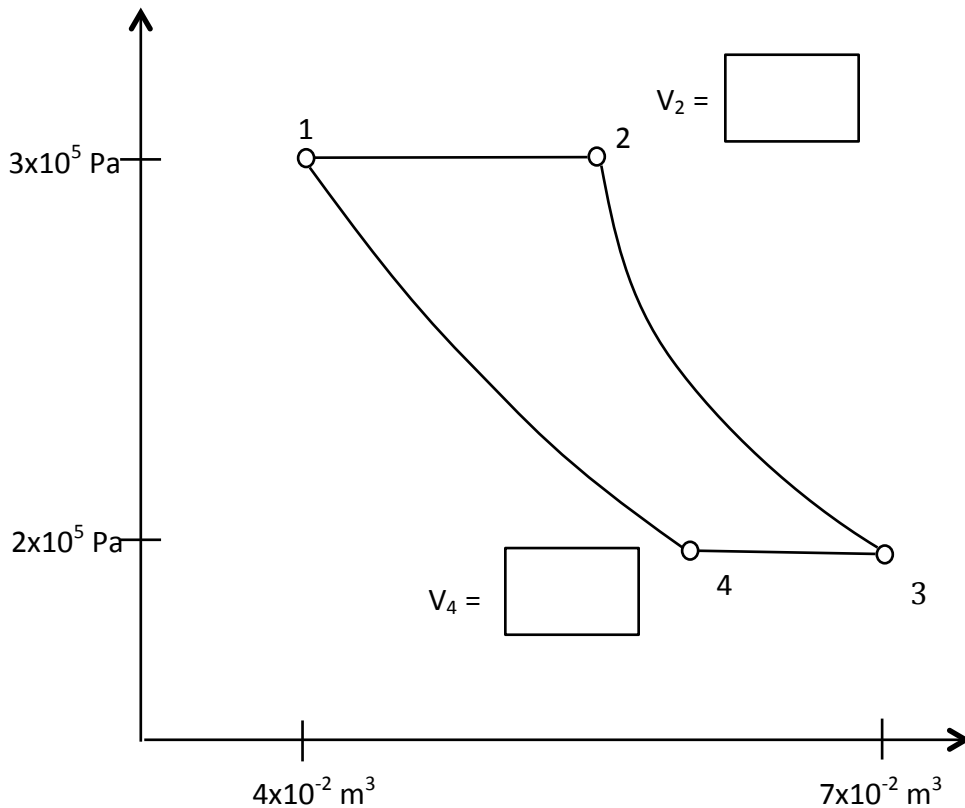

A) Given what you know about thermal processes, fill in the two empty boxes on the PV diagram. (Hint: Since you know P and V at point 3, what can you say about their relationship at point 2? Likewise, since you know P and V , and can calculate T , at point 1, what do you know about point 4?)

B) In general a heat engine works like this: Heat energy is added (given by Q_H or the sum of all the positive Q 's during the cycle). A portion of this heat energy is converted into work (W_{by} or the sum of *all* the work, positive and negative, done during the cycle) and a portion continues on to be released as heat energy that leaves the system (Q_C or the sum of all the negative Q 's during the cycle).

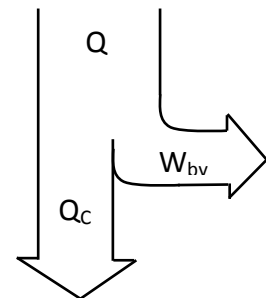

Heat Engines
Physics 103 – General Physics

To find the efficiency of the engine depicted above, what is the total work done over the whole cycle?

C) What is the heat added to the engine during the cycle (that is, the sum of all positive Q 's)?

D) What is the heat that leaves the engine during the cycle (that is, the sum of all negative Q 's)?

E) With all that information, we can compute the efficiency of the engine. What is it?

Refrigerators and Entropy – Group Sheet
Physics 103 – General Physics

Your group member names:

1) Which of the following is a more disorderly system:

- a) A cup full of ice chips
- b) A cup full of water

Justify your choice below:

2) Summer is coming up. Imagine you are hanging out with some friends on the terrace and one of them asks you (as I guarantee will happen) what the Second Law of Thermodynamics is all about and why it's so important. How would you answer?

Useful Expressions:

$$CP = |Q_C|/|W| = \frac{|Q_C|}{|Q_H| - |Q_C|} \quad \text{For Carnot refrigerator } CP = \frac{|T_C|}{|T_H| - |T_C|} \quad \Delta S = \frac{Q}{T}$$

Reflect on the experience you've had so far with today's topic. What sorts of notes might you want to write on a note sheet for the exam (which you can test out by using for the rest of the worksheet and on this week's homework and quiz too)?

3) One of the many depressing conclusions we can draw from the Second Law of Thermodynamics is that as entropy increases in the universe as a whole, less and less energy can be used to do work. This is the essence of the heat death of the universe – at some point everything will stop because there is no more energy available to do useful work. To see this, let's compare two different cases.

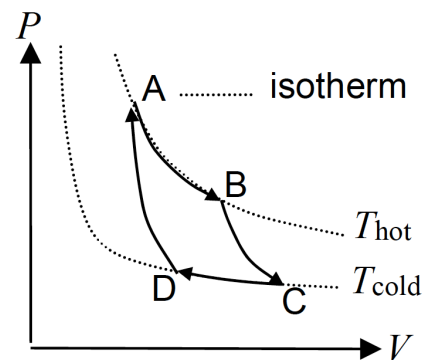

A) Calculate the work output of a Carnot Engine that draws 4000 J of energy from a 600 K hot thermal reservoir and dumps unused energy into a cold thermal reservoir at 100 K.

B) What is the increase in entropy associated with one cycle of this Carnot Engine? You may already remember the answer, but try the calculation to confirm. Also recall that $Q = 0$ for the two adiabatic processes, so the only change in entropy is in the isothermal processes.

Refrigerators and Entropy
Physics 103 – General Physics

C) Now imagine that the 4000 J drawn from the 600 K reservoir first flows into a 250 K reservoir. Then it flows from the 250 K reservoir into the Carnot Engine, which produces work and dumps unused energy into a cold thermal reservoir at 100 K. What is the work output of this engine?

D) Calculate the increase in entropy in the case of this second process. You will need to include both the processes occurring in the engine and the initial transfer of heat energy from the 600 K reservoir to the 250 K reservoir.

E) Assume that the 4000 J of work moves direction from the 600 K reservoir to the 100 K reservoir with no work done. What is the increase in entropy in this case?

F) Do your findings support the conclusion that greater changes in entropy indicate greater amounts of heat energy unavailable for work?

The following questions review some of the core concepts from earlier in the course.

4) Imagine someone holding a gallon of milk in an outstretched arm. The extended free body diagram of the arm looks like this:

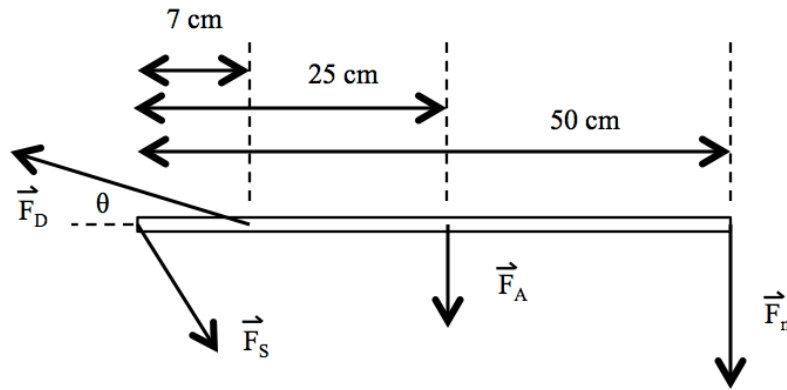

F_D is the force exerted by the deltoid muscle on the upper arm at an angle of $\theta = 12^\circ$. F_A is the weight of the arm, which is 30 N. F_M is the weight of the milk, which is 80 N. F_S is the force exerted at the shoulder joint.

What is the force exerted by the deltoid muscle, F_D ?

6) Non-viscous fluid ($\rho = 2400 \text{ kg/m}^3$) is flowing the pipe shown.

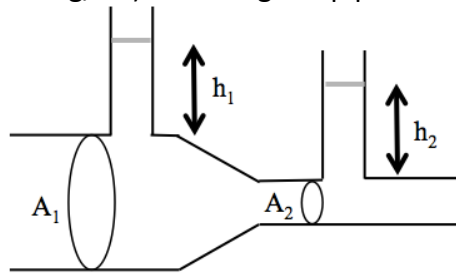

The area of the pipe below the first vertical column is $A_1 = 10 \text{ cm}^2$. The area of the pipe below the second vertical column is $A_2 = 2 \text{ cm}^2$. Assume both columns are open to the atmosphere ($P_{\text{atm}} = 100 \text{ kPa}$).

A) Which is larger: h_1 or h_2 ?

B) If the fluid is moving through A_1 with a velocity of 2 m/s and at a pressure of 300 kPa , what are the heights of the water in the columns, h_1 and h_2 ?

7) A sound wave with wavelength of 2 m in the air enters the water.

A) If the speed of sound in air is 343 m/s and the speed of sound in water is 1484 m/s , how does the frequency of the sound change as it moves from sound to air?

B) If the speed of sound in air is 343 m/s and the speed of sound in water is 1484 m/s , how does the wavelength of the sound change as it moves from sound to air?