

Introduction and Electric Charge

Welcome to Physics 104!

Today your TA will give you some basic information about how discussion section will work this semester.

Discussion worksheets have two parts:

- *Group Questions*, which are generally shorter conceptual questions to serve as a warm-up. These are to get you thinking about some of the main ideas that will be expanded on later in the activity.
- *Exercises*, which are longer questions to give you practice with the types of extended problem solving that you will be encountering on homework and exams. It's OK if you don't finish all the exercises before the end of your discussion section—any remaining questions can serve as additional practice.

You do not need to turn in your discussion work for grading. Discussion solutions are posted on the Canvas weekly pages and unlock after all the day's discussions have ended. Complete the discussion activity to the best of your ability and check your responses after class.

Group Questions

1. The picture to the right shows the excess charge distribution on a neutral electroscope when a charged rod is brought near it. What is the sign of the excess charge on the rod?

- Positive
- Negative
- It has no charge
- It depends on the atmospheric conditions
- Cannot tell from the given information

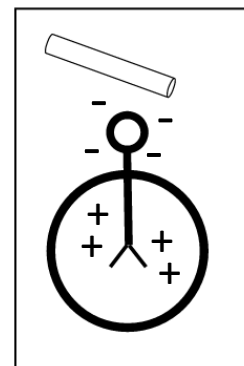

2. You have a glass rod that has been rubbed with silk, and a small neutrally charged aluminum foil ball attached to a thread. Describe what happens when you slowly approach the ball with the rod.
- The ball does not respond to the rod.
 - The ball is always repelled by the rod.
 - The ball is initially attracted to the rod and is still attracted after they touch.
 - The ball is initially attracted to the rod and then no longer responds after they touch.
 - The ball is initially attracted to the rod and then is repelled after they touch.

In most discussion exercises, we will include a summary of the most important equations and mathematical expressions related to the current topic. (There are none for today.) But you may use this space to keep additional notes for yourself, and we will include extra space on later activities for you to add your own notes and reminders.

Exercises

3. Glass tends to acquire a positive charge when rubbed with silk. Based on this information, sketch a picture of the final excess charge distributions on the glass rod and the aluminum foil ball from question 2.

4. You may have experienced or observed that after rubbing a balloon on your hair, individual hair strands tend to be attracted to the balloon.
 - A. Explain the attraction between the strands of hair and the balloon. Draw a picture if needed.



Credit: Exploratorium Teacher Institute

B. The Triboelectric Series describes how materials tend to exchange electric charge upon being rubbed together. Use the table at right to decide the final charge on the balloon and the hair.

Balloon: + or -

Hair: + or -

C. Is your response to part B consistent with what you know about how like and opposite charges respond to one another?

D. After being rubbed on a person's hair, a balloon is observed to attract small bits of paper. Explain how this can be possible.

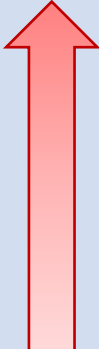
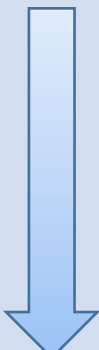
Material	When rubbed
Human hair, oily skin	More likely to give up electrons 
Nylon, dry skin	
Glass	
Acrylic, Lucite	
Leather	
Rabbit fur	
Quartz	
Mica	
Silk	
Aluminum	
Paper	
Cotton	
Wool	
Steel	
Wood	
Amber	 More likely to accept electrons
Rubber balloon	
Hard rubber	
Nickel, copper	
Brass, silver	
Gold, platinum	
Acetate, rayon	
Polystyrene	
Polyester	
Plastic wrap	
Polyurethane	
Vinyl, PVC	
Teflon	
Ebonite	

5. Two spheres are illustrated below. One is made of an insulating material and the other is made of a conducting material. Suppose that equal amounts of excess negative charge are deposited on the left side of the two spheres (where the arrow is pointing). Sketch how you would expect the excess charge distributions to differ between the two. Explain.

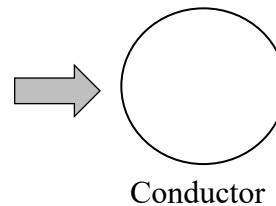
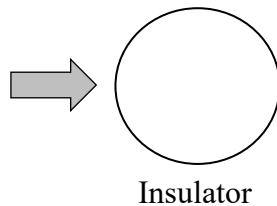

6. In the situations below, predict what excess charge will result on the conducting sphere.

- A. Metal sphere A is initially neutral. A positively charged rod is brought near, but not touching. Is sphere A now *positive*, *negative*, or *neutral*? Explain.

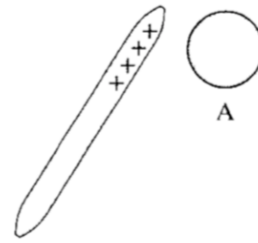

- B. Metal spheres A and B are initially neutral and are touching. A positively charged rod is brought near A, but not touching. Is sphere A now *positive*, *negative*, or *neutral*? Explain.

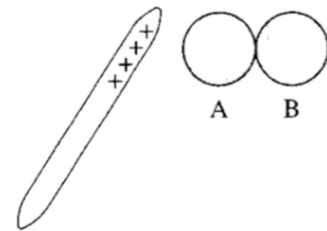

- C. Metal sphere A is initially neutral. It is connected by a metal wire to the ground. A positively charged rod is brought near, but not touching. Is sphere A now *positive*, *negative*, or *neutral*?

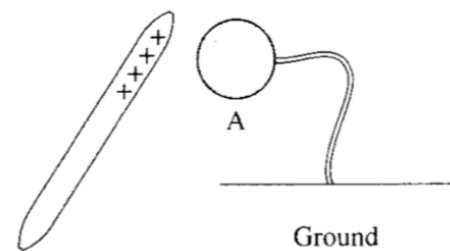

Coulomb's Law

Group Questions

1. Two charged objects are a certain distance apart. If you double the charge on one of them and double the distance that separates them, what happens to the Coulomb force between them?
- It is unchanged.
 - It is a quarter of what it was.
 - It is twice what it was.
 - It is four times what it was.
 - It is half of what it was.

2. Four charges are arranged as shown at right. If the total Coulomb force on Q_A is zero, what is the sign of the charge on Q_D ?

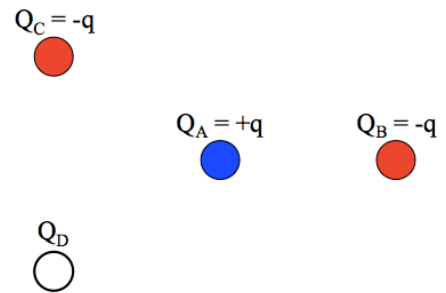

- Positive
 - Negative
 - Could be positive or negative
3. Which of the following best explains how a gecko can climb smooth surfaces such as glass?
- Gecko foot pads have a net positive charge, so they stick to walls in the same way a rubbed balloon will.
 - As they move, geckos remove electrons from neutral surfaces through the triboelectric effect.
 - Geckos can generate electric fields that pull them toward surfaces or even allow them to hang from ceilings.
 - Molecular dipoles within gecko foot pads attract other molecular dipoles within surfaces.

Coulomb's Law

Useful expressions

$$|\vec{F}_e| = k \frac{|q_1||q_2|}{r^2}$$

$$k = 9 \times 10^9 \text{ N} \cdot \text{m}^2/\text{C}^2$$

Exercises

4. The net Coulomb force on a charge is the vector sum of all the Coulomb forces acting on it.

A. On the figure below, select the point(s) where a proton would experience zero net force.

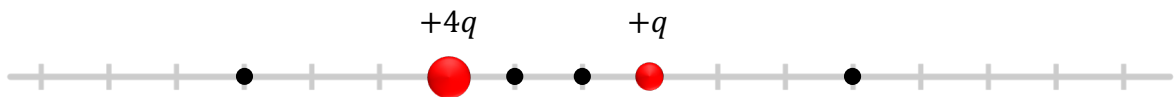

B. Would the force on an electron at this point be to the left, to the right, or zero?

C. On the figure below, select the point(s) where an electron would experience zero net force.

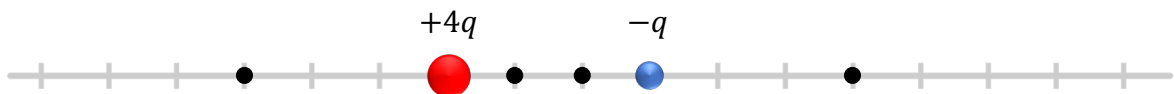

Coulomb's Law

5. So far in class we have examined the force exerted by a dipole. Now what about the force exerted on a dipole?

Let's model a dipole as a negative (q_A) and a positive (q_B) charge linked by a solid bar of length $2L$ that won't stretch or compress. There is a nearby negative charge (q_C) that is a distance d above the midpoint of the bar. Assume all the charges in the picture have the same magnitude of charge, q .

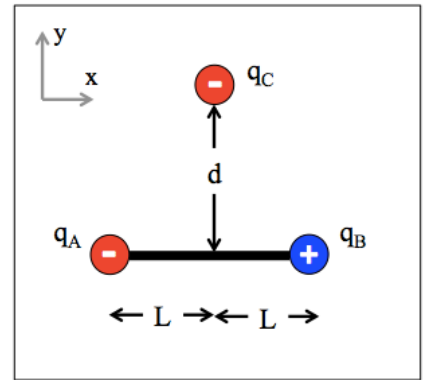

- A. Start by making a prediction. What do you think will happen to the dipole because of the force exerted by the negative charge? Will it move? If so, how?
- B. Using the values to the right, determine the magnitude F_{CA} of the Coulomb force that q_C exerts on q_A .

$$\begin{aligned} q_A &= 10 \text{ nC} \\ q_B &= 10 \text{ nC} \\ q_C &= 10 \text{ nC} \\ L &= 300 \text{ } \mu\text{m} \\ d &= 400 \text{ } \mu\text{m} \end{aligned}$$

- C. Sketch the vector \vec{F}_{CA} . Use your drawing to determine its x - and y -components.

$$F_{CA,x} =$$

$$F_{CA,y} =$$

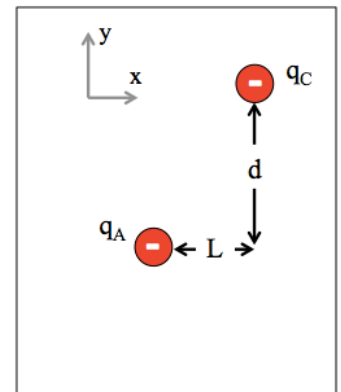

- D. Determine the magnitude F_{CB} of the Coulomb force that q_C exerts on q_B .

Coulomb's Law

- E. Sketch the vector \vec{F}_{CB} . Use your drawing to determine its x - and y -components.

$$F_{CB,x} =$$

$$F_{CB,y} =$$

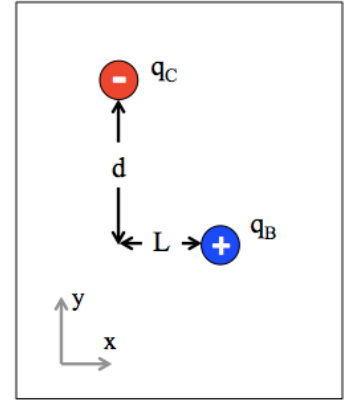

- F. Use the components you found above to determine the components of the net force on the dipole. What is the magnitude of the net force on the dipole?

$$F_{net,x} =$$

$$F_{net,y} =$$

$$|F_{net}| =$$

- G. Describe the linear motion of the dipole. Will it accelerate? If so, in what direction?

- H. Will the dipole experience any *other* kind of motion? Can you describe what sort of motion this will be? (*Hint*: Draw an extended free body diagram of the dipole.)

- I. How would the motion of the dipole be different if you flipped the negative charge over, so it was underneath the dipole?

Coulomb's Law

6. Consider two carbon monoxide molecules that are near each other as shown. Assuming that all the charges are $2e$ (where e is the fundamental charge), L is 2 nm, and d is 50 nm, what force do the dipoles exert on each other? Indicate both magnitude and direction.

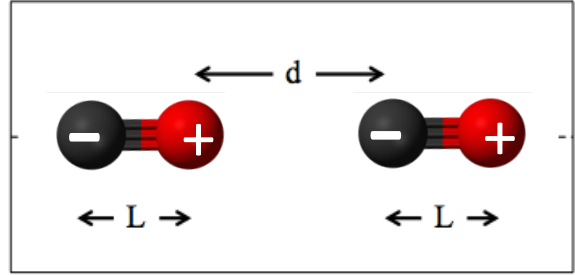

Vectors Review

Like all forces, the Coulomb force is represented by a vector. As with other vector quantities we'll be encountering in this course, you'll need to draw on your vector knowledge when working with it. Here is a review of some basic vector operations.

There are two methods of adding vectors:

- The tip-to-tail method (or the graphical method)
- The component method

To use the first method, imagine each vector as an instruction. Vector A, which has a magnitude of 10 units and is directed 45° counterclockwise from the positive-x axis is something like "take 10 steps in a northeast direction."

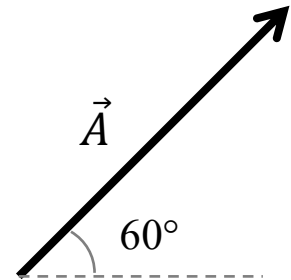
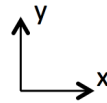

Vector B has a magnitude of 5 units and is directed along the negative-x axis and is something like "take 5 steps to the west." Adding a second vector A to B is just stringing the two instructions they give together sequentially. Note that whether you start with A and then B, you get to the same spot you would have reached if you'd started with B and then A.

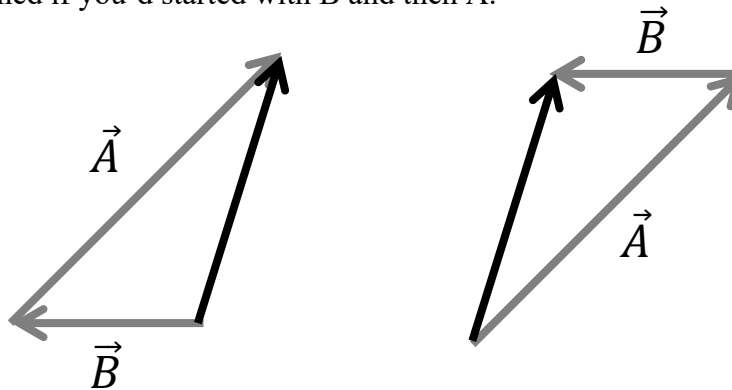
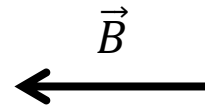

The other way to do vector math involves decomposing vectors into components. In this case, you use trig functions to find the x and y components that make up the vector and then add (or subtract) all the x and all the y components separately.

If we go back to vector A, then the x component of A would be the length of A times $\cos(60^\circ)$ and the y component of A would be the length of A times $\sin(60^\circ)$.

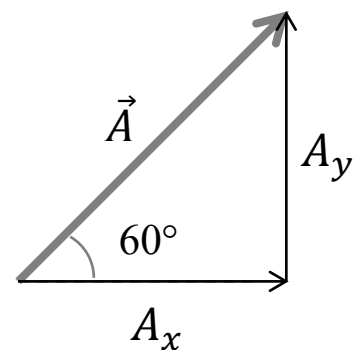

Electric Fields and Potential Energy

Group Questions

1. A $+5 \mu\text{C}$ test charge experiences an electric force with a magnitude of $1.25 \times 10^{-3} \text{ N}$ when placed at a certain location. What magnitude of force would a $-10 \mu\text{C}$ test charge experience at the same location?

- a) 125 N
- b) 250 N
- c) $1.25 \times 10^{-3} \text{ N}$
- d) $2.5 \times 10^{-3} \text{ N}$
- e) $5 \times 10^{-6} \text{ N}$

2. Electric field lines are drawn for four charged objects below. Which object has the greatest amount of excess positive charge?

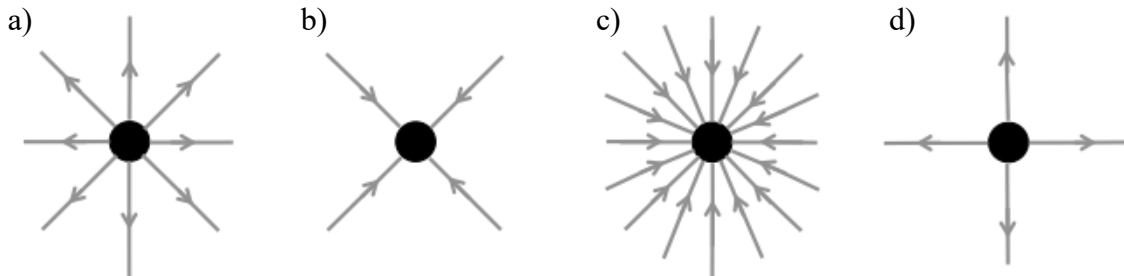

3. A positively charged particle moves in a uniform electric field as shown. Does the electric potential energy of the charge *increase*, *decrease*, or *stay the same*?

- a) Increase
- b) Decrease
- c) Stay the same
- d) It depends on the strength of the E-field, E
- e) It depends on the magnitude of the charge, q

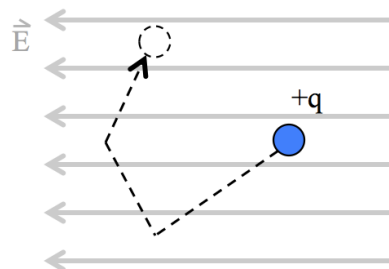

Useful expressions

$$\vec{F} = q\vec{E}$$

$$|\vec{E}| = k \frac{|q|}{r^2}$$

$$U_{elec} = k \frac{q_1 q_2}{r}$$

$$\Delta U = -qE \quad (\text{for a constant E-field})$$

Exercises

4. Consider the pair of charges shown below:

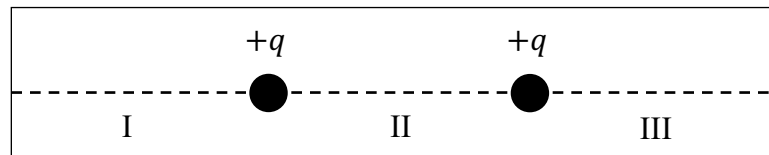

- A. What is the direction of the electric field due to both charges for points on the dotted line in region I?

- B. What is the direction of the electric field due to both charges for points on the dotted line in region III?

- C. Is there a place in region II on the dotted line where the electric field due to both charges is equal to zero? If so, mark it on the figure with an X.

Electric Fields and Potential Energy

5. Consider three charges arranged as shown to the right.

A. Draw vectors indicating the direction of the electric field at point P due to each individual charge.

B. Find the magnitude of the net electric field at point P in terms of k , q , and d . (Remember to add the field contributions as vectors.)

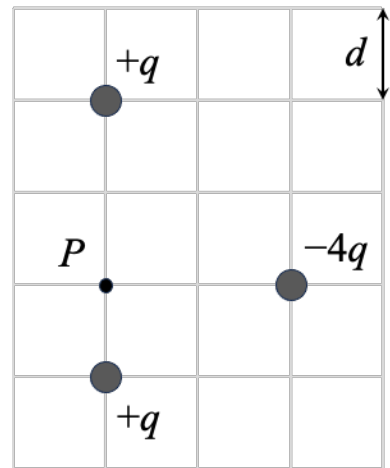

C. If $q = 10 \mu\text{C}$ and $d = 10 \text{ cm}$, what is the magnitude of the electric field at point P ?

D. What force will a $+1 \mu\text{C}$ charge experience at point P ? What about a $-10 \mu\text{C}$ charge?

Electric Fields and Potential Energy

6. The strength of the average electric field inside a cell membrane is 5×10^6 N/C. The outside of the cell has a net positive charge. The inside of the cell has a net negative charge. The width of the average cell membrane is 10 nm.

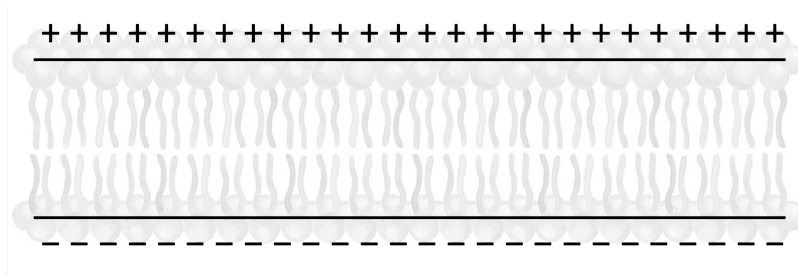

- A. Draw the electric field lines on the diagram above. You may assume the cell membrane extends very far to the right and left of the figure.
- B. An ion gate in the cell membrane expels a sodium ion (which has a net charge of $+e$, where e is the fundamental charge of 1.6×10^{-19} C). Is the work done by the gate *positive* or *negative*?
- C. What is the magnitude of the work that the cell membrane does to eject the sodium ion? (Assume the electric field inside the cell is uniform.)

7. Two electrons are initially held 1 cm apart as shown, and then released.

- A. What is the initial electric potential energy of the system of two electrons?

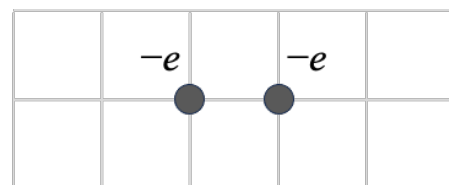

- B. What is the electric potential energy at a later time when the electrons are 3 cm apart?

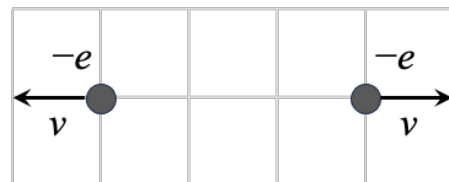

C. What is the speed of each electron when they are 3 cm apart? The mass of a single electron is $m_e = 9.1 \times 10^{-31}$ kg. (*Hint: Apply conservation of energy.*)

D. What is the greatest speed each electron will reach?

8. What is the total electric potential energy of the system of charges at right? What is the meaning of your result?

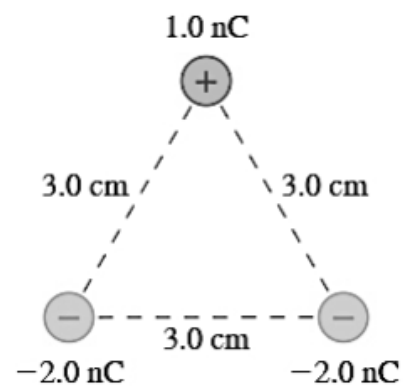

Electric Potential

Group Questions

1. A positively charged particle moves in a constant electric field as shown. Does the electric potential energy of the charge *increase, decrease, or stay the same*?

- a) Increase
- b) Decrease
- c) Stay the same
- d) It depends on the strength of the E-field, E
- e) It depends on the magnitude of the charge, q

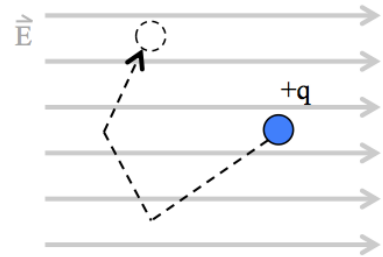

2. In the above example, does the particle move through a potential difference?

- a) Yes, it moves to a higher electric potential
- b) Yes, it moves to a lower electric potential
- c) No, it does not move through a potential difference
- d) It depends on the strength of the E-field, E
- e) It depends on the magnitude of the charge, q

3. In the above diagram, draw the equipotential surfaces (in this case lines) for this electric field. Is this consistent with your answer to question 2?

Electric Potential

Useful expressions

$$\vec{F} = q\vec{E}$$

$$|\vec{E}| = k \frac{|q|}{r^2}$$

$$U_{elec} = k \frac{q_1 q_2}{r}$$

$$\Delta U = -qEd \cos \theta \quad (\text{for a constant E-field})$$

Exercises

4. The region pictured at right contains a uniform electric field (that is, the field is the same everywhere). The field lines are drawn. Points 1 through 5 form a square that's 8 cm on each side. Point 3 is in the center of the square.

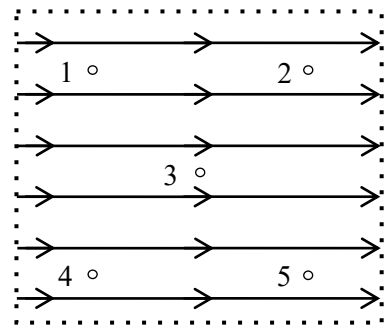

- A. If an object with a charge of $+10 \mu\text{C}$ is placed at point 1, in which direction will it move?

- B. The $+10 \mu\text{C}$ object starts at rest at point 1. By the time it reaches point 2, its kinetic energy is $2.4 \times 10^{-4} \text{ J}$. What was the object's change in electric potential energy?

- C. What is the electric potential difference between points 1 and 2?

- D. What is the electric potential difference between points 1 and 4?

E. Given your answer to part C, what is the electric potential difference between points 1 and 3?

F. What is the magnitude of the electric field in this region?

G. How much work would you need to do to move a $-10 \mu\text{C}$ charge from 1 to 5? Make sure to specify whether the work is positive or negative.

5. Gel electrophoresis is an analysis technique used to identify DNA. Although we can't model the full process with the tools we've developed so far, largely due to the complexity of how the molecular fragments "drift" down through the gel, we can apply some of what we know about electrostatics to understand this technique.

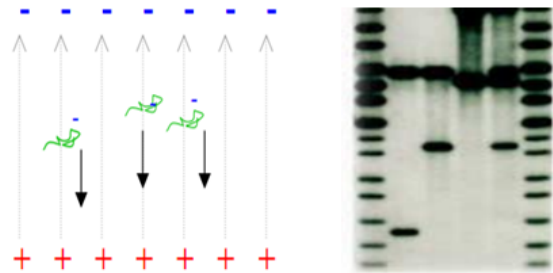

A. Let's say you're working with a gel that's 10 cm long, and the voltage you've applied is 100 V. Assuming the electric field in the gel is uniform, what is its magnitude? (Ignore any effects that the gel itself might have on the field.)

B. You put the DNA fragments you're working with at the top of the gel and turn on the voltage. After an hour, the fragments that are 3000 base pairs long have made it 8 cm along the gel. How much work did the electric field have to do to get them there? (Each base pair has a negative charge of $-3e$.)

- C. What potential difference did the 3000 base pair fragments pass through in their 8 cm trip?
- D. Why do researchers use an electric field in this process? Why not just tilt the gel and allow gravity to pull the DNA fragments down? (Use at least one calculation to justify your answer. It might help you to know that a base pair has a mass of about 1.1×10^{-24} kg.)
6. Two particles each have the same mass, m . However, the first particle has a charge of $4q$ while the second particle has a charge of only q .
- A. The first particle is accelerated from rest through a potential difference of ΔV . What is its final speed, v_1 ? Write an equation for v_1 in terms of m , q , and ΔV .
- B. The second particle is also accelerated from rest through a potential difference of ΔV . What is its final speed, v_2 ? Again, write an equation for v_2 in terms of m , q , and ΔV .
- C. How much larger or smaller is v_2 than v_1 ?
- D. Did the electric field do more work on the first particle or the second particle?

Electric Potential

7. The next few questions involve the charge configuration shown at right. The charges shown are located at the vertices of an equilateral triangle, and are equidistant from point P.

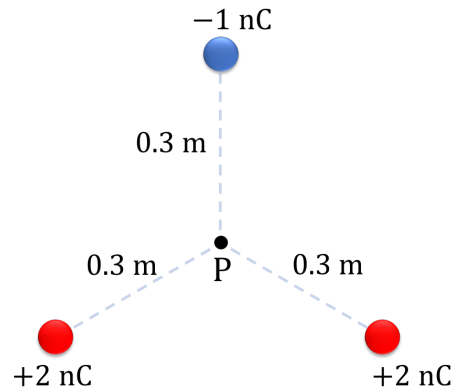

- A. What is the magnitude and direction of the electric field at point P?

- B. What is the electric potential at P, assuming $V = 0$ at infinity?

- C. Say you brought a fourth charge with $Q = +5 \text{ nC}$ in from very far away (essentially infinitely far) to point P. How much potential energy would it gain or lose in the process?

- D. How much work would you need to do to bring the charge Q from infinitely far away to point P?

- E. On the diagram, use an X to mark the approximate location of at least one point where the electric potential is zero. Can you find more than one?

Capacitance

Group Questions

1. Consider a capacitor with a capacitance of $50\ \mu\text{F}$. In one case, this capacitor is connected to a $10\ \text{V}$ battery. In the other case, the capacitor is fully charged and then disconnected from a battery. Suppose we now increase the separation between the plates of each capacitor by an equal amount. Answer the following for each case.

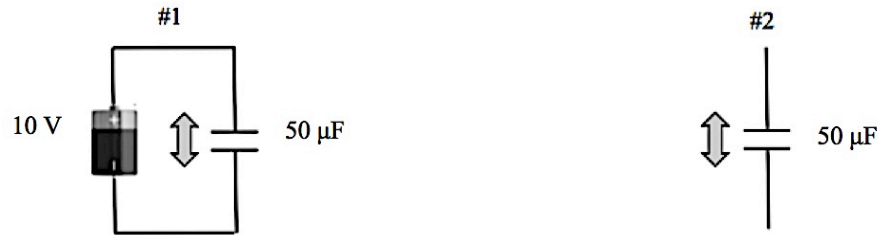

- A. Circle the parameter ($\Delta V =$ the voltage difference between the plates and $q =$ the charge on the plates) that remains constant as we move the plates apart:

ΔV	q		ΔV	q
------------	-----	--	------------	-----

- B. What happens to the electric field between the plates? (*Hint:* Remember $\Delta V = Ed$ for a uniform E-field and $E = \frac{q}{A\epsilon_0}$ in a capacitor.)

Increases	Decreases	Same		Increases	Decreases	Same
-----------	-----------	------	--	-----------	-----------	------

- C. What happens to the capacitance of each capacitor?

Increases	Decreases	Same		Increases	Decreases	Same
-----------	-----------	------	--	-----------	-----------	------

- D. What happens to the parameter (ΔV or q) that doesn't remain constant?

Increases	Decreases	Same		Increases	Decreases	Same
-----------	-----------	------	--	-----------	-----------	------

- E. What happens to the energy stored in each capacitor?

Increases	Decreases	Same		Increases	Decreases	Same
-----------	-----------	------	--	-----------	-----------	------

- F. What happens to the capacitance if a dielectric slab is inserted between the plates?

Increases	Decreases	Same		Increases	Decreases	Same
-----------	-----------	------	--	-----------	-----------	------

Useful expressions

$$C = \frac{q}{\Delta V}$$

$$C = \frac{\epsilon_0 A}{d}$$

$$C = \kappa C_0$$

$$E = \frac{\sigma}{\epsilon_0}$$

$$\sigma = \frac{q}{A}$$

$$U = \frac{1}{2} q \Delta V = \frac{1}{2} C (\Delta V)^2 = \frac{1}{2} \frac{q^2}{C}$$

Exercises

2. Two parallel-plate capacitors, A and B, are connected to batteries of the same voltage (10 V) as shown at right.

- A. Assuming that the negative plate is at -5 V and the positive plate is at $+5\text{ V}$, draw the equipotential lines for -3 V , -1 V , $+1\text{ V}$, and $+3\text{ V}$ between the two plates of each capacitor.

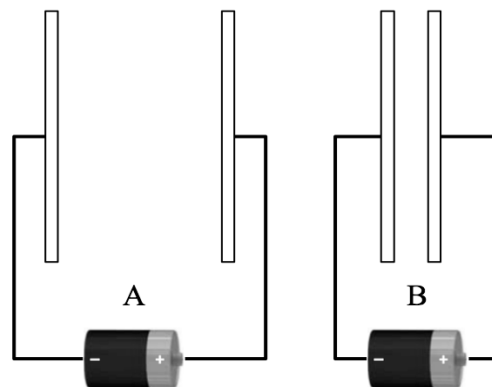

- B. Use your drawing to explain why the electric field between the plates is larger for capacitor B than for capacitor A.
- C. Remember that the strength of the electric field is directly proportional to the charges on the two plates. Use this to explain which pair of plates contains more charge.
- D. Using your answer to C, explain which capacitor has the greater capacitance and why.

E. Suppose the plates were initially in position A and you moved them to position B. Does the electric potential energy stored by the plates *increase* or *decrease*?

F. Does charge flow as you do this?

3. Below is a cell membrane made of lipid molecules which together act as a dielectric in between the charges (ions) gathered outside and inside the cell. Outside there are excess positive ions and inside are excess negative ions which attract each other across the membrane and accumulate in equal numbers on either side. In response, the lipid molecules become polarized as shown.

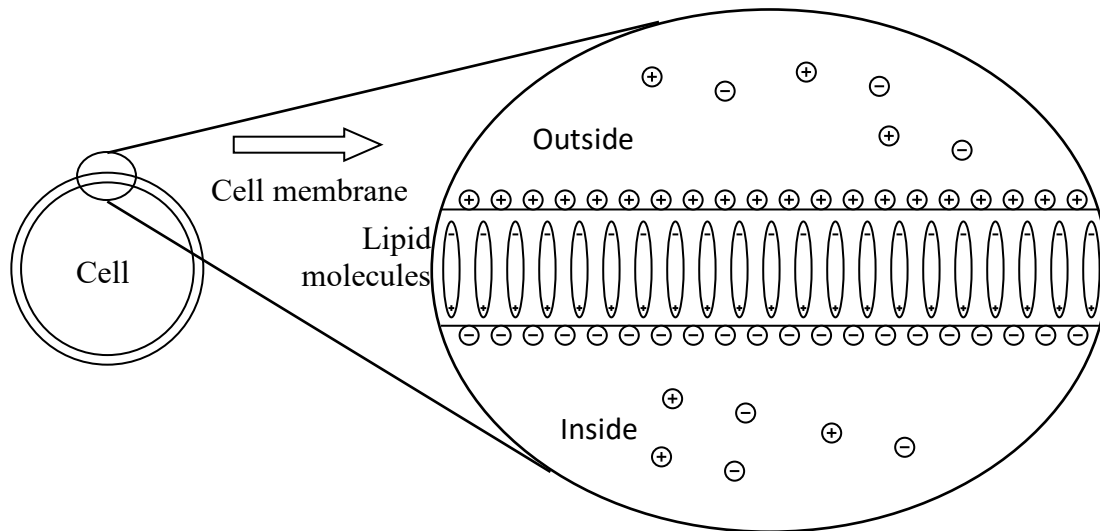

A. Explain in your own words why we're justified in calling the cell membrane a capacitor?
(Hint: What about the cell membrane resembles a capacitor?)

B. If the thickness of the membrane is 10 nm, what is the magnitude and direction of the net electric field in the cell membrane when there is a 70 mV potential difference across the membrane?

Capacitance

- C. What is the magnitude and direction of the E field in the cell membrane due only to the accumulated charge?
- D. What is the magnitude and direction of the E field in the cell membrane due only to the polarized lipid molecules? The dielectric constant for a typical cell membrane is $\kappa = 5$.
- E. The capacitance of cell membranes has been measured to be 10^{-2} F per square meter of surface area. For a single cell with a surface area of 5×10^{-9} m² (a typical size for a mammalian cell), what is the total capacitance of the cell's membrane?
- F. At its resting potential (that is, a 70 mV potential difference across the membrane), how much charge is accumulated on either side of the membrane?
- G. How much electrical potential energy is stored across the cell's membrane?
- H. If the total number of cells in a human being is, on average, 37×10^{12} , how much electrical potential energy is stored in all the cells in your body?

Capacitance

4. Consider the arrangement of two capacitors, A and B, connected to a voltage source below. Note that both pictures are completely equivalent.

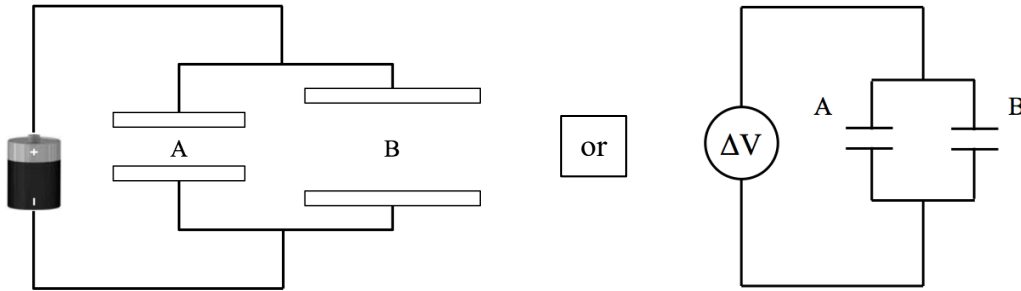

What could you be asked to find about this arrangement? Fill out as many of the lines as you can below. One has been finished for you as an example.

Given these quantities...	...what could you be asked to find?
The capacitance of A, the capacitance of B, and the charge on A.	- ΔV - The charge on B
The capacitance of A, the distance between A's plates, and ΔV .	
The capacitance of B, the distance between A's plates, the charge on A, the charge on B.	
The energy stored in A, ΔV , and the charge on B.	
The distance between A's plates, the distance between B's plates, the area of A's plates, the area of B's plates, the magnitude of the E-field in B.	
The energy stored in A and the energy stored in B.	

Current, Voltage, and Resistance

Group Questions

1. Suppose you are observing a section of hollow tube. Over a 10 second interval, a total charge of +2 C flows through the tube to the right, while a total charge of -1.5 C flows through it to the left. What is Δq passing to the right through a circular cross-section of the tube?

- a) +0.5 C
- b) +2 C
- c) +2.5 C
- d) +3.5 C
- e) +4 C

2. In the previous question, what is i ?

- a) 5 A to the left
- b) 0.35 A to the right
- c) 0.5 A to the left
- d) 2.5 A to the right
- e) 3.5 A to the right

3. *True or False:* According to Ohm's Law, the resistance R of a resistor depends on the voltage placed across it.

TRUE

FALSE

4. A 2-A current is moving through a wire with $100\ \Omega$ of resistance. How much electrical potential energy is lost by the charge carriers every second? (*Hint:* This is not asking about voltage, but you will need to find the voltage drop across the wire to find an answer.)

- a) 400 J
- b) 100 J
- c) 2 J
- d) 200 J
- e) 800 J

Useful expressions

$$i = \frac{\Delta q}{\Delta t}$$

$$v_{drift} = \frac{i}{neA}$$

$$R = \frac{\rho L}{A}$$

$$\Delta V = iR$$

Exercises

5. A 1-Amp current is flowing through two materials to the right (as shown below). One material is a section of metal wire. The other is a tube of conductive fluid containing equal numbers of equally charged positive and negative ions. Assume that in the fluid, positive and negative ions are equally able to move.

For each case (wire and fluid), indicate how much + and – charge moves through the material in a time interval of $\Delta t = 1 \mu s$ in the boxes provided and circle the correct arrow indicating the direction in which this charge moves.

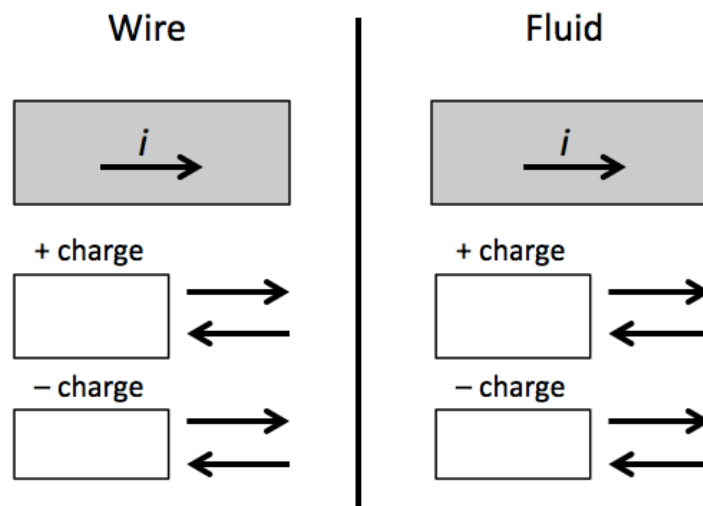

6. Electric eels bend around their prey to stun it, as shown in the figure below. In order to stun larger prey, they bend even more to reduce the gap between their two ends, as shown at right.

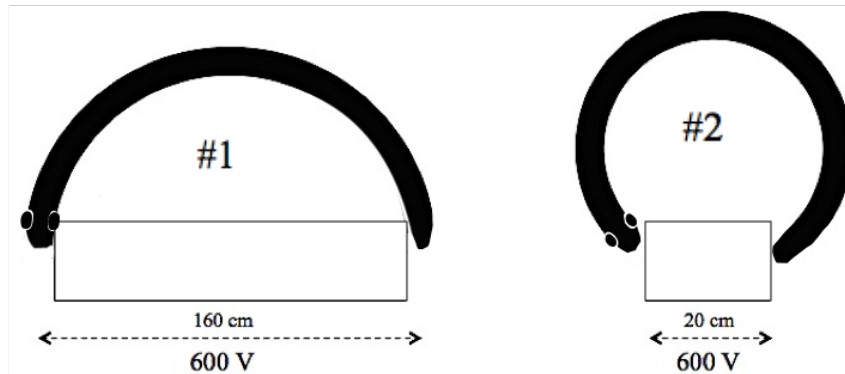

- A. Assuming a typical voltage difference of 600 V between the eel's head and tail, draw the equipotential lines for 100 V, 200 V, 300 V, 400 V, and 500 V in the boxes provided. (Assume the eel's tail is at 0 V and the eel's head is at 600 V. Also assume the E-field within the area of the box is uniform.)
- B. In which case does the electric field between the eel's head and tail have the greatest magnitude?
- C. In which case will the drift speed of electrons between the eel's head and tail be greater? (*Hint: Charges are moved by the E-field created by the voltage difference.*)
- D. In which case will the current through the eel's prey be greater?
- E. Sea water is a good conductor. Air is a poor conductor. Use this to explain why there are no electric snakes.

7. Two cylindrical conductors, A and B, are connected to a voltage source as shown. The length of conductor B is 3 times that of A, and the diameter of conductor A is 4 times that of B.

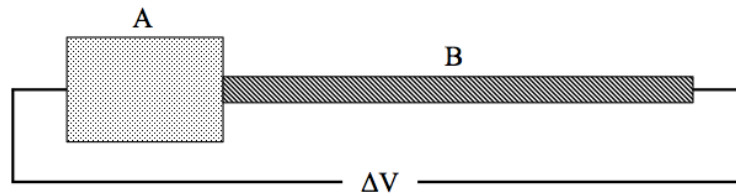

- A. Suppose both conductors are made out of the same material with identical numbers of moving charges per unit volume, n , and resistivity, ρ . Will there be a difference in the current passing through each conductor? If so, which current is greater?
- B. Will there be a difference in the drift speed of charges in each conductor? If so, which is greater?
- C. Will there be a difference in the voltage drop across each conductor? If so, which voltage drop is greater? (*Hint:* You'll need to determine which conductor has the largest resistance.)
- D. Now, imagine that the two conductors are made of different substances with different resistivities. Suppose that the resistivity of conductor A, ρ_A , is 60 times the resistivity of conductor B, ρ_B . Will the current still be the same in the two conductors?

8. A current is flowing through a cylindrical segment of conductive material with a shape as shown.

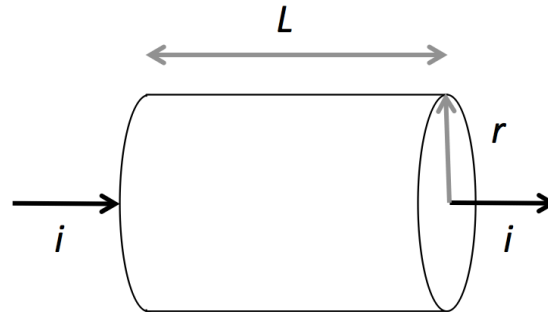

What could you be asked to find about this arrangement? Fill out as many of the lines as you can below. One has been finished for you as an example.

Given these quantities...	...what could you be asked to find?
The current through the material, the voltage drop across the segment, the length of the segment, and the resistivity of the material.	<ul style="list-style-type: none"> - The resistance of the segment - The cross-sectional area of the segment - The radius of the segment
The current through the material, the number density of free electrons in the material, and the radius of the segment.	
The resistance of the segment, the voltage drop across the segment, and an elapsed time.	
The voltage drop across the segment, the resistivity of the material, the length of the segment, and the radius of the segment.	
The drift velocity of electrons in the segment, the number density of free electrons in the material, and the radius of the segment.	

Circuits I

Group Questions

1. Decide whether the following statements are True or False:

A. When a single wire splits into two branches, the current always divides evenly between the branches.

TRUE FALSE

B. The sum of currents leaving a junction must be equal to the sum of currents entering the junction.

TRUE FALSE

C. The voltage difference between any two points in a circuit is always zero.

TRUE FALSE

2. For each circuit state which resistors, or network of resistors, are in series with each other and which resistors, or network of resistors, are in parallel with each other.

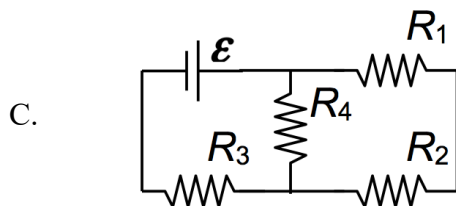
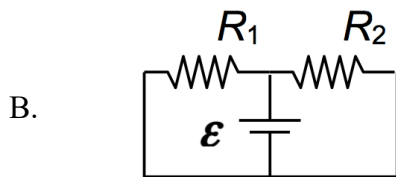
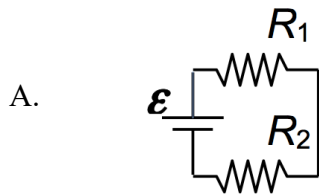

Useful expressions

$$R_{eq} = R_1 + R_2 \text{ (series)}$$

$$\frac{1}{R_{eq}} = \frac{1}{R_1} + \frac{1}{R_2} \text{ (parallel)}$$

$$\sum i_{in} = \sum i_{out} \text{ (Junction Rule)}$$

$$\Delta V_{loop} = 0 \text{ (Loop Rule)}$$

Exercises

3. Read and analyze the student statements regarding the two circuits shown at right.

- A. A battery is connected to a circuit containing two resistors in series. A student states:

“According to Ohm’s Law, the current is the voltage divided by the resistance, so when you have a bigger resistor, it will have a smaller current. In this case, resistor B has a larger resistance than resistor A, so it will have a smaller current.”

Do you agree or disagree with this statement? If you disagree, explain what is incomplete about this student’s reasoning.

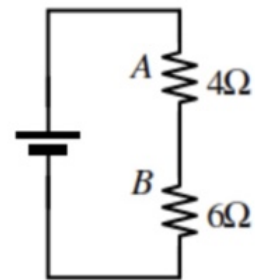

- B. A battery is connected to a circuit containing two resistors and a switch. A student states:

“When the switch is closed, the current through resistor A decreases, because it now has to share the current from the battery with resistor B.”

Do you agree or disagree with this statement? If you disagree, explain what is incomplete about this student’s reasoning.

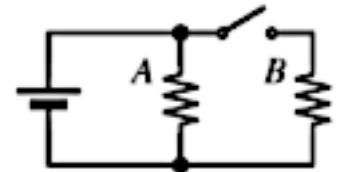

Circuits I

4. Consider the circuit to the right.

A. Rank the voltage at points A-E from greatest to least. Be sure to justify your answer.

B. Rank the magnitude of the current at the points shown. Again, justify your answer.

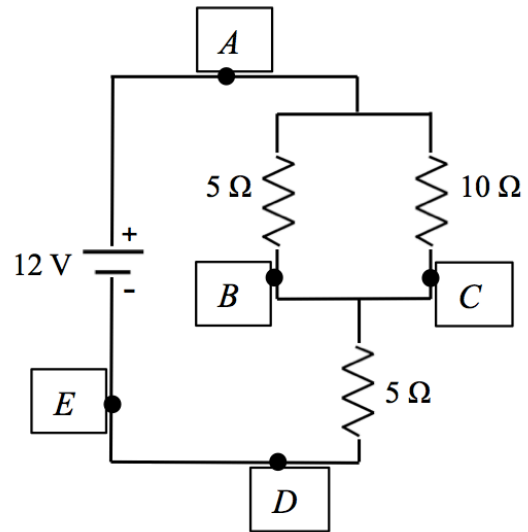

C. Is the current zero anywhere?

5. Consider the circuit shown at right. Currents, voltages, and resistances are as marked.

A. Using the Junction Rule, find the current through resistor R .

B. Using the Loop Rule, find the resistance of resistor R .

C. Find the unknown battery voltage \mathcal{E} .

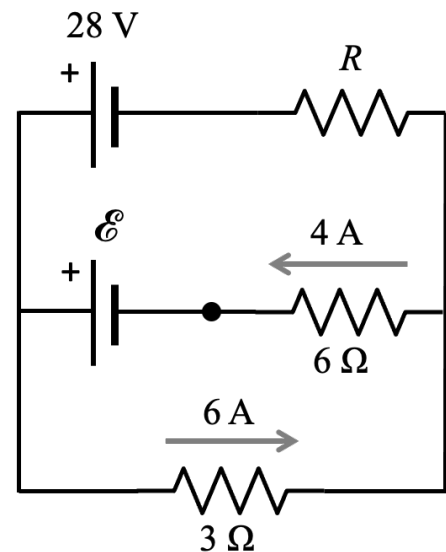

Circuits I

- D. If the circuit is broken at the point marked with a dot in the middle branch, what will be the new current through resistor R ?

6. Consider the circuit to the right, where $R_1 = R_2 = 10\ \Omega$, $\mathcal{E}_1 = 5\ \text{V}$, and $\mathcal{E}_2 = 10\ \text{V}$.

- A. In this circuit you are given none of the currents. Start by identifying all the loops in this circuit. Which single loop will allow you to solve for the current through R_1 ?

- B. Solve for the current through R_1 using the Loop Rule. (Remember to specify the direction.)

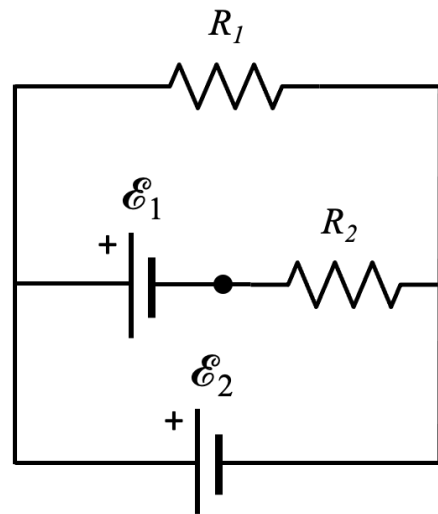

- C. What is the current through R_2 ?

- D. Finally, solve for the current supplied by battery \mathcal{E}_2 .

- E. If this circuit is broken at the point marked with a dot in the middle branch, will the current through R_1 *increase*, *decrease*, or *stay the same*?

- F. Will the current supplied by battery \mathcal{E}_2 *increase*, *decrease*, or *stay the same*?

Circuits I

7. Now try solving for the two missing currents in the circuit at right. Use $R_1 = 4 \Omega$, $R_2 = 2 \Omega$, $R_3 = 12 \Omega$, $\mathcal{E}_1 = 16 \text{ V}$, $\mathcal{E}_2 = 12 \text{ V}$.

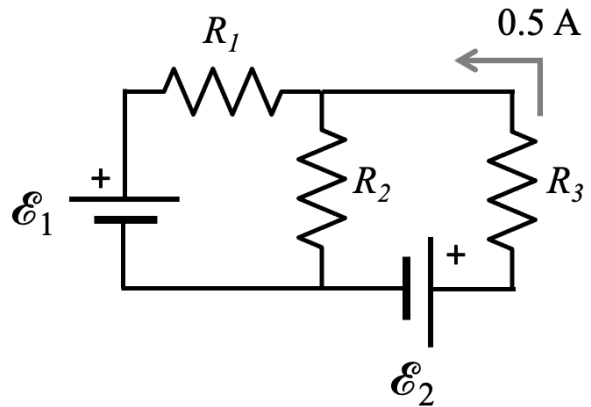

8. Sometimes a good choice of loop can make even the most scary-looking circuits much easier to solve. Take a close look at the circuit below. All of the resistors are identical, with a resistance of 1Ω . The current between points A and B is 3 A in the direction shown. What is the magnitude and direction of the current between points B and C? (*Hint: Try finding a loop that contains only batteries and a single resistor.*)

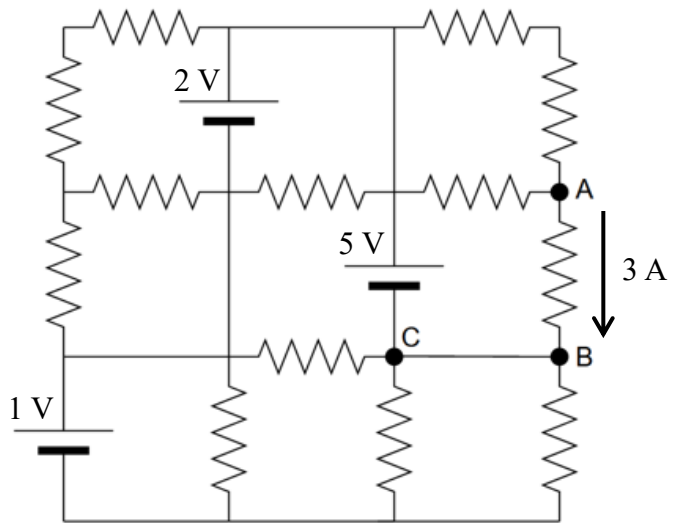

How many other currents can you find by applying Kirchhoff's Rules to this circuit?

Circuits II

Group Questions

1. Match each situation with the equation that would be most appropriate to calculate power.

$$P = iV$$

$$P = \frac{V^2}{R}$$

$$P = i^2R$$

- A 1200- Ω resistor is connected to a 15-V battery. What is the power dissipated by the 1200- Ω resistor?
- A 200- Ω resistor is in series with two other resistors of unknown resistances and a 15-V battery. The equivalent resistance of all three is 600 Ω . What is the power dissipated by the 200- Ω resistor?
- A 750- Ω resistor is connected in parallel with two other resistors to a 12-V battery. What is the power dissipated by the 750- Ω resistor?
- A resistor has a current of 4 A running through it and a voltage of 6 V across it. What is the power dissipated by this resistor?
- A 1000- Ω resistor is in a simple circuit (no junctions) with a battery. The current through the circuit is 0.5 A. What is the power dissipated by the 1000- Ω resistor?

2. What is the potential difference across the plates of an uncharged capacitor immediately after connecting it to a battery with voltage \mathcal{E} ?

- a) \mathcal{E}
- b) $\mathcal{E}/2$
- c) $\mathcal{E}/3$
- d) $\mathcal{E}/4$
- e) zero

Bonus Question!

What does “immediately after” mean?

- a) $t = 0$
- b) $t = RC$
- c) $t = \infty$

3. A fully charged capacitor with capacitance C is inserted into a circuit with a single resistor of resistance R and no battery. Sketch the graphs of the charge on the capacitor over time and the current in the circuit over time:

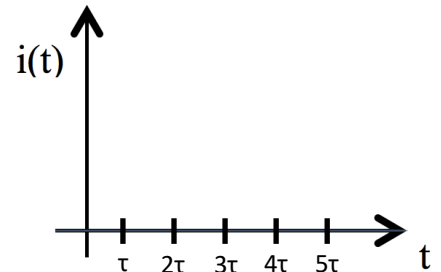
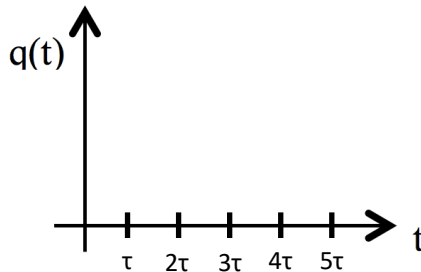

4. What could you do to make the current in the circuit described in question 3 decrease faster?

- a) Increase C
- b) Decrease R
- c) Nothing – the time constant is a constant

Useful expressions

$$P = iV = i^2R = \frac{V^2}{R}$$

Charging a capacitor

$$q_{cap}(t) = C\varepsilon(1 - e^{-t/RC})$$

$$\Delta V_{cap}(t) = \varepsilon(1 - e^{-t/RC})$$

$$i_{cap}(t) = \frac{\varepsilon}{R} e^{-t/RC}$$

Discharging a capacitor

$$q_{cap}(t) = q_{max}e^{-t/RC}$$

$$\Delta V_{cap}(t) = \frac{q_{max}}{C} e^{-t/RC}$$

$$i_{cap}(t) = -\frac{q_{max}}{RC} e^{-t/RC}$$

Exercises

5. A 200- Ω resistor is in series with two other resistors of unknown resistances and a 15-V battery. The equivalent resistance of all three is 600 Ω .

A. What is the power dissipated by the 200- Ω resistor?

B. Did you use the equation you chose in question 1 above, or a different one?

6. A cell membrane at its resting potential can be modeled as an RC circuit with capacitor, resistor, and battery in series.

The resistance of the ion gates depends on the size of the cell. For a cell 50 μm in radius, $R = 25,000,000 \Omega$. Similarly, the capacitance of a cell membrane depends on the size of the cell. For a cell with a radius of 50 μm , $C = 78.5 \text{ pF}$.

A. What is the time constant of the cell membrane as we've modeled it here?

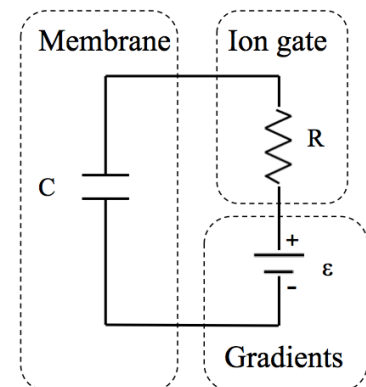

- B. Over what approximate timescale would you expect changes in the voltage across the cell membrane to occur? (Circle one)

nanoseconds microseconds milliseconds seconds

- C. Which of the following most accurately represents what the time constant is?

- A measure of how much charge will accumulate in a system.
- A measure of how much time it takes to return a system to its initial state.
- A measure of how long it takes a system to change.
- A measure of how large the voltage change in a system will be.
- A measure of the overall complexity of a system.

- D. The propagation speed of the action potential down an axon is inversely proportional to the time constant of the neuron's cell membrane. Use this fact to explain why action potentials propagate more rapidly when the axons are coated in a thick myelin sheath. (*Hint: Think about the membrane as a capacitor and recall how capacitance varies with geometry.*)

7. In the circuit shown, C is an uncharged capacitor with capacitance of 12 mF, R is a resistor with resistance 50 Ω , and ε is a battery with voltage 5 V. The switch is closed and the capacitor begins charging.

- A. Indicate the direction of the current (while there is one) on the diagram.
- B. Indicate which plate of the capacitor is accumulating positive charge and which side is accumulating negative charge.

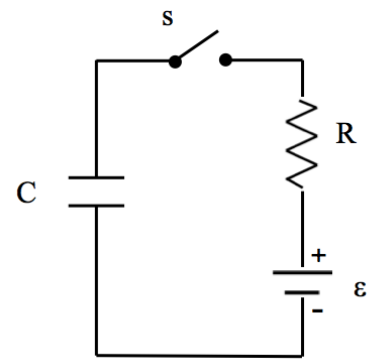

- C. At $t = 2\tau$, what is the charge on the capacitor, the current through the resistor, and the potential difference across the capacitor?

$$q(2\tau) = \boxed{} \quad i(2\tau) = \boxed{}$$

- D. What is the potential difference across the capacitor when $t = 2\tau$? (*Hint*: Remember the definition of capacitance.)

- E. What is the charge on the capacitor, the current through the resistor, and the voltage difference across the capacitor after a long time has passed?

$$q(\infty) = \boxed{} \quad i(\infty) = \boxed{} \quad \Delta V(\infty) = \boxed{}$$

8. We now take the fully charged capacitor and place it in another circuit, this time without a battery. In this case, $R = 25 \Omega$.

- A. Assuming we haven't changed the orientation of the capacitor at all, indicate which side of the capacitor has accumulated positive charge and which side has accumulated negative charge.

- B. Draw the direction of the current in this circuit as the capacitor is discharging. Is this direction the same or different than the one you drew in 7A?

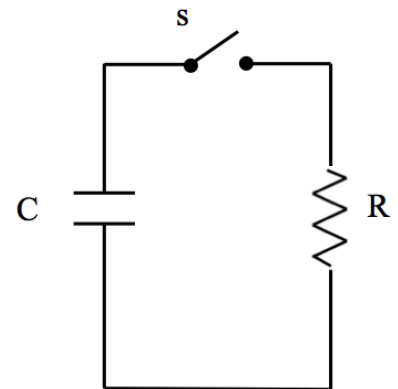

- C. What is the current through the resistor at $t = 0$, the instant when the switch is closed?

Circuits II

- D. What is the charge on the capacitor, the current through the resistor, and the energy stored in the capacitor at $t = 1.2$ s?

$$q(1.2 \text{ s}) = \boxed{} \quad i(1.2 \text{ s}) = \boxed{} \quad U_{cap}(1.2 \text{ s}) = \boxed{}$$

- E. At what time t will the capacitor reach 50% of its maximum charge? [*Hint*: $\ln(e^x) = x$. Be sure to use the function “ \ln ” on your calculator. This is called the natural log.]

Magnetism and Magnetic Forces

Group Questions

1. Use the right-hand rule to draw the direction of the magnetic force on each of the charged particles moving in the uniform B-field shown. (Remember to pay attention to the sign of the charge.)

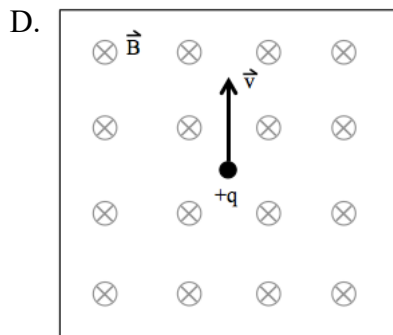
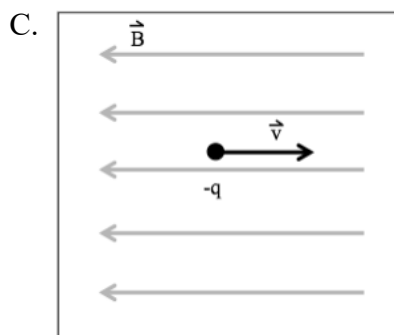
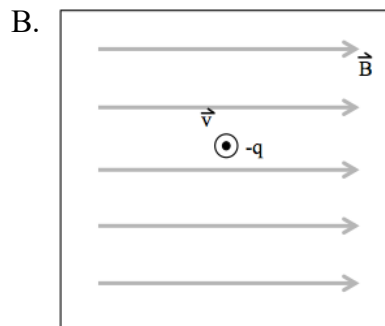
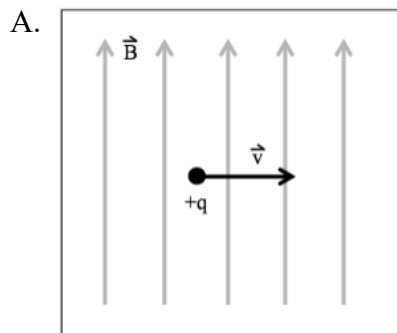

2. Use the right-hand rule to draw the direction of the magnetic force on each of the current-carrying wires in the uniform B-field shown.

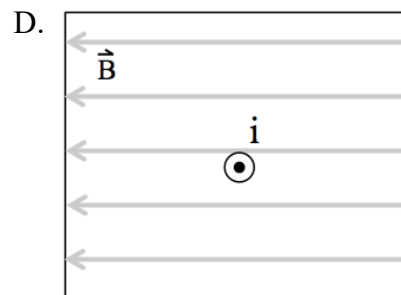
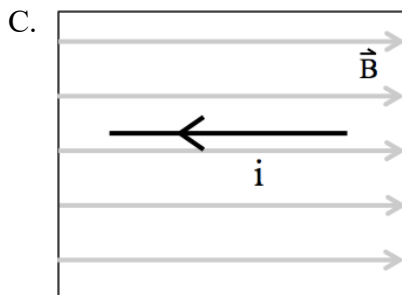
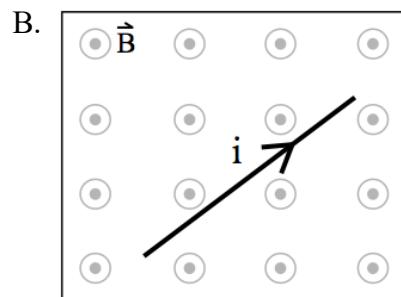
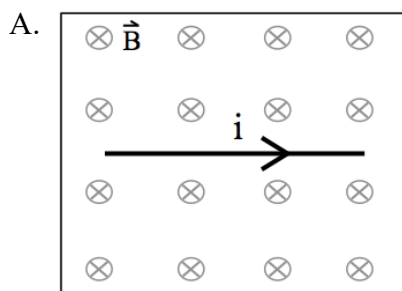

Useful expressions

$$F_B = |q|vB \sin \theta$$

$$F_B = ilB \sin \theta$$

$$r = \frac{mv}{qB}$$

Exercises

3. Two isotopes of Iodine, I^{127} and I^{123} , are fired into a mass spectrometer, as shown. Assume both isotopes have been stripped of a single electron.
- A. Which path would I^{127} follow, and which would I^{123} follow? Indicate your choice on the diagram.

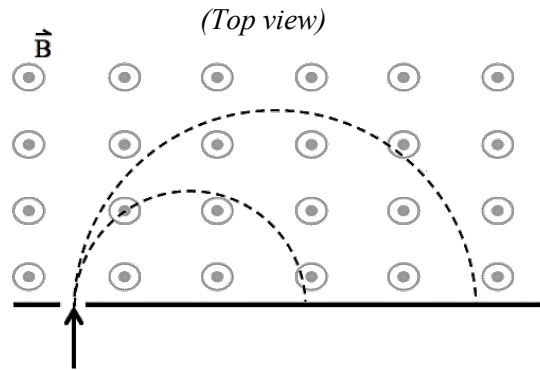

- B. Take the mass of I^{123} to be 2.04×10^{-25} kg and the mass of I^{127} to be 2.11×10^{-25} kg. Both have a net charge of $+1.6 \times 10^{-19}$ C. If they are fired into the spectrometer with a velocity of 3000 m/s and the magnitude of the B-field they encounter is 0.2 T, how far apart will they land?
- C. If you want to increase the distance between where the two isotopes land to make it easier to separate them, which can you change about the situation?

4. The Northern Lights (Aurora Borealis) are the product of an interaction between charged particles from the sun (the solar wind) and the Earth's magnetic field.

To understand this interaction, consider a particle with charge $+q$ that enters a B-field with a velocity as shown at right. Both the B-field lines and the velocity of the particle are in the plane of this page. We want to describe the subsequent path of the particle.

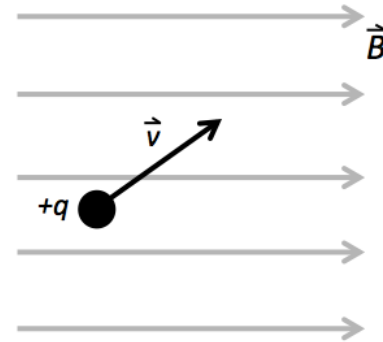

- A. Make a prediction about how you think the particle will move in the field.

- B. At the instant shown, in what direction is the magnetic force on the particle?

- C. Does your conclusion in B change the prediction you made in A? If so, how?

- D. The challenge of this situation is that the force from C will change the velocity of the particle, which (because the force depends on the orientation of the velocity with respect to the B-field) will change the force. One commonly used trick to get around this problem is to break the velocity up into two components – one that you know will not change over time, and one that you know will change in a predictable way.

So, with this in mind, break the velocity vector of the particle into two components, one of which will not be changed by the B-field. Remember, the two components must be separated by an angle of 90 degrees. Draw both components on the diagram of the particle above.

- E. What will happen to the component you drew in D that will change? If you need help, draw the component on the picture to the right, which shows the B-field as if you were looking at it from the right side of the page.

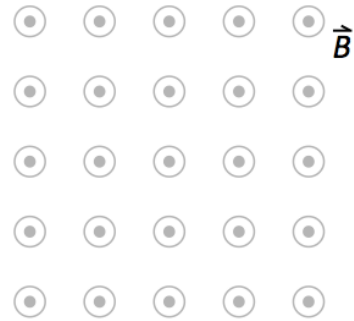

- F. Re-evaluate the predictions you made in A and C. What kind of path do you think the particle will move in now?

- G. Here is a drawing that represents what happens when charged particles from the sun enter the Earth's magnetic field. Does what you see match your answer to F? Use this drawing and your conclusion in F to explain why the Northern Lights only occur far north of the equator.

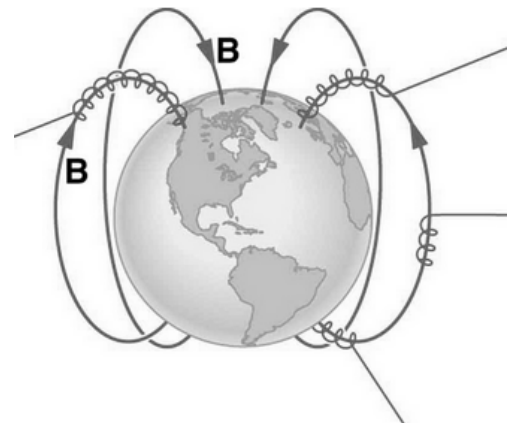

5. When animals, such as some kinds of birds and fish, use the Earth's magnetic field to navigate, they do not do so like a person might use a compass to determine north or south. Birds might go south in winter in the northern hemisphere, but they go north in winter in the southern hemisphere. Though precise mechanisms are still a topic of active research, it's currently believed that animals with magnetoperception sense the inclination of the Earth's B-field (that is, its angle with respect to the horizontal), which changes the closer or further you get to the equator. Look at the picture of the Earth's B-field shown and determine which image below (1 or 2) is closer to the equator.

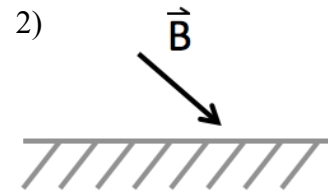
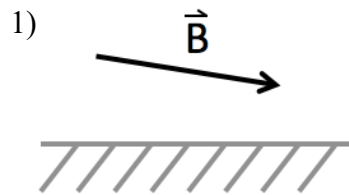
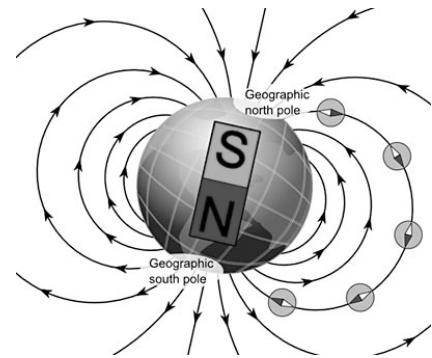

6. An airliner is flying through the Earth's magnetic field. For simplicity's sake, let's only consider the component of the Earth's field that is perpendicular to the velocity of the airliner.

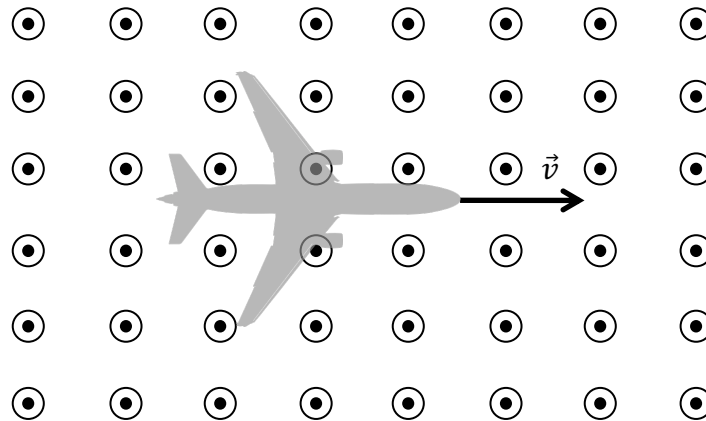

In this situation, there will be a voltage between the wingtips of the airliner. The larger its velocity, the greater this voltage will become. Why does this voltage exist, and why does it depend on the velocity of the airliner? (*Hint*: Recall that aircraft are made from metal, which is a conductor.)

Magnetism and Current

Group Questions

1. What will be the resulting motion of the current-carrying wire loop shown in the figure at right?

- The loop will remain stationary.
- The top of the loop will rotate up out of the page and the bottom of the loop will rotate into the page.
- The right side of the loop will rotate up out of the page and the left side of the loop will rotate into the page.
- The top of the loop will rotate into the page and the bottom of the loop will rotate up out of the page.
- The right side of the loop will rotate into the page and the left side of the loop will rotate up out of the page.

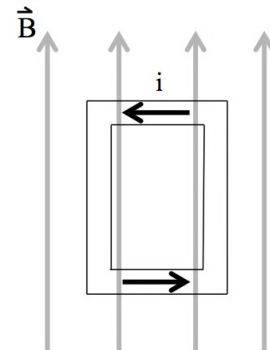

2. Rank the magnitudes of the magnetic fields at points P, Q, R, and S. All points are equidistant with respect to the wires.

- $B_Q = B_R > B_P = B_S$
- $B_P > B_Q > B_R > B_S$
- $B_Q > B_R > B_S > B_P$
- $B_S > B_Q = B_R > B_P$
- $B_R > B_S > B_P > B_Q$

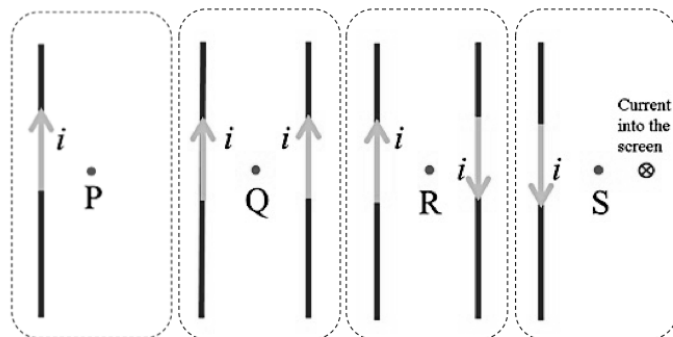

3. Two circular loops of the same dimensions carry current i as shown. Which configuration of magnets best matches this situation?

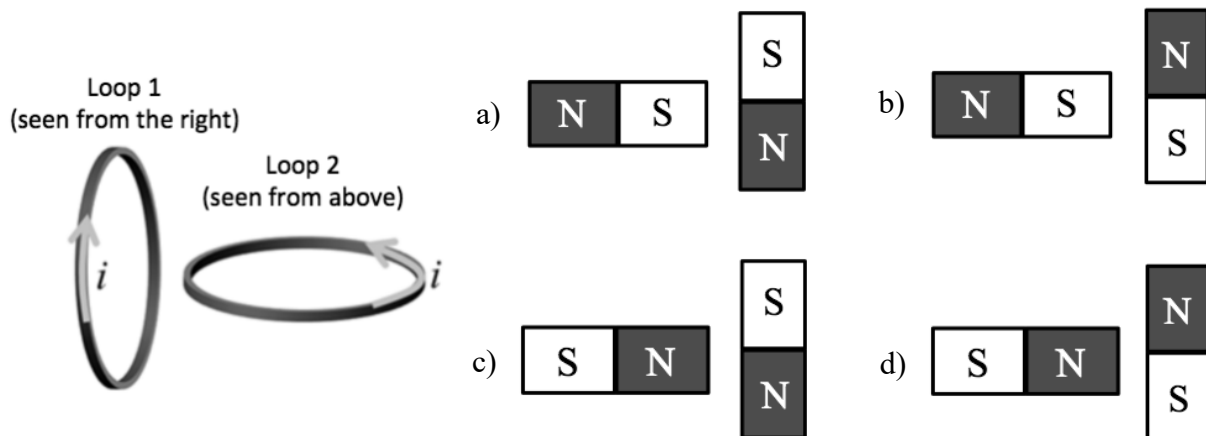

Useful expressions

$$\tau_{loop} = iAB \sin \theta$$

$$B_{wire} = \frac{\mu_0 i}{2\pi r}$$

$$B_{solenoid} = \mu_0 ni$$

$$\mu_0 = 4\pi \times 10^{-7} \text{ T} \cdot \text{m/A}$$

Exercises

4. A current-carrying wire loop (which is just a single-loop solenoid) can mimic the magnetic field created by a permanent magnet (shown on the right).

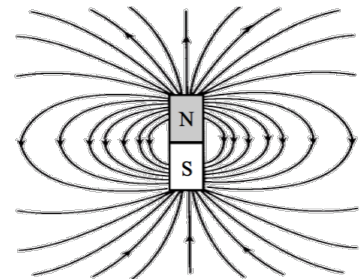

- A. Which orientation of the loop would match the field pictured? (*Hint: think about the direction of the B-field created at the center of the loop and remember the field lines always point away from the north pole and toward the south pole.*)

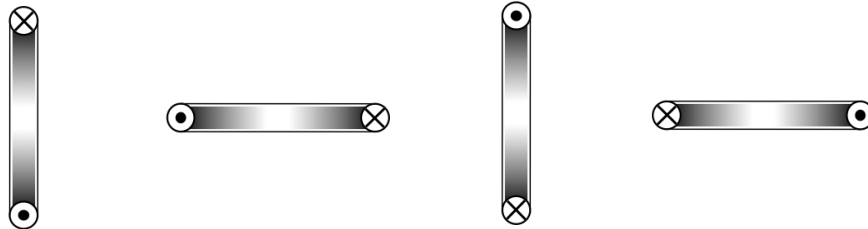

- B. Use your conclusion in A to determine whether the following pairs of loops will repel, attract, or have no effect on one another.

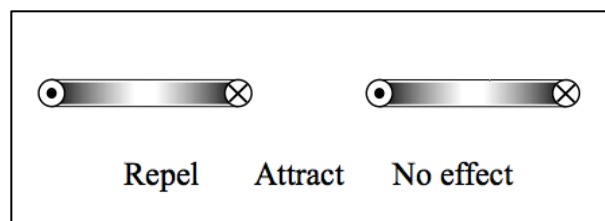
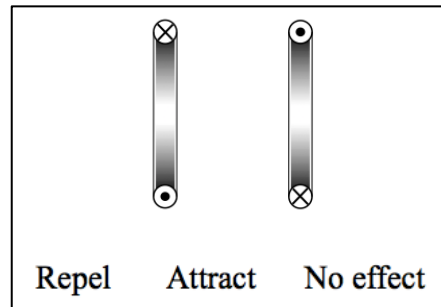
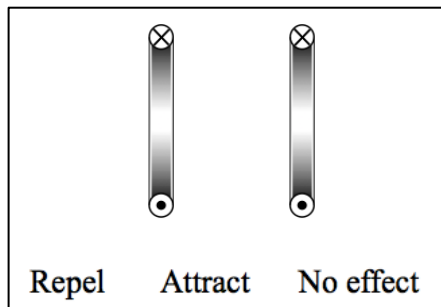

Magnetism and Current

5. Use the right-hand rule to determine the direction of the magnetic field near the current-carrying wires below.

- A. Draw the direction of the B-field created by the current at the points *A* and *B*. If necessary, use the \otimes and \odot symbols to indicate into and out of the page, respectively.

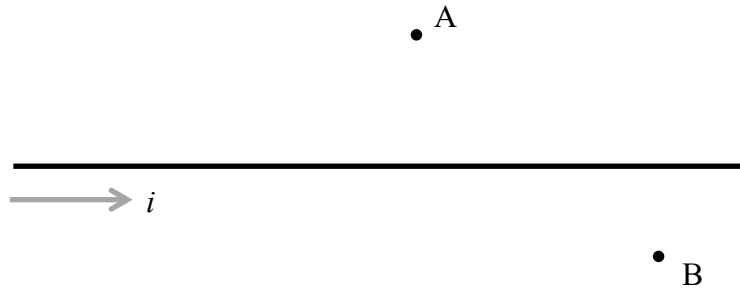

- B. On the diagram at right, draw the magnetic field vector at points 1, 2, and 3. Be sure to specify the direction and relative magnitude.

- C. If $B_1 = 1$ T, what are B_2 and B_3 ?

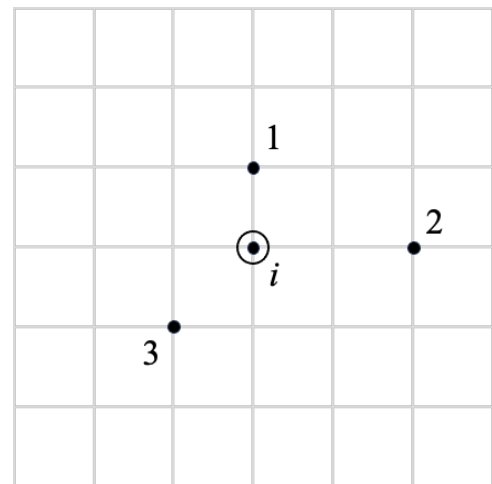

- D. On the diagram at right, draw the direction of the net magnetic field at points *C* and *D*.

- E. If each current is 20 A and the gridlines are 1 mm apart, what are the magnitudes of B_C and B_D ?

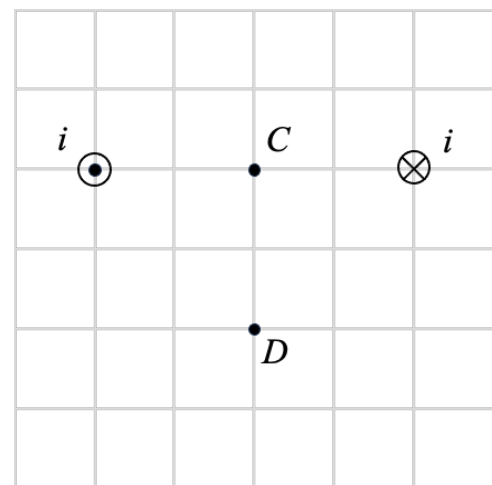

6. Each of the wire loops shown has equal area and carries the same current in the direction indicated.

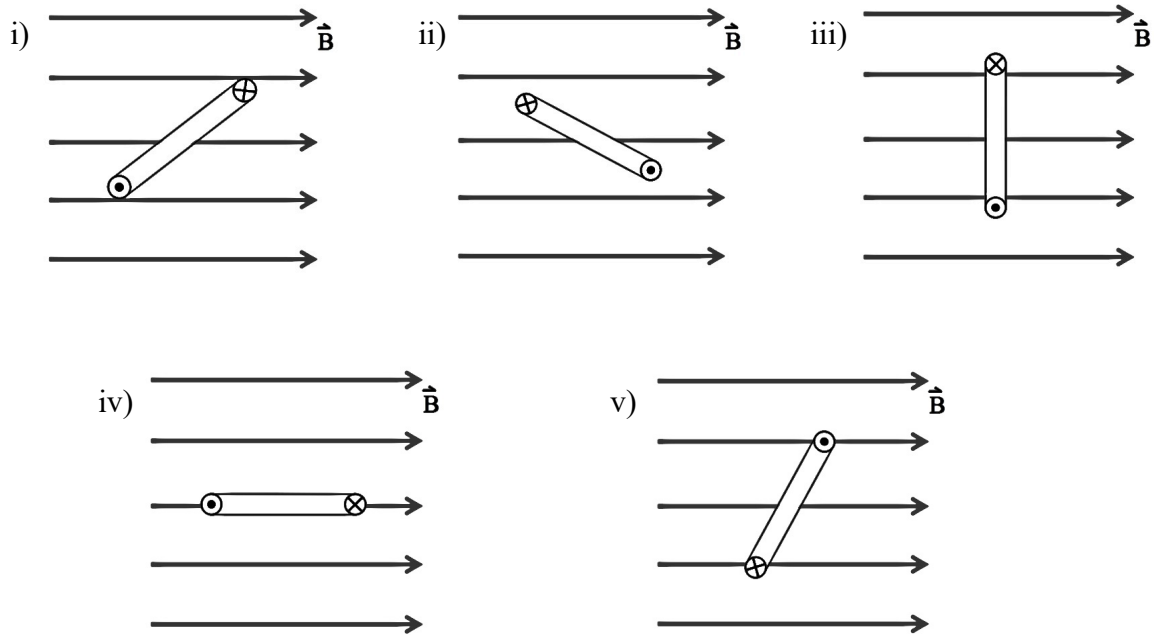

A. In each case, indicate the direction of the B-field created by the loop at the center of the loop. This is not the external B-field. (To find the B-field at the center, you can apply the right-hand rule along the wire's circumference and see where the net field is pointing.)

B. Assuming that the external B-field has the same magnitude in each case, circle the case where the magnitude of torque on the loop is the greatest.

C. Circle the case where the magnitude of torque on the loop is the least.

D. In which direction will each loop rotate?

i) Clockwise or Counterclockwise

ii) Clockwise or Counterclockwise

iii) Clockwise or Counterclockwise

iv) Clockwise or Counterclockwise

v) Clockwise or Counterclockwise

7. A particular DC motor spins at 60 revolutions per minute when a given voltage is applied. What possible changes could you make to get the motor to spin faster?

Electromagnetic Induction

Group Questions

1. A loop is in the magnetic field of a bar magnet. Which of these would not change the magnetic flux through the loop?

- a) Tilting the loop around a vertical or horizontal axis
- b) Moving the loop toward or away from the magnet
- c) Changing the loop area by increasing or decreasing its radius
- d) Spinning the loop clockwise or counterclockwise
- e) Moving the loop from side to side
- f) Moving the magnet toward or away from the loop

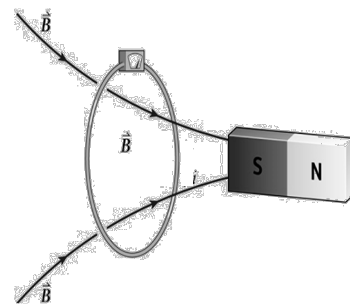

2. If you move the magnet shown to the right, what can you say about the magnetic flux through the wire loop?

- a) The flux will increase.
- b) The flux will decrease.
- c) The flux will not change.

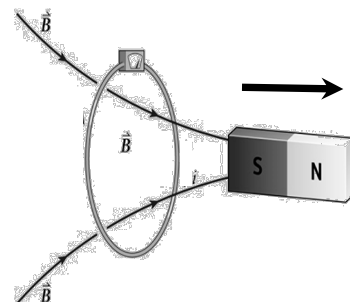

3. Flux is not really a vector, but we can imagine it as an arrow whose length indicates the amount of magnetic flux passing through an area. Below is just such an arrow representing the initial flux through the wire loop before you start moving the magnet. Draw in the final flux through the loop after the magnet moves and the change in flux between the initial and final positions of the magnet in the next two boxes.

Initial flux (Φ_0)



Flux after magnet moves (Φ_f)

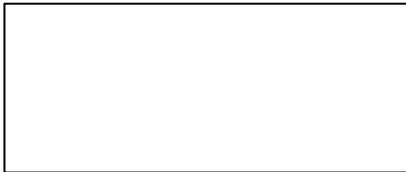

Change in flux ($\Delta\Phi$)



4. In which direction will the induced magnetic field be at the center of the loop in order to oppose the change in the flux?

- a) Right
- b) Left
- c) There will be no induced magnetic field

Useful expressions

$$\Phi_B = AB \cos \theta \quad (\text{where } \theta \text{ is the angle between the field and a normal to } A)$$

$$\varepsilon = -N \frac{\Delta \Phi_B}{\Delta t}$$

Exercises

5. Experiments to study vision often need to track eye movements. One way of doing so is to have the person sit in a magnetic field while wearing contact lenses with a coil of very fine wire circling the edge. A current is induced in the coil each time the person rotates their eye. Imagine a 20-turn, 6.0-mm-diameter coil of wire circles the person's cornea while a 1.4 T magnetic field is directed as shown in the figure.

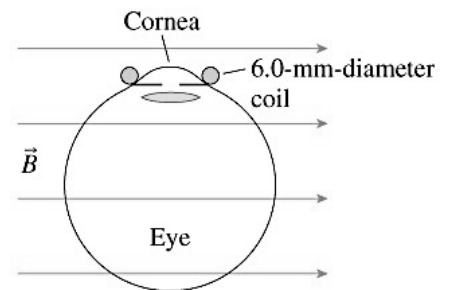

- A. What are the initial and final magnetic fluxes through the coil if the person shifts their gaze by 6° in 0.35 s?
- B. What emf is induced in the coil? (Note that in cases where there is more than one loop in a coil, the emf is multiplied by the number of loops.)

6. A magnet is held above a conducting loop with its N pole pointed down as shown. We will raise the magnet and ask what effect that has on the loop in terms of currents and forces.

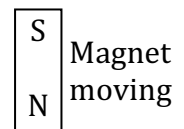

- A. Draw the B field lines inside the loop due to the magnet. Explain.



Electromagnetic Induction

- B. As you raise the magnet, does the external magnetic flux, Φ_{ext} , *increase, decrease, or remain the same*? Explain.
- C. As you raise the magnet is there an emf, \mathcal{E} , induced around the loop? Explain.
- D. As you raise the magnet is there an induced B field, \vec{B}_{ind} , inside the loop? If so, which way does it point? Explain.
- E. As you raise the magnet is there an induced current, i_{ind} , around the loop? If so, indicate its direction on the figure above. Explain.

- F. Look at your answer to D and draw a magnet in the dashed oval that will behave just like the loop. Explain.

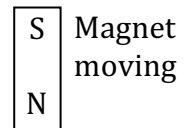

- G. Finally, as the magnet is moving up, what is the direction of the magnetic force on the loop? Explain.

Electromagnetic Induction

7. A conducting loop is in a static magnetic field as shown at right. The magnetic field is zero outside the box.

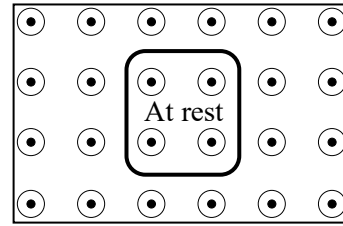

- A. Will current flow around the loop in this situation? If so, in which direction? Explain.

- B. Now the loop moves from left to right through the field as shown. For the three situations shown, state whether or not there will be current flowing around the loop. Explain.

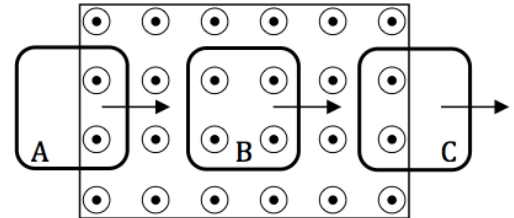

- C. Indicate the direction of the loop's current for the case(s) where an induced current is produced. Explain. (*Hint: You will need a RHR.*)

- D. Plot the flux, Φ , the induced current, i , and the EMF, \mathcal{E} , as a function of time. Take out of the page (or counterclockwise) as positive. At $t = 0$ s the loop's right edge is just entering the field, at $t = 1$ s the loop is at location A, at $t = 4$ s the loop is at location B, at $t = 7$ s the loop is at location C, and at $t = 8$ s the loop's left edge has just exited the field.

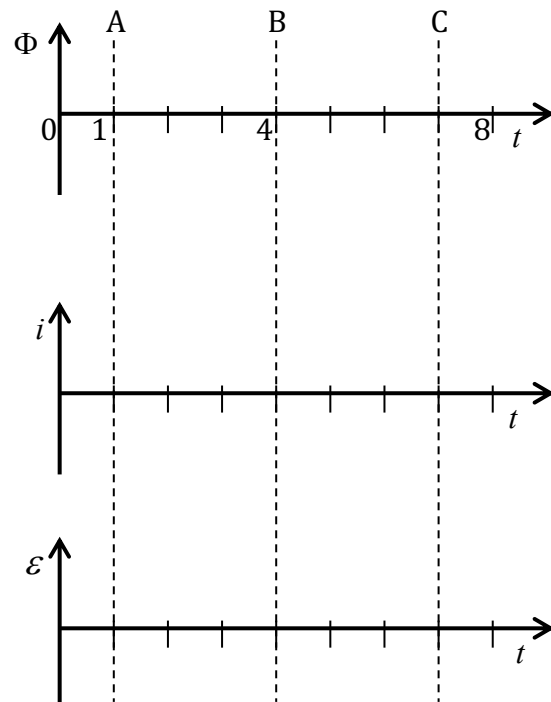

Electromagnetic Induction

8. Consider the conducting loop and solenoid shown. When the switch is closed the solenoid current increases quickly from 0 A to 1 A and then remains steady at 1 A.

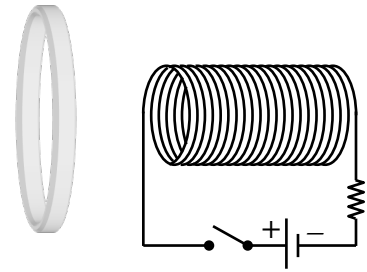

- A. On the diagram, indicate the direction of the current around the solenoid with the switch closed.
- B. On the diagram indicate the direction of the B field created by the solenoid, at the center of the loop. Which RHR did you use?
- C. Will there be an induced current in the loop? Select an answer and justify your choice.
- a) No.
 - b) Yes, but only while the switch remains closed.
 - c) Yes, but only after the current has reached the 1 A maximum.
 - d) Yes, but only while the current in the solenoid is increasing.
9. An application of magnetic induction is magnetic braking, a method used to slow moving (conducting) objects with magnets. To show this let's consider a magnet dropped into a metal tube.

To help understand what happens to this magnet, think about three “loops” (that is, pieces of the metal tube). Use what you know about the currents that will be induced in these three “loops” to explain why the magnet will experience a braking force upward.

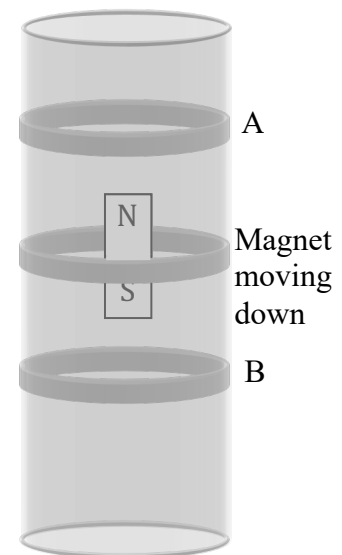

Electromagnetic Waves

Group Questions

1. The human body gives off the most electromagnetic radiation at a frequency of 25 THz ($T = 10^{12}$). What is the wavelength of this radiation?

- a) 7 cm
- b) 5.2 mm
- c) 36 m
- d) 160 nm
- e) 12 μm

2. Use the chart at the right to identify the type of electromagnetic wave from question 1.

- a) Microwave
- b) Gamma wave
- c) Infrared wave
- d) Ultraviolet wave
- e) Visible light

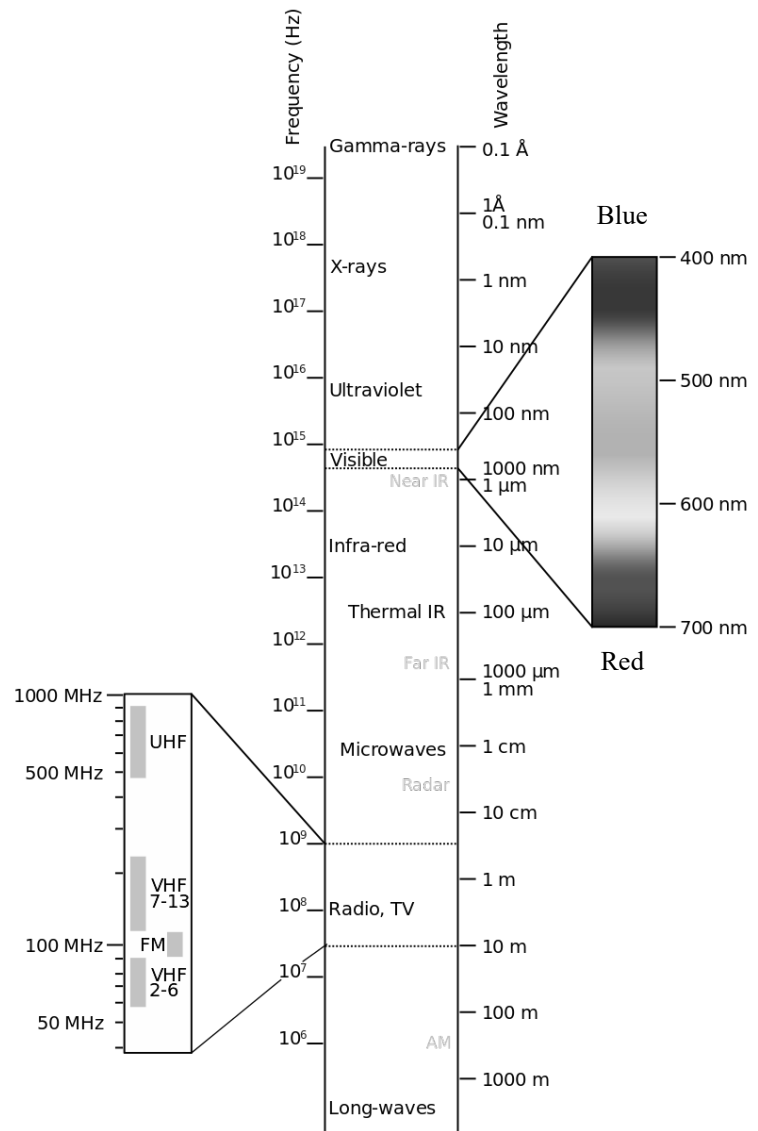

3. If you triple your distance from a radio transmitter, by what factor does the intensity of the radio waves you receive change?

- a) Decreases by a factor of 3
- b) Decreases by a factor of 9
- c) Increases by a factor of 3
- d) Increases by a factor of 9
- e) Doesn't change

Useful expressions

$$c = f\lambda$$

$$c = 3 \times 10^8 \text{ m/s in a vacuum}$$

$$E_0 = cB_0$$

$$I = \frac{1}{2} c \epsilon_0 E_0^2 = \frac{c B_0^2}{2\mu_0} = \frac{E_0 B_0}{2\mu_0}$$

Exercises

4. Three electromagnetic waves are shown below:

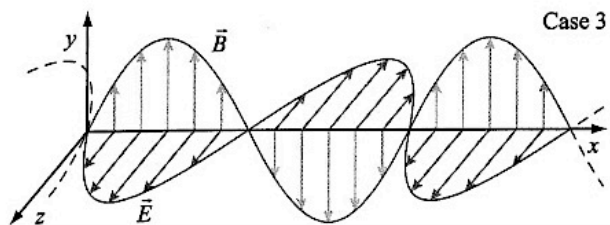
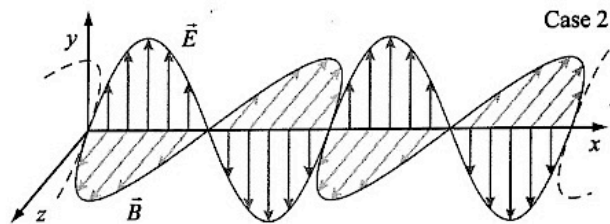
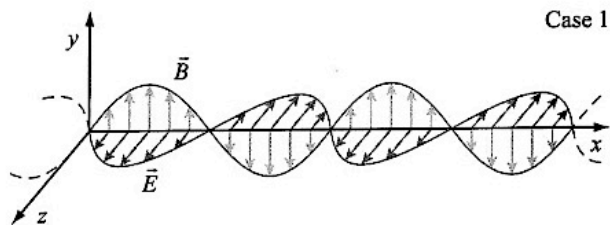

A. Rank the following quantities for the three waves:

Speed (v_1, v_2, v_3) _____

Wavelength ($\lambda_1, \lambda_2, \lambda_3$) _____

Frequency (f_1, f_2, f_3) _____

Intensity (I_1, I_2, I_3) _____

- B. If the wave in case 2 were green light, could the wave in case 3 be red light or blue light? Explain your choice.
- C. Suppose you're using a thin conducting wire as an antenna to receive each of these magnetic waves. Describe the orientation of the wire in each case that would provide the best reception. (*Hint*: Think about how charges will move in the wire in response to the waves.)
5. As a general rule, an object must be at least as large as the wavelength of light incident upon it in order to be detectable by that light.
- A. What is the smallest object that can be detected using visible light?
- B. If you wanted to image smaller objects, what sorts of electromagnetic radiation would you use?
- C. Most radar can detect objects that are at least 30 cm in size. What is the frequency of EM radiation used by such radar?
- D. A similar rule applies to structures that you use to detect electromagnetic waves – they should be similar in size to the wavelengths of the waves they are meant to detect. Use this fact to explain why no biological organisms rely primarily on radio waves to sense their environment.

6. The power output of the Sun in the form of electromagnetic waves is 3.85×10^{26} W. The Earth is 1.5×10^{11} m from the Sun.
- A. What is the intensity of the Sun's light at the location of the Earth? (*Hint*: Remember that intensity is power per unit area. What is the area over which the Sun's light is spread at the location of the Earth?)
- B. What is the total power delivered to the Earth by the Sun? (*Hint*: The light that the Earth collects is the same as the light that falls on a disk with the radius of the Earth, 6.4×10^6 m.)
- C. If 30% of the Sun's light that is incident on the Earth is reflected back into space, how much available power reaches the surface of the Earth in the form of sunlight?
- D. The average global energy usage per capita is about 3.3×10^{11} Joules per year. If a solar panel is able to convert 20% of the sunlight it collects into usable power, how large would a solar panel need to be in order to supply the average citizen of Earth with the power they consume?

Electromagnetic Waves

7. Below is a chart showing how much EM radiation liquid water absorbs as a function of wavelength. The higher the line, the more water absorbs that particular wavelength. The lower the line, the more that wavelength will be transmitted through.

Use this chart to explain why water often appears to be blue.

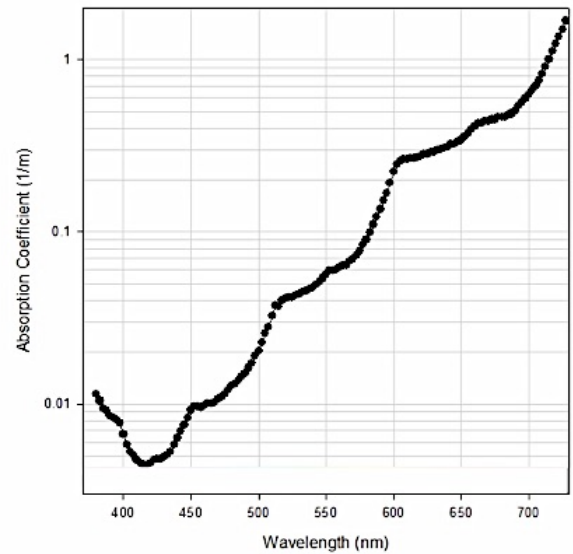

Reflection, Refraction, and Dispersion

Group Questions

1. When a ray of light travels from one medium to another with a different index of refraction, which properties of the light change? (Select all that apply.)
 - a) Speed
 - b) Frequency
 - c) Wavelength
 - d) None of the above

2. When a ray of light moves from a medium with a low index of refraction to a high index of refraction, how will it refract?
 - a) It will bend toward the normal to the surface.
 - b) It will bend away from the normal to the surface.
 - c) It won't refract – it will always be totally internally reflected.

3. Which of the following statements about total internal reflection are true? (Select all that apply.)
 - a) Total internal reflection is only possible when the incident ray goes from a medium with higher n towards a medium with a lower n .
 - b) Total internal reflection is only possible when the incident ray goes from a medium with a lower n towards a medium with a higher n .
 - c) Total internal reflection occurs when the angle of incidence is smaller than the critical angle.
 - d) The critical angle for total internal reflection depends only on the n of the medium that the incident ray originates from.
 - e) The critical angle for total internal reflection depends on the n of the media on both sides of the interface.

Useful expressions

$$\theta_1 = \theta_1'$$

$$n = \frac{c}{v}$$

$$n_1 \sin \theta_1 = n_2 \sin \theta_2$$

$$\theta_c = \sin^{-1}\left(\frac{n_2}{n_1}\right)$$

Exercises

4. Two plane mirrors are positioned at right angles to one another. A light ray is incident on Mirror 1 at an angle of 40° with respect to the normal to the surface, as shown.

- A. Draw the reflected light ray from Mirror 1. What is the angle of reflection?

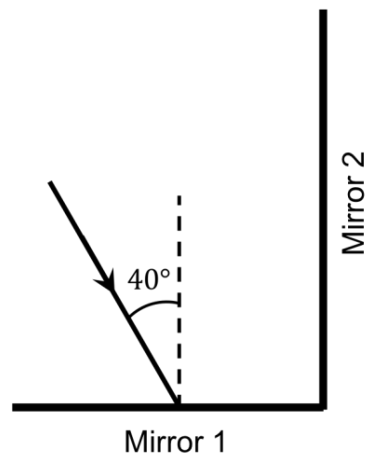

- B. What is the incident angle of this ray with Mirror 2?

- C. Draw the ray that is reflected from Mirror 2. What is the angle of reflection?

- D. How does the direction of this ray compare to the direction of the original ray incident on Mirror 1?

Reflection, Refraction, and Dispersion

5. Consider a ray of light incident on a surface as shown.

A. Fill in the boxes with the correct terms.

B. If n_1 and n_2 are the indices of refraction in medium 1 and 2 respectively, write an expression for the ratio of $\sin \theta_1 / \sin \theta_2$ in terms of n_1 and n_2 .

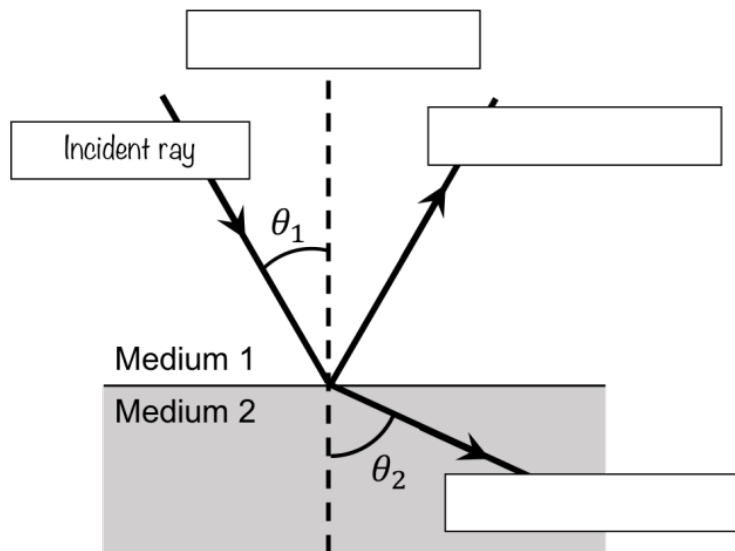

C. Based on the image above, is n_2 smaller or larger than n_1 ?

D. Is the speed of light in medium 2 higher or lower than in medium 1?

E. If $n_1 = 1.7$, $\theta_1 = 40^\circ$, and $\theta_2 = 65^\circ$, what is the speed of light in medium 2?

Reflection, Refraction, and Dispersion

6. A ray of light is incident from air on the upper surface of two parallel-sided slabs of transparent material, as shown.
- A. What is the angle of refraction ϕ in the lower slab?

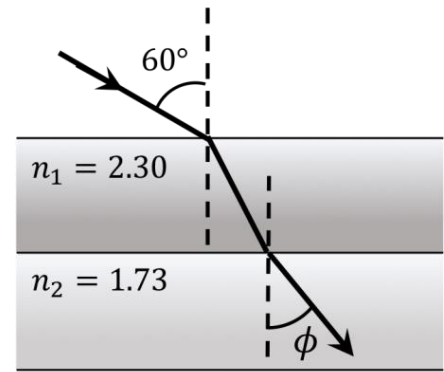

- B. How would ϕ change if you doubled n_1 ?

7. In a fish tank filled with water ($n = 1.33$), a light ray is directed towards the surface at an angle θ such that no light enters the air above the tank and the refracted light is parallel to the surface of the water.

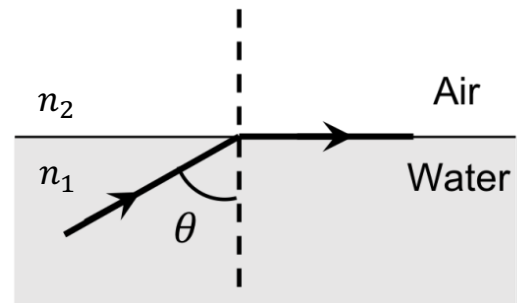

- A. What is the critical angle needed to fulfill this condition?

- B. What happens to the ray when it hits the water-air interface at an angle that is greater than θ ?

- C. Suppose we place a glass plate ($n_3 = 1.5$) on top of the water, as shown. Does adding the glass plate change the critical angle?

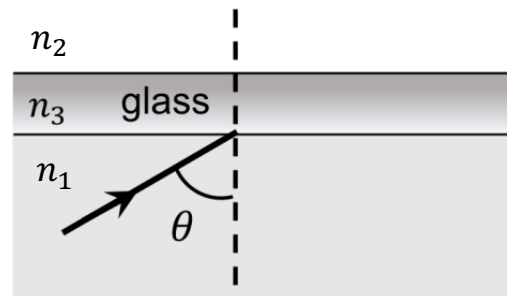

- D. What happens to the incident light ray (still with the same angle of incidence you computed in part A) when it hits the new water-glass interface? Draw the ray in the diagram to the right and calculate the angle of refraction.
- E. What will happen to the refracted ray when it passes through the glass plate and reaches the glass-air interface? Draw the ray on the diagram above and calculate the angle of refraction.
- F. Suppose a different light ray is incident on the water-glass interface from below at an angle of 30° to the normal of the surface. What is the final angle of refraction of the ray after passing through the glass plate and entering the air?
- G. What happens to this angle if we use a different kind of glass plate with index of refraction 1.9?
- H. Although a fraction of the incident light is refracted, another fraction of the light is reflected at the water-glass interface. What is the angle between this reflected ray (in water) and the refracted ray (in air)?

Interference

Group Questions

1. When there is destructive interference between two light waves at a point in space, why does it appear dark?
 - a) Because the troughs of both waves are always lined up.
 - b) Because the intensities of both waves are zero.
 - c) Because the light bends around that point in space.
 - d) Because the E- and B-fields of both waves cancel each other out.
 - e) Because there is no phase difference between the waves
2. The figure below shows the interference patterns produced by monochromatic light passing through single slits of four different widths. In which case does the slit have the smallest width?

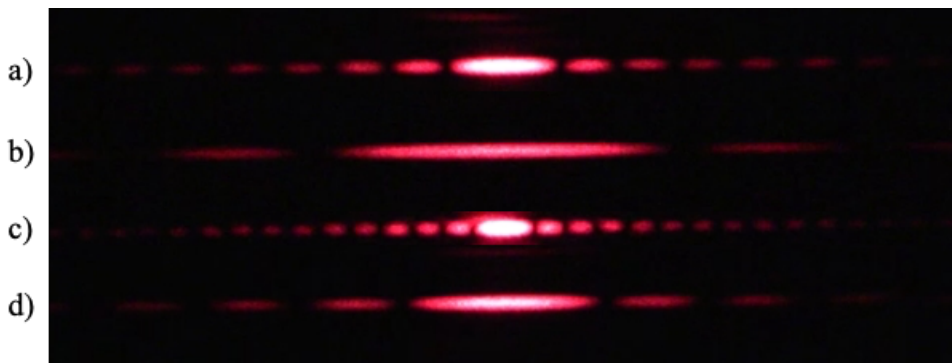

3. A double-slit experiment is performed with three different colors of light: red, green, and blue. Rank the colors by the distance between adjacent bright fringes, from largest to smallest.
 - a) blue > green > red
 - b) red > blue > green
 - c) red > green > blue
 - d) The fringe separation will be the same for each.
 - e) We can't tell unless we know the slit separation.

Interference

Useful expressions

Double-slit interference

(also applies to diffraction gratings)

$$\Delta pl = d \sin \theta_{\text{bright}} = m\lambda$$

$$y_{\text{bright}} = \frac{\lambda L}{d} m \quad m = 0, \pm 1, \pm 2, \dots$$

$$\Delta pl = d \sin \theta_{\text{dark}} = (m + 1/2)\lambda \quad y_{\text{dark}} = \frac{\lambda L}{d} (m + 1/2) \quad m = 0, \pm 1, \pm 2, \dots$$

Single-slit interference (diffraction)

$$\sin \theta_{\text{dark}} = m \frac{\lambda}{w} \quad m = \pm 1, \pm 2, \dots$$

Optical resolution

$$\sin \theta_R = 1.22 \frac{\lambda}{D}$$

Exercises

4. The image at right shows the viewing screen in a double-slit experiment. For parts A-C, will the fringe spacing *increase*, *decrease*, or *stay the same*? Explain your answer in each case.



A. The distance to the screen is increased.

B. The spacing between the slits is increased.

C. The wavelength of the light is increased.

D. Suppose the wavelength of the light is 500 nm. The point on the screen marked with a dot is how much further from the left slit than from the right slit?

5. The picture below shows two sources of light waves that are interfering. The thick lines represent wave peaks (*i.e.*, where the E- and B-fields are maximum in one direction). The thin lines represent wave troughs (*i.e.*, where the E- and B-fields are maximum in the opposite direction).

- A. Which of the numbered points represent locations of constructive interference?

- B. For each of the points above, determine the path length (in terms of λ) from each source. Then compute the path length difference.

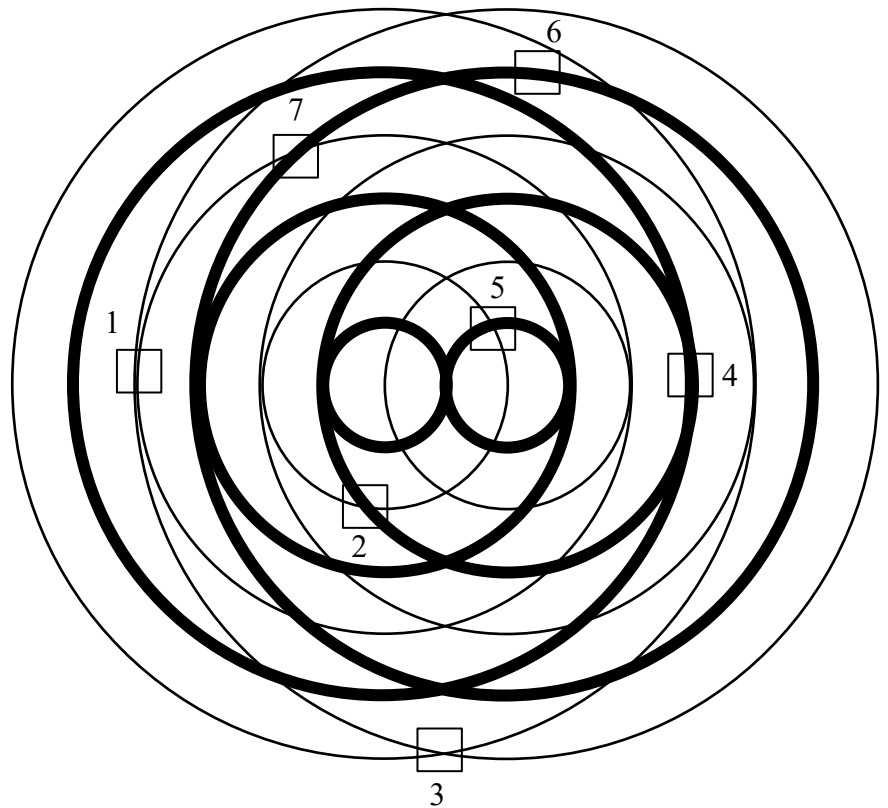

- C. Which of the numbered points represent locations of destructive interference?

- D. For each of the points above, determine the path length (in terms of λ) from each source. Then compute the path length difference.

- E. Are there any points at which neither constructive nor destructive interference is occurring? What would you see if you placed a screen at those points?

Interference

6. The limit to the eye's acuity, or ability to resolve fine details a distance, is related to diffraction by the pupil.
- A. What is the angle between two just-resolvable points of light for a 3-mm diameter pupil, assuming an average wavelength of 550 nm?

 - B. Take your result to be the practical limit for the eye. What is the greatest possible distance a car can be from you if you can resolve its two headlights, given they are 1.3 m apart?

 - C. What is the distance between two just-resolvable points held at arm's length (0.8 m) from your eye?

 - D. How does your answer to C compare to details you normally observe in everyday circumstances?

 - E. If you want to maximize your ability to distinguish two points, what kind of light should you use to illuminate them?

Interference

7. You shine monochromatic light of frequency 6×10^{14} Hz through two small slits separated by 2×10^{-4} m. You set up a screen 4 m away to observe the interference pattern.
- A. What is the path length difference between light from the two slits to the central bright fringe?
- B. What is the path length difference between light from the two slits to the first dark fringe? At what angle with respect to the center line does this fringe occur?
- C. What is the path length difference between light from the two slits to the third ($m = 3$) bright fringe? How far away is this fringe from the central bright fringe on the screen?

Interference

8. Match the structure of points (for instance, atoms) with the light pattern that would be produced if x-rays were passed through that structure. (*Note: Each point will behave as a source of light and the light patterns will be the product of both diffraction and interference.*)

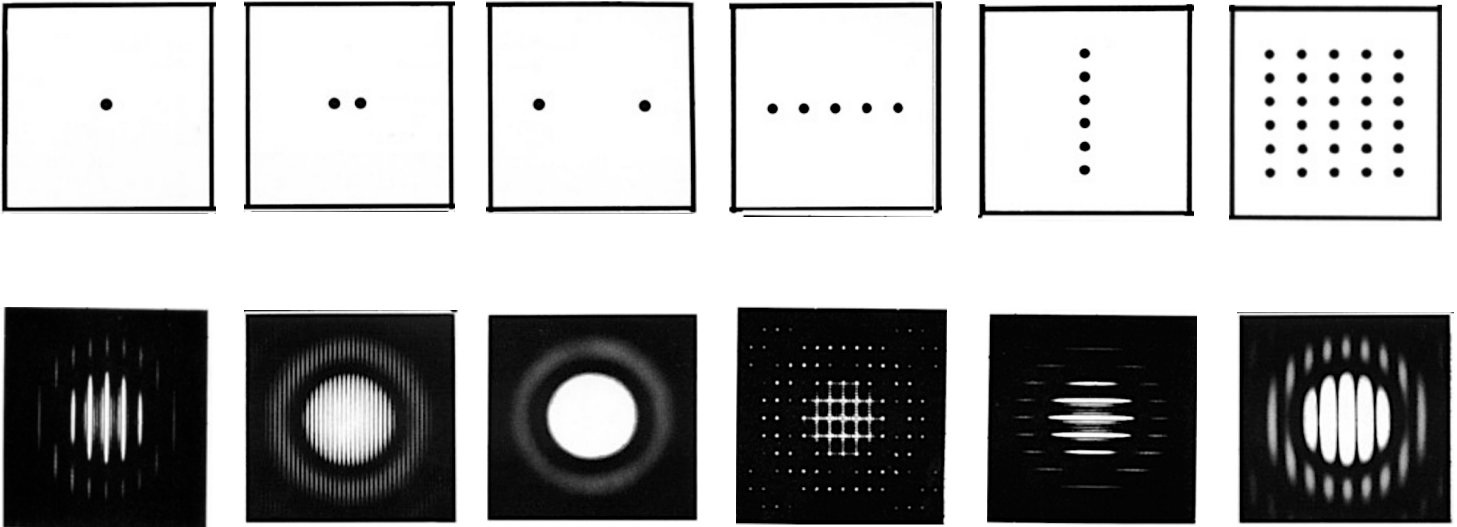

Thin Film Interference and Interferometry

Group Questions

1. In which of the following ways can you create a phase difference between two monochromatic coherent beams of light? (Select all that apply.)
 - a) Reflect one beam off a surface with a lower index of refraction.
 - b) Change the intensity of one of the beams.
 - c) Make one beam travel a different distance than the other.
 - d) Reflect one beam off a surface with a higher index of refraction.
 - e) Reflect both beams off a mirror.

2. An unknown film floating on water ($n_{\text{water}} = 1.33$) appears dark at its edges where it has the least thickness. You know this is due to thin film interference, but the thickness is almost zero; there must be a phase shift in one of the two reflections. You conclude that the index of refraction of the unknown film must be:
 - a) Less than 1.33
 - b) Greater than 1.33
 - c) Equal to 1.33

3. Two parallel microwaves, initially in phase and having a 3 cm wavelength, reach a detector after one of the waves passes through a 9 cm long block of glass with an index of refraction $n = 1.5$. (The situation is sketched at right, although not to scale.) Upon reaching the detector, the two waves will be:
 - a) Still in phase
 - b) Completely out of phase
 - c) Neither of the above

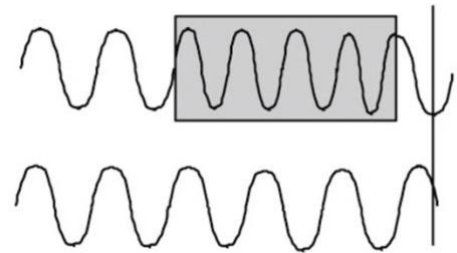

Useful expressions

$$\lambda_n = \frac{\lambda}{n}$$

Hard reflection: $\frac{\lambda}{2}$ phase shift

Soft reflection: no phase shift

Thin film interference

$$2nt = (m + 1/2)\lambda$$

$$2nt = m\lambda$$

$$m = 0, 1, 2, \dots$$

Exercises

4. We have two expressions for the conditions of constructive and destructive interference for light reflected from a thin film. To determine which to use in different situations, circle the correct expression in each cell of the table below.

	This expression gives the conditions of constructive interference in the specified situation.	This expression gives the conditions of destructive interference in the specified situation.
When there is one hard and one soft reflection.	$2nt = (m + 1/2)\lambda$ $2nt = m\lambda$	$2nt = (m + 1/2)\lambda$ $2nt = m\lambda$
When there are two hard reflections or two soft reflections.	$2nt = (m + 1/2)\lambda$ $2nt = m\lambda$	$2nt = (m + 1/2)\lambda$ $2nt = m\lambda$

5. The diagram shows four situations in which light of wavelength λ is incident perpendicularly on a very thin layer (the middle layer in each case). The indices of refraction are $n_1 = 1.5$ and $n_2 = 2.0$.

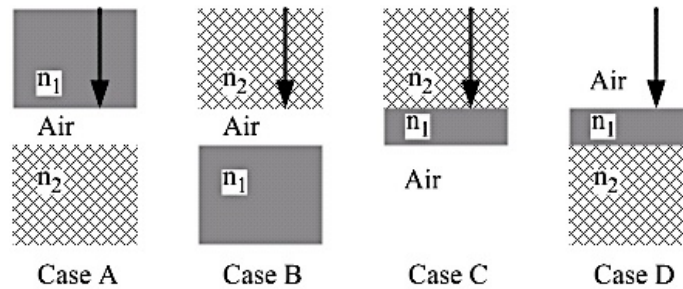

- A. For each case, state whether the light reflected back up will be **bright** (due to constructive interference) or **dark** (due to destructive interference) in the limit that the middle layer approaches zero thickness. (*i.e.*, we're going to assume that all phase shifts are due only to reflections and not to path length differences. Note that you don't have to worry about determining whether to account for path length difference or not on your own. We'll always tell you whether you need to or not).

Case A:

Case B:

Case C:

Case D:

- B. In Case B, what is the minimum non-zero thickness of the thin film that would produce **destructive** interference for reflected light if the wavelength of the incident light is 600 nm (measured in air). (In other words, we are NOT ignoring thickness and phase differences due to path length here. Note that ignoring a piece of a problem and then adding it in later is a common approach to complicated problems in physics.)

6. Many instances of vibrant color in biology are due to thin-film interference. For instance, consider a transparent segment of a dragonfly's wing. It is 94.2 nm thick and is surrounded by air ($n = 1$) on both sides. The wing is made of a material with index of refraction 1.3.

A. Sketch the wing and draw the two rays that will be interfering. Label them 1 and 2.

- B. Indicate whether either (or both) of the rays undergo a phase shift upon reflection. Given your conclusion, circle the correct equation that describes the conditions for constructive interference.

$$2nt = (m + 1/2)\lambda$$

$$2nt = m\lambda$$

- C. Use the equation you chose to solve for the wavelengths that will be most strongly reflected.

- D. What visible wavelength is most strongly reflected? Use the table at right to determine what color the wing mostly appears.

Red	620 – 750 nm
Orange	590 – 620 nm
Yellow	570 – 590 nm
Green	495 – 570 nm
Blue	450 – 495 nm

- E. In part D, you needed to assume $m = 0$ to find an answer. What if m was equal to something else? What does it mean when m equals a number other than 0?

7. The diagram at right shows a Michelson interferometer, which is an important application of flat mirrors. The interferometer allows precision measurements of wavelengths, distances, and other quantities.

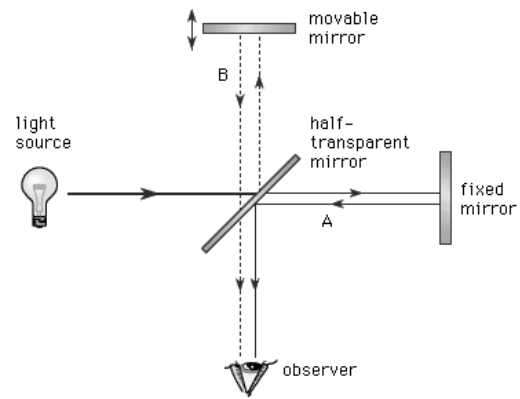

- A. If you displace the movable mirror a distance d , by how much do you change the path length difference between the two arms?
- B. Do we need to consider differences in phase due to reflection between each arm of the interferometer? Why or why not?
- C. As the movable mirror is displaced, the observed interference pattern will undergo some number of “fringe shifts” as it moves between instances of constructive and destructive interference. Suppose N fringe shifts are observed when the mirror is translated a distance d . Write an equation relating N , d and λ . (*Hint*: Each fringe shift represents the interference pattern cycling from one instance of constructive interference to the next.)
- D. Suppose the movable mirror is displaced 0.382 mm, causing 1700 fringe shifts to be observed. What is the wavelength of the laser? What color is it?

8. An inventor has an idea to make aircraft invisible to radar by coating them with a thin layer of material with an index of refraction $n = 1.20$, which is between that of air and the surface of the plane. The inventor reasons that this solution should be much cheaper than designing conventional stealth aircraft. You have been hired to evaluate the inventor's claims.

A. What thickness of material is necessary to inhibit the reflection of 4.00-cm wavelength radar waves?

B. What is unreasonable about this result?

Mirrors

Group Questions

1. The image formed by a single plane mirror is: (Select all that apply)
 - a) Real
 - b) Virtual
 - c) Inverted
 - d) Upright
 - e) All of the above

2. In which case is an image not formed by a concave mirror?
 - a) When the object is at the radius of curvature.
 - b) When the object is at the focal point.
 - c) When the object distance is twice the focal length.
 - d) When the object is closer than the focal point.
 - e) When the object is further away than the focal point.

3. When drawing a ray diagram for a concave mirror, which ray would you not want to include?
 - a) The ray that starts out horizontal and then is reflected back through the focal point.
 - b) The ray that goes through the focal point and ends up horizontal (if the object is further away from the mirror than the focal point).
 - c) The ray that starts out horizontal and then is reflected back through the point of the radius of curvature (if the object is further away than twice the focal length from the mirror)
 - d) The ray that reflects off the center of the mirror.
 - e) The ray that appears to come from the focal point and ends up horizontal (if the object is closer to the mirror than the focal point).

Mirrors

Useful expressions

$$\frac{1}{d_o} + \frac{1}{d_l} = \frac{1}{f}$$

$d_l > 0$ for real image

$$m = \frac{h_l}{h_o} = -\frac{d_l}{d_o}$$

$d_l < 0$ for virtual image

$f > 0$ for concave mirror

$f < 0$ for convex mirror

$f = \infty$ for plane mirror

Exercises

4. Your eye is located a distance $d = 20$ cm from a vertical arrow of height $h = 10$ cm, which in turn is a distance $d = 20$ cm from a plane mirror as shown.

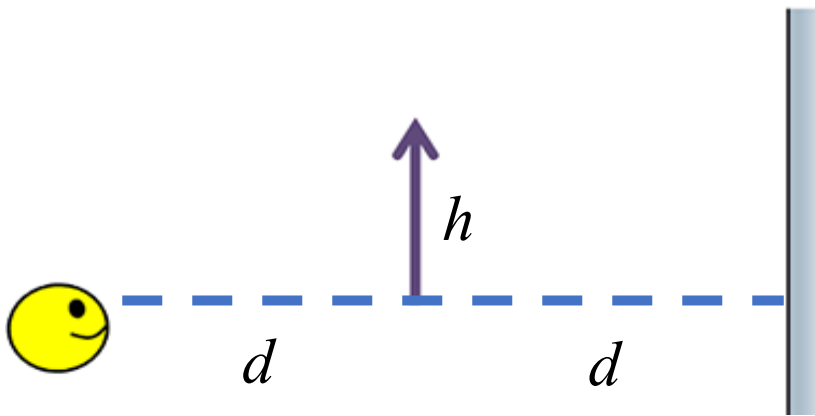

- A. Draw rays to locate the image of the arrow.
- B. What is the *lateral magnification* of the image?
- C. As seen from your eye, what is the *angular magnification* of the image compared to the object? You will read about angular magnification next week when we discuss optical instruments. It is defined to be the ratio of the angle subtended by the image to the angle subtended by the object.

Mirrors

- D. Evaluate this statement: “Since the image of an object in a plane mirror always appears twice as far away as the object itself, the magnification of a flat mirror is less than one. (That is, plane mirrors make things appear smaller.)”

5. Consider an object in front of a concave mirror as shown. The solid dot is the focal point of the mirror. The open dot is the center of the radius of curvature.

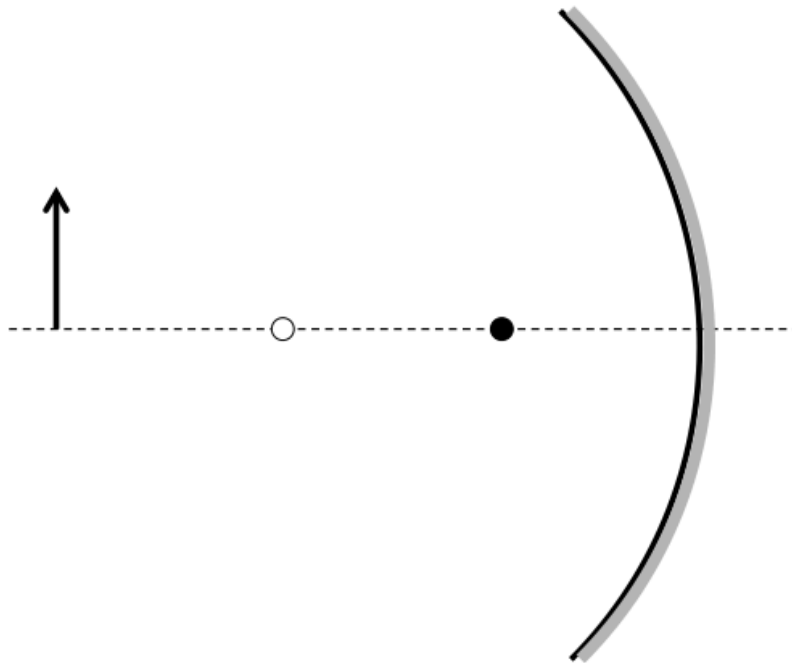

- A. Draw a ray diagram to find the location and lateral magnification of the image.
- B. If $d_o = 6$ cm and $f = 2$ cm, what is d_i ?
- C. If the height of the object is 1.8 cm, what is the image height? What is the lateral magnification of the image?

D. How do these two calculations compare with the diagram you drew in A?

6. Consider an object in front of a concave mirror as shown. Once again, the solid dot is the focal point of the mirror. The open dot is the center of the radius of curvature.

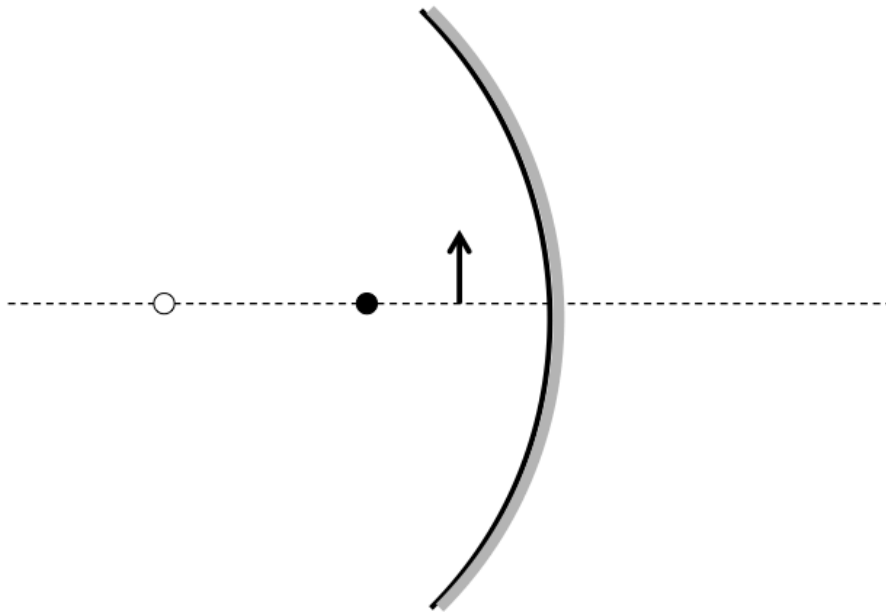

A. Draw a ray diagram to find the location and lateral magnification of the image.

B. If $d_o = 0.5$ cm and $f = 1$ cm, what is d_i ?

C. If the height of the object is 1 cm, what is the lateral magnification of the image?

D. How do these two calculations compare with the diagram you drew in A?

7. Draw a ray diagram to find the location and magnification of the object shown in front of a convex mirror.

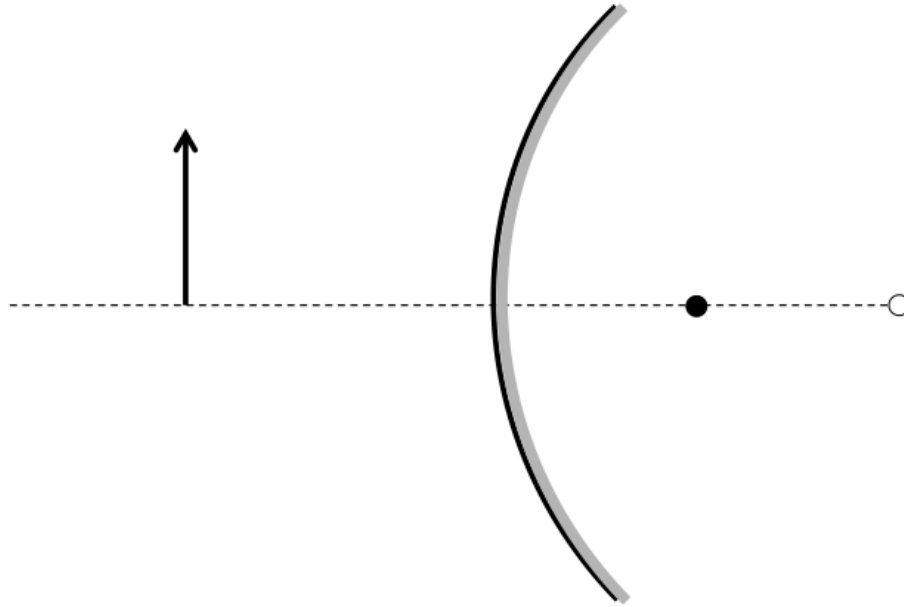

A. If $d_o = 3$ cm and $f = -2$ cm, what is d_i ?

B. What is the lateral magnification of the image?

C. How do these values compare with your ray diagram?

Lenses

Group Questions

1. What does it mean when an optical component (*i.e.*, a mirror or lens) has a negative focal length? (Select all that apply.)
 - a) The image will always be inverted.
 - b) The focal point doesn't exist.
 - c) Light leaving the mirror or lens will always be spreading out.
 - d) The image will always be virtual.
 - e) It is impossible to have a negative focal length.

2. Which of the following is true about the differences between real and virtual images? (Select all that apply.)
 - a) A real image appears 3-dimensional. A virtual image does not.
 - b) A real image can be projected onto a screen. A virtual image cannot.
 - c) A real image formed by a lens is always on the opposite side of the lens from the object. A virtual image is always on the same side of the lens as the object.
 - d) Light from a real image is actually passing through the location of that image. Light from a virtual image only *appears* to come from the location of the image.
 - e) A real image is always upright. A virtual image is always inverted.

3. A single diverging lens will always produce a _____ image.
 - a) Virtual, upright, smaller
 - b) Real, inverted, smaller
 - c) Real, inverted, larger
 - d) Virtual, upright, larger
 - e) Virtual, inverted, smaller

Useful expressions

$$\frac{1}{d_o} + \frac{1}{d_i} = \frac{1}{f}$$

$d_i > 0$ for real image

$f > 0$ for converging lens

$$m = \frac{h_i}{h_o} = -\frac{d_i}{d_o}$$

$d_i < 0$ for virtual image

$f < 0$ for diverging lens

Exercises

4. A 2 cm tall object is placed 6 cm from a converging lens with a focal length of 2 cm.

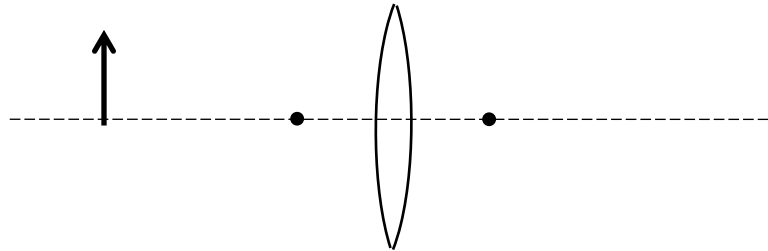

- A. Draw a ray diagram to locate the image using all three of the principal rays.
- B. Using your ray diagram, estimate the image distance and magnification.
- C. Using the lens equation, calculate the image distance and magnification and compare to the results from your diagram.

- D. The image in this case is:

Upright

Inverted

Real

Virtual

Larger than the object

Smaller than the object

5. A 2 cm tall object is placed 3 cm from a converging lens with a focal length of 4 cm.

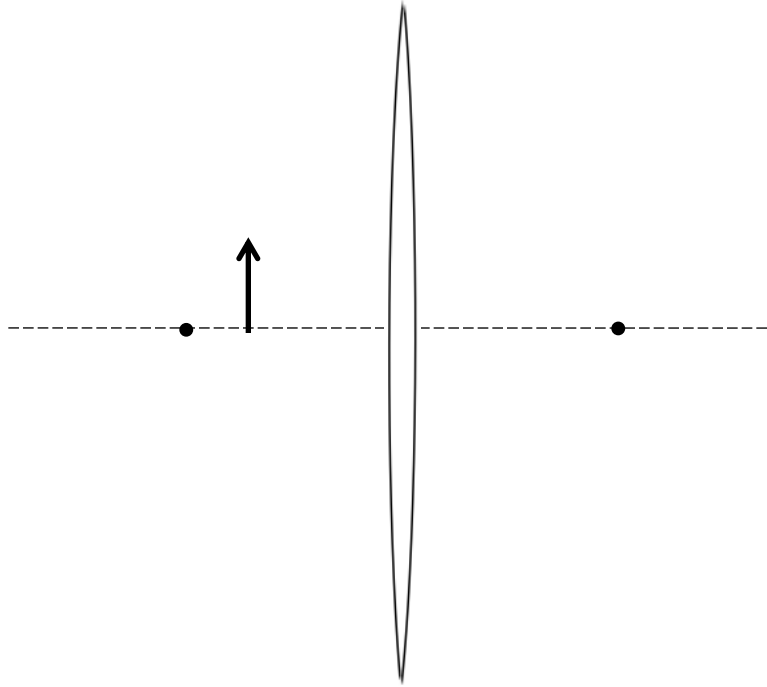

- A. Draw a ray diagram to locate the image using all three of the principal rays.
- B. Using your ray diagram, estimate the image distance and magnification.
- C. Using the lens equation, calculate the image distance and magnification and compare to the results from your diagram.

- D. The image in this case is:

Upright

Inverted

Real

Virtual

Larger than the object

Smaller than the object

6. A 2 cm tall object is placed 4 cm from a diverging lens with a focal length of -6 cm.

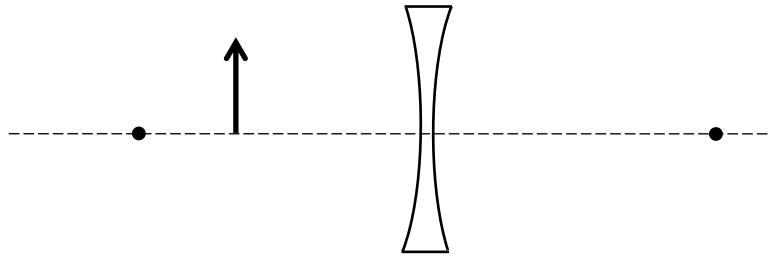

- A. Draw a ray diagram to locate the image using all three of the principal rays.
- B. Using your ray diagram, estimate the image distance and magnification.
- C. Using the lens equation, calculate the image distance and magnification and compare to the results from your diagram.

D. The image in this case is:

Upright

Inverted

Real

Virtual

Larger than the object

Smaller than the object

7. When you solve the lens equation for image distance, you get $d_i = \frac{d_o f}{d_o - f}$

Use this and your answers to the previous questions to complete the following table:

<p>Flat Mirror</p> <p>When an object is any distance from a flat mirror, we get a</p> <table border="1"> <tr> <td>real</td> <td>upright</td> <td rowspan="2">image.</td> </tr> <tr> <td>virtual</td> <td>inverted</td> </tr> </table>	real	upright	image.	virtual	inverted	<p>Flat Glass</p> <p>When an object is any distance from a flat slab of glass, we get a</p> <table border="1"> <tr> <td>real</td> <td>upright</td> <td rowspan="2">image.</td> </tr> <tr> <td>virtual</td> <td>inverted</td> </tr> </table>	real	upright	image.	virtual	inverted
real	upright	image.									
virtual	inverted										
real	upright	image.									
virtual	inverted										
<p>Concave Mirror</p> <p>When an object is between very far away and the mirror's focal length, we get a</p> <table border="1"> <tr> <td>real</td> <td>upright</td> <td rowspan="2">image.</td> </tr> <tr> <td>virtual</td> <td>inverted</td> </tr> </table>	real	upright	image.	virtual	inverted	<p>Converging Lens</p> <p>When an object is between very far away and the lens's focal length, we get a</p> <table border="1"> <tr> <td>real</td> <td>upright</td> <td rowspan="2">image.</td> </tr> <tr> <td>virtual</td> <td>inverted</td> </tr> </table>	real	upright	image.	virtual	inverted
real	upright	image.									
virtual	inverted										
real	upright	image.									
virtual	inverted										
<p>When an object is between the mirror's focal length and the mirror's surface, we get a</p> <table border="1"> <tr> <td>real</td> <td>upright</td> <td rowspan="2">image.</td> </tr> <tr> <td>virtual</td> <td>inverted</td> </tr> </table>	real	upright	image.	virtual	inverted	<p>When an object is between the lens's focal length and the lens's surface, we get a</p> <table border="1"> <tr> <td>real</td> <td>upright</td> <td rowspan="2">image.</td> </tr> <tr> <td>virtual</td> <td>inverted</td> </tr> </table>	real	upright	image.	virtual	inverted
real	upright	image.									
virtual	inverted										
real	upright	image.									
virtual	inverted										
<p>Convex Mirror</p> <p>When an object is between very far away and the mirror's focal length, we get a</p> <table border="1"> <tr> <td>real</td> <td>upright</td> <td rowspan="2">image.</td> </tr> <tr> <td>virtual</td> <td>inverted</td> </tr> </table>	real	upright	image.	virtual	inverted	<p>Diverging Lens</p> <p>When an object is between very far away and the lens's focal length, we get a</p> <table border="1"> <tr> <td>real</td> <td>upright</td> <td rowspan="2">image.</td> </tr> <tr> <td>virtual</td> <td>inverted</td> </tr> </table>	real	upright	image.	virtual	inverted
real	upright	image.									
virtual	inverted										
real	upright	image.									
virtual	inverted										
<p>When an object is between the mirror's focal length and the mirror's surface, we get a</p> <table border="1"> <tr> <td>real</td> <td>upright</td> <td rowspan="2">image.</td> </tr> <tr> <td>virtual</td> <td>inverted</td> </tr> </table>	real	upright	image.	virtual	inverted	<p>When an object is between the lens's focal length and the lens's surface, we get a</p> <table border="1"> <tr> <td>real</td> <td>upright</td> <td rowspan="2">image.</td> </tr> <tr> <td>virtual</td> <td>inverted</td> </tr> </table>	real	upright	image.	virtual	inverted
real	upright	image.									
virtual	inverted										
real	upright	image.									
virtual	inverted										

Optical Instruments

Group Questions

1. What should you do if you want to maximize the angular magnification of a magnifying glass?
 - a) Look at a very large object.
 - b) Look at a very small object.
 - c) Use a lens with a very long focal length.
 - d) Use a lens with a very large diameter.
 - e) Use a lens with a very short focal length.

2. Which of the following corresponds to the location of the image formed by the objective lens in a refracting telescope and in a microscope?

<u>Refracting telescope</u>	<u>Microscope</u>
a) Outside the focal length of the objective	Outside the focal length of the objective
b) At the focal length of the objective	At the focal length of the objective
c) Outside the focal length of the objective	At the focal length of the objective
d) At the focal length of the objective	Outside the focal length of the objective

3. An astronomical telescope has an objective lens with focal length f_o and an eyepiece with focal length f_e . A second telescope has an objective lens and eyepiece that each has double the focal length of the lenses in the first telescope. Which telescope has a greater magnification and by what factor?
 - a) The first telescope has a greater magnification by $2\times$.
 - b) The second telescope has a greater magnification by $2\times$.
 - c) Both telescopes have the same magnification.
 - d) The first telescope has a greater magnification by $4\times$.
 - e) The second telescope has a greater magnification by $4\times$.

Useful expressions

$$P = \frac{1}{f}$$

$$m_{\text{microscope}} = -\frac{L}{f_o} \left(\frac{25 \text{ cm}}{f_e} \right)$$

$$m_{\text{telescope}} = -\frac{f_o}{f_e}$$

$$m_{\text{angular}} = \frac{\theta_{\text{final}}}{\theta_{\text{initial}}} \approx \frac{d_{\text{initial}}}{d_{\text{final}}}$$

$$m_{\text{magnifier}} = \frac{25 \text{ cm}}{f}$$

Exercises

4. Consider the pair of lenses shown below.

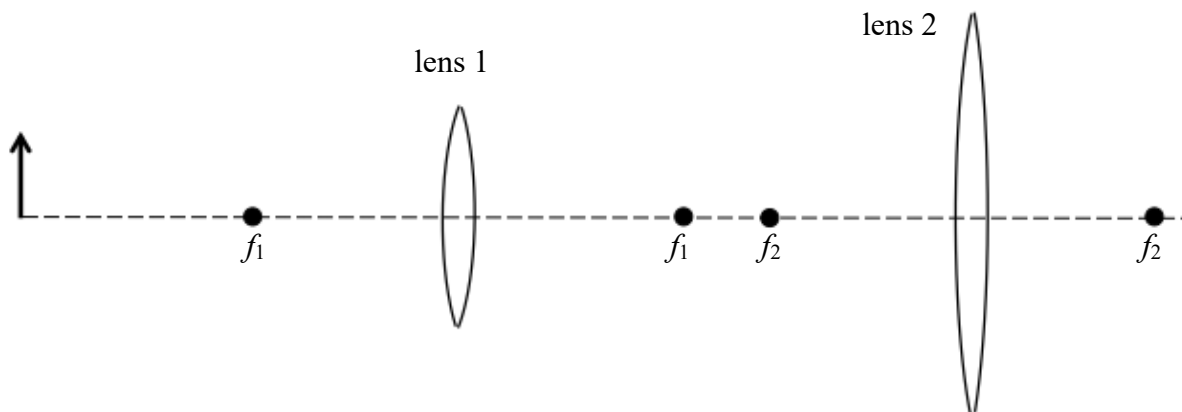

- Draw a ray diagram to locate the image produced by the first lens.
- Draw a second ray diagram to locate the image produced by the second lens, using the image produced by the first lens as your object.
- Assume that the object is 8 cm away from the first lens, which has a focal length $f_1 = 4$ cm. Calculate the position and magnification of the first image.
- If the second lens is 10 cm away from the first lens, how far is the first image from the second lens?

E. Assume that the second lens has a focal length f_2 of 4 cm. Calculate the position and magnification of the second image.

F. Would this instrument make a good microscope? Why or why not?

5. We can magnify objects using a simple magnifying glass, that is, a single converging lens. What advantage is gained by adding a second lens (the objective lens) to the simple magnifier (the eyepiece) to create a compound (that is, multi-lens) microscope?

6. We discussed in lecture that you want a long focal length (*i.e.*, fairly weak) lens as the objective of a telescope.

A. Use the following two diagrams of lenses to show why a long-focal-length lens will create larger images of distant objects than a lens with a short focal length.

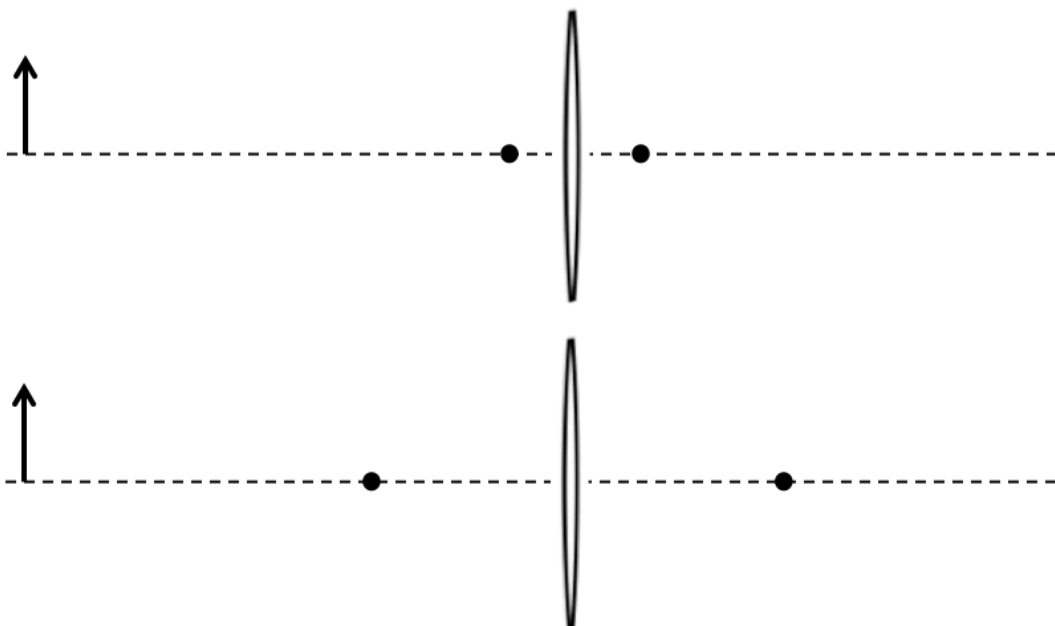

B. Explain what you've learned from these two diagrams in your own words. Is it consistent with the lens equation?

C. How does this conclusion explain why telescopes are usually so long?

7. You are building a compound microscope with an objective lens of focal length 0.7 cm and an eyepiece with focal length 5 cm. If you mount the two lenses at the opposite ends of a cylinder that is 18cm long, what is the approximate magnification of your scope?

8. Can you turn a microscope into a telescope by looking through it backwards without changing its physical dimensions?

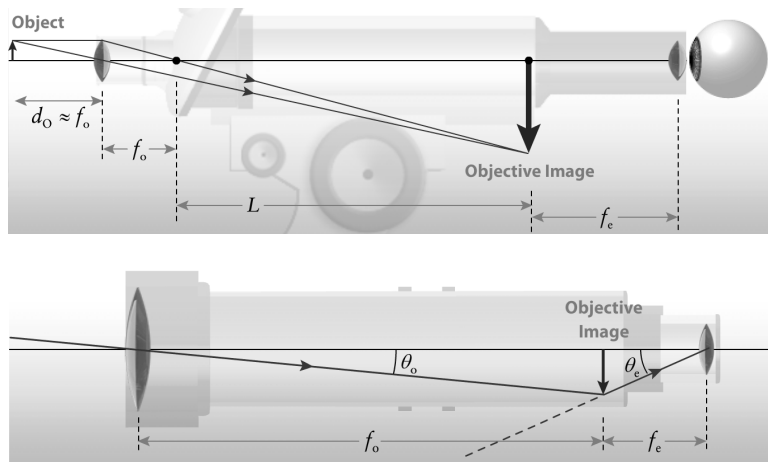

9. The first telescopes during the 1600s were composed of a converging objective lens and a diverging eyepiece. This combination produced an upright rather than an inverted image. However, to make such a telescope work, the objective lens must create an image on the *far side* of the eyepiece – that is, the object of the eyepiece is not a real object but rather a *virtual* one. In the same way that we trace rays back as if they had come from a virtual image when we draw ray diagrams, we must project rays forward as if they were heading toward a virtual object, then trace their path once they are intercepted by the lens. When doing calculations, a virtual object distance is always negative, just like a virtual image distance.

With this in mind, try calculating image distances and magnifications for the following system of lenses. You can assume the initial image distance from the objective lens is 3 cm, the focal length of the objective lens is 2 cm, the focal length of the eyepiece is -1 cm, and the distance between the two lenses is 4 cm.

After you've finished your calculation, see if you can draw the ray diagram for this setup.

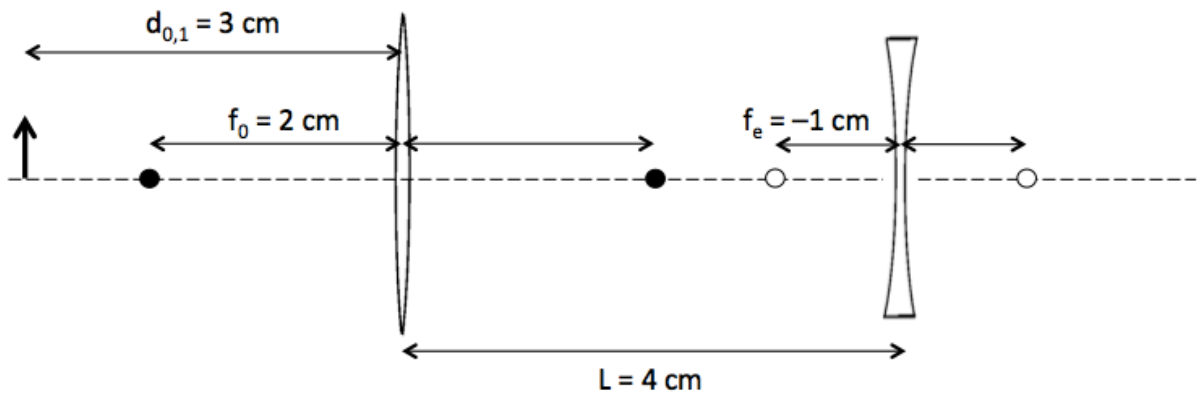

Vision and Polarization

Group Questions

1. Which of the following correctly describes the “near point” of the eyes?
 - a) The focal point of the eye when fully relaxed
 - b) The focal point of the eye when stretched, such as when squinting
 - c) The longest distance at which a person can see clearly
 - d) The shortest distance at which a person can see clearly
 - e) The smallest size of a circular dot, or point, that a person can see clearly

2. The lens of the eye adjusts its power when viewing objects at different distances, in a process called accommodation. What is the power of the eye when viewing an object 50 cm away? (Assume the distance between the lens and the retina is 2.0 cm.)
 - a) 2 diopters
 - b) 25 diopters
 - c) 50 diopters
 - d) 52 diopters
 - e) 100 diopters

3. An eye that is shorter than normal would result in what condition, and how could it be corrected?
 - a) Far-sightedness, which could be corrected using a converging lens
 - b) Near-sightedness, which could be corrected using a converging lens
 - c) Far-sightedness, which could be corrected using a diverging lens
 - d) Near-sightedness, which could be corrected using a diverging lens
 - e) None of the above

Useful expressions

$$\frac{1}{d_o} + \frac{1}{d_i} = \frac{1}{f}$$

$d_i > 0$ for real image

$$P = \frac{1}{f}$$

$$I = I_0 \cos^2 \theta$$

Exercises

4. The ray diagram below shows how light rays from a nearby object are refracted by a converging lens. Using this diagram, explain why a converging lens is used to correct far-sightedness.

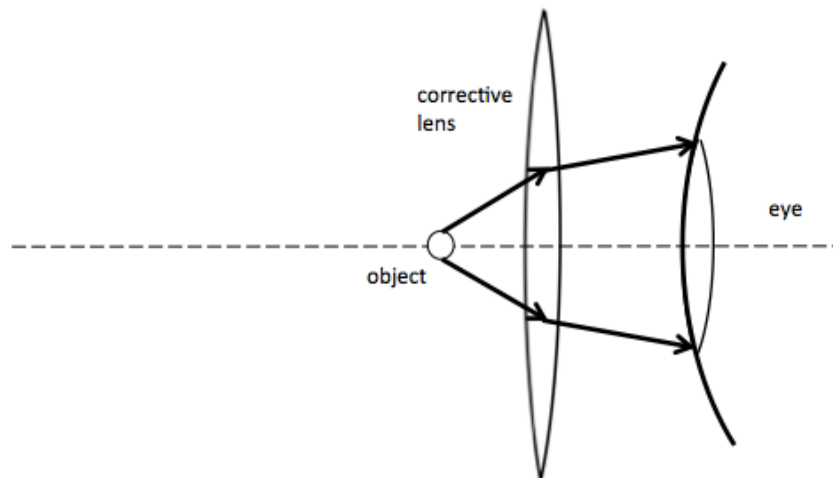

5. Now use the diagram below to explain why a diverging lens is used to correct near-sightedness. (This time, draw your own rays.)

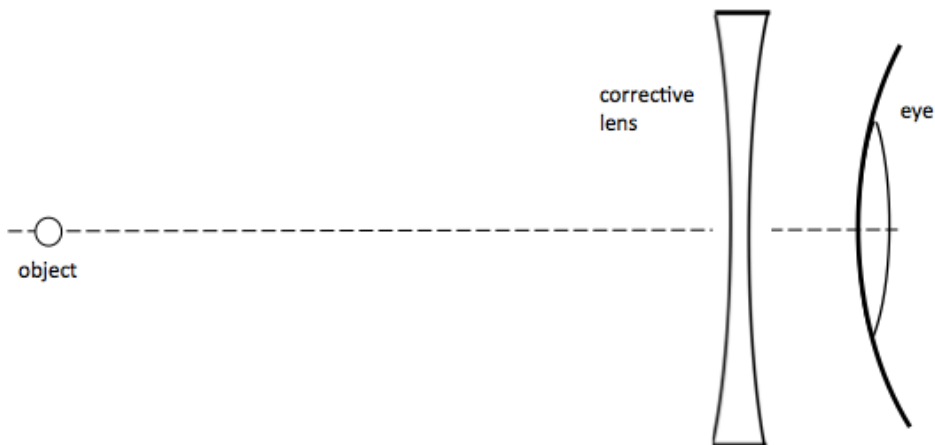

Vision and Polarization

6. A person sees clearly wearing eyeglasses that have a power of -4.00 diopters when the lenses are 2.00 cm in front of the eyes.
- A. What is the focal length of the lens?
- B. Is the person near-sighted or far-sighted?
- C. If the person wants to switch to contact lenses placed directly on the eyes, what lens power should be prescribed?

7. Imagine light incident on a series of three absorptive polarizers. The first has an axis of transmission oriented vertically. The second has an axis of transmission oriented at 30° from the vertical. The last has an axis of transmission oriented horizontally.

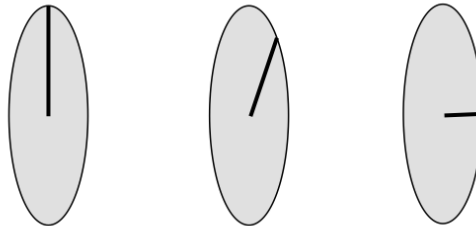

- A. If unpolarized light with intensity I_0 is incident on the first polarizer (the left-most one in the picture), what is the intensity of the light in terms of I_0 once it passes through but before it hits the second polarizer?
- B. What is the intensity of the light in terms of I_0 after the second polarizer?
- C. What is the intensity of the light in terms of I_0 after the third polarizer?

- D. What happens to the intensity of the light passing through the final polarizer if you rotate the middle polarizer so that it makes a 60° angle with the vertical?
- E. What happens to the intensity of the light passing through the final polarizer if you remove the middle polarizer? Explain your answer.
8. Suppose a farsighted person is unable to see anything clearly closer than 45 cm. You need to prescribe a lens for a pair of glasses they can wear. The distance between the person's eye and the lens will be 2 cm.
- A. If the person wants to clearly see an object with the glasses that is 20 cm away, what will the object distance be for the lens?
- B. How far away should the image created by the lens be away from the lens? (That is, what should be the image distance?)
- C. Is this a real or virtual image?
- D. What does the focal length of the lens need to be?
- E. What is the power of this lens in diopters?

9. The printed text in books is typically 3.50 mm in height. How high is the image of the print on the retina when the book is held 30.0 cm from the eye? Assume your eyeball has a diameter of 2 cm. (It may be helpful to sketch a diagram.)

Quantum Physics

Group Questions

1. Which of these photons has the most energy?
 - a) a photon of ultraviolet radiation
 - b) a photon of green light
 - c) a photon of yellow light
 - d) a photon of red light
 - e) a photon of infrared radiation

2. The color of light emitted by a hot object depends on:
 - a) the size of the object
 - b) the shape of the object
 - c) the material from which the object is made
 - d) the temperature of the object
 - e) the color of the object

3. Light is incident on a metal surface with photons of energy E_1 , and electrons are emitted from the surface. When the energy of the photons is changed to E_2 , no electrons are emitted. Which of the statements below must be true? (Select all that apply.)
 - a) E_2 is larger than E_1 .
 - b) E_2 is smaller than E_1 .
 - c) The work function of this metal is greater than E_2 .
 - d) The work function of this metal is greater than E_1 .
 - e) The work function of this metal is less than E_2 .

4. A particle's de Broglie wavelength depends only on:
 - a) the particle's mass
 - b) the particle's speed
 - c) the particle's energy
 - d) the particle's momentum
 - e) the particle's charge

Useful expressions

$$\lambda_{peak} = \frac{0.290 \text{ K} \cdot \text{cm}}{T}$$

$$K_{max} = hf - \phi_0$$

$$\lambda_{dB} = \frac{h}{p} = \frac{h}{mv}$$

$$E_{photon} = hf = \frac{hc}{\lambda}$$

$$h = 6.63 \times 10^{-34} \text{ J} \cdot \text{s} = 4.14 \times 10^{-15} \text{ eV} \cdot \text{s}$$

Exercises

5. The temperature of the Sun's surface is 5800 K.

A. Using Wien's displacement law, at what wavelength is the highest intensity?

B. What color does it correspond to? Use the graph shown at right. (wavelength is in nm).

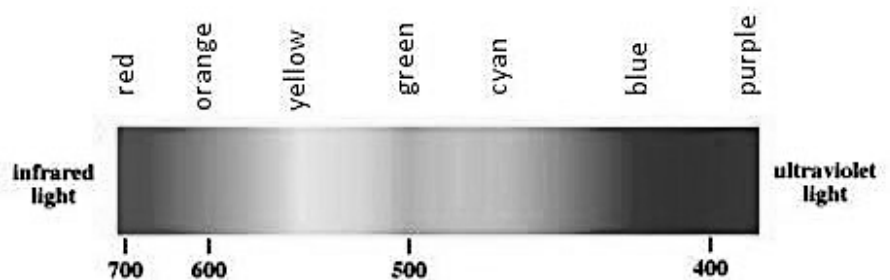

C. It is not accidental that the human eye is most sensitive to green light. Why?

D. In a distant future the Sun cools down to 4000 K. At what wavelength is the maximal intensity now?

- E. Which color does this wavelength correspond to?
- F. Assuming humans are around in the distant future, will we still be able to see the Sun with our eyes? Why or why not?
6. A beam of light with a wavelength of 62 nm is hitting the surface of an object. Electrons are emitted from this object with a maximum kinetic energy of 13.7 eV. We want to know what this object is made of.
- A. Let's break down this problem into multiple steps. What is the frequency of that light?
- B. What is the energy of a photon in this beam of light?
- C. Convert this energy from joules (J) to electron-volts (eV). (Remember that the charge on an electron is 1.6×10^{-19} C.)
- D. Some of this energy is used to "free" the electrons from the object (this is the work function of the material). The remaining energy of the photon becomes the kinetic energy of the emitted electron. If the kinetic energy of the emitted electron is 13.7 eV, what is the work function of the object?
- E. Using the table at right, what is the object made of?

Metal	Work function
Al	4.08 eV
Cu	4.70 eV
Fe	4.50 eV
Pt	6.35 eV

- F. What would happen if you increased the intensity of the light incident on this material but kept the wavelength the same?
7. In order to “see” an object, the wavelength has to be smaller than the object, which is also true for electron microscopes. If we want to see some details of a molecule, we need to use electrons that have a wavelength of 0.1 nm. (The mass of an electron is 9.1×10^{-31} kg.)
- A. With what voltage do we have to accelerate the electrons?
- B. If we keep the same voltage as before but use protons instead of electrons, what will be the wavelength of the protons? Does the resolution improve? (The mass of a proton is 1.7×10^{-27} kg.)
- C. Which of the following should you take away from this question?
- a) Electrons always have a longer wavelength than protons.
 - b) If velocity is the same, heavier objects will always have shorter wavelengths.
 - c) The wavelength of matter depends on what kind of microscope it's being used in.
 - d) A longer wavelength means you can see smaller objects.

8. Lead sulfide is a photoconductor, which operates on a variation of the photoelectric effect. Incident light of a certain wavelength will free up electrons enough so that they can move around, which can contribute to electric current, thus reducing the overall resistance of the material. Lead sulfide is often used in photodetectors because it responds well to near-infrared light.
- A. You determine that when you shine light of wavelength $3.4 \mu\text{m}$ on a piece of lead sulfide, you can easily get a current flowing through it. For light with wavelengths above $3.4 \mu\text{m}$, little or no current flows. What energy (in eV) do you need to free up electrons in lead sulfide?
- B. You continue to lower the wavelength of light you shine on the piece of lead sulfide. When you pass $1 \mu\text{m}$, you notice the resistance of the material increases once again. Why do you think this might be happening?
- C. If you place a plate of lead sulfide in a photoreceptor and aim a beam of light with a wavelength of $2 \mu\text{m}$ at it, you get maximum current. If the beam has an area of 0.001 m^2 and an intensity of 1 W/m^2 , how many electrons per second are you freeing up in the plate?

Atomic Spectra and Photon Emission

1. A red laser pointer and a green laser pointer are each rated at 2 mW. Which laser pointer produces more photons per second?
 - a) The red one produces more photons.
 - b) The green one produces more photons.
 - c) Both produce the same number of photons
2. Which of the following transitions will emit a photon with the shortest wavelength?
 - a) From $n = 4$ to $n = 3$
 - b) From $n = 3$ to $n = 1$
 - c) From $n = 2$ to $n = 1$
 - d) From $n = 4$ to $n = 1$
 - e) From $n = 3$ to $n = 2$

3. The figure shows part of the energy level diagram of a certain atom. The energy spacing between levels 1 and 2 is twice that between 2 and 3. If an electron makes a transition from level 3 to level 2, radiation of wavelength λ is emitted. What possible radiation wavelengths might be produced by other transitions between the three energy levels?

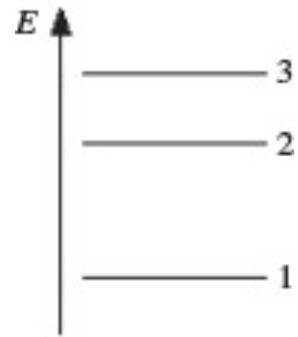

- a) Only 2λ
- b) Both $\lambda/2$ and $\lambda/3$
- c) Only $\lambda/2$
- d) Both 2λ and 3λ

Useful expressions

$$\frac{1}{\lambda} = R_H \left(\frac{1}{n_f^2} - \frac{1}{n_i^2} \right)$$

$$E_{\text{photon}} = hf = \frac{hc}{\lambda}$$

$$E_{\text{atom}} = -\frac{hcR_H}{n^2}$$

$$R_H = 1.097 \times 10^7 \text{ m}^{-1}$$

Exercises

4. We usually write the energy of a photon as $E = hf$, where $h = 6.626 \times 10^{-34}$ J s. But as you saw in lecture, when we are dealing with atoms and visible light it's more convenient to replace Joules by electron-volts (eV) and frequency by wavelength (using $f = c/\lambda$), measured in nanometers (nm). Let's develop an expression that you can carry around with you for these kinds of problems.
- A. Let's express the energy of the photon as $E = hc/\lambda$. Use the fact that the fundamental electric charge is $e = 1.602 \times 10^{-19}$ C and the speed of light is 2.998×10^8 m/s to show that the quantity hc can be written as $hc = 1240$ eV nm.
- B. Use your result to determine the energy, in eV, of a photon of green light with $\lambda = 550$ nm.

Atomic Spectra and Photon Emission

5. To the right is a model of an atom. (Note: This is not the hydrogen atom.) Assume that there are no other energy levels in this atom apart from the ones shown.

A. How many possible emission lines are there in this atom's emission spectrum?

_____ $E_4 = -0.5 \text{ eV}$

_____ $E_3 = -1.5 \text{ eV}$

_____ $E_2 = -4.5 \text{ eV}$

B. Calculate the wavelength of each emission line.

To identify each, use the notation $\lambda_{\text{initial,final}}$. (For instance, λ_{41} would be the wavelength of the photon emitted as an electron transition from the $n = 4$ level to the $n = 1$ level.)

_____ $E_1 = -10.5 \text{ eV}$

C. Sketch what the emission spectrum would look like below. Short wavelengths are to the left and long wavelengths are to the right.

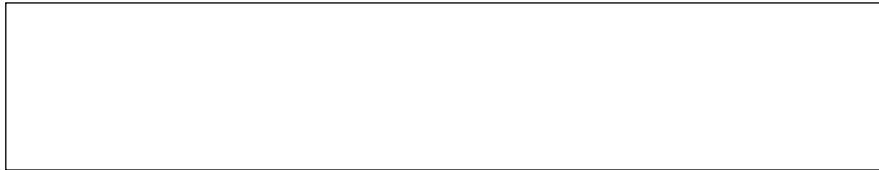

6. Suppose we have a mystery atom. The atom has an ionization energy (the energy required to completely remove an electron) equal to 4.1 eV. We also observe that the atom emits three spectral lines, at 310 nm, 400 nm, and 1378 nm.

A. What is the maximum wavelength of light that will completely strip the atom of an electron?

B. What is the energy of the photons in each of the three spectral emission lines?

Atomic Spectra and Photon Emission

- C. Use this information to sketch a picture of the electron energy levels of this atom. Assume that the higher energy levels are closer together. Also indicate which energy level is the ground state and label the transitions that result in each of the three spectral lines.
7. A student in a physics lab observes a hydrogen emission spectrum and finds the wavelength of a yellow line to be 589 nm.
- A. Assuming this is part of the Balmer Series (transitions with $n_f = 2$), determine the n of the initial level.
- B. What is unreasonable about this result?
- C. Where might the student have made a mistake or an unwarranted assumption? (Don't *just* mention mis-measuring the wavelength of the spectral line.)

8. Just as in atoms, there are also energy levels in molecules. Molecular energy levels are more complicated than atomic energy levels because the molecular levels are related to a combination of the electron energy levels of their constituent atoms *and* mechanical motions of the molecules and the atoms in them. For example, a sketch of the energy levels in the molecules used in a CO₂ laser are shown below. The atoms in the CO₂ molecule can *stretch* and *bend* the bonds that attach them to the other atoms. In this system these are metastable (long-lived) states. (See these nice animations here: https://scied.ucar.edu/sites/default/files/flash/ghg_molecules_vibrate.swf). In this type of laser a mixture of N₂ and CO₂ gas is placed in a cell. Light is brought into the cell that is absorbed by the N₂ molecules and excites them to energy levels above their ground level. The excited N₂ molecules then collide with the CO₂ molecules to excite them above their ground levels. The diagram shows some of the transitions that emit laser light. Roughly, what is the wavelength of the light emitted by a CO₂ laser? Would you be able to see it with your eyes?

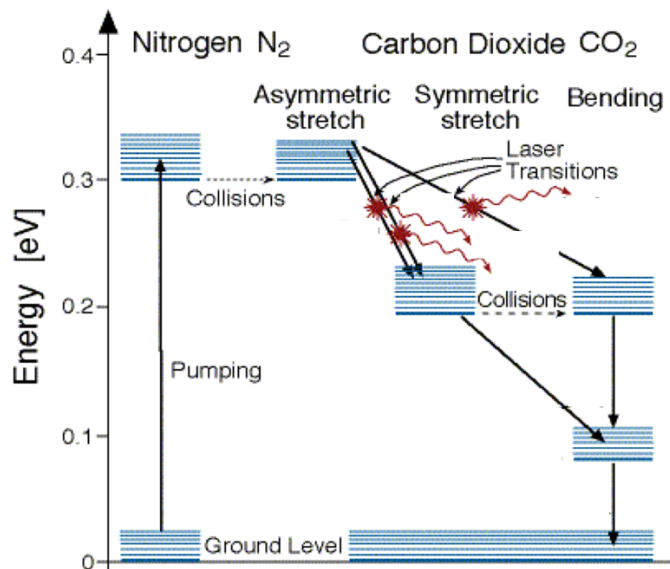

Atomic Physics

Group Questions

1. Which of the following statements regarding differences between the Bohr and Schrödinger models of the atom is not true?
 - a) In the Bohr model, ground state electrons can only ever be found at the Bohr radius, whereas in the Schrödinger model they can be found at a range of positions
 - b) The Bohr model cannot be applied to atoms with atomic numbers greater than 1, whereas the Schrödinger model can
 - c) The Bohr model cannot be applied to multi-electron atoms, whereas the Schrödinger model can
 - d) Electron orbitals in the Bohr model lie in a two-dimensional plane, whereas in the Schrödinger model they exist in three dimensions
 - e) The Bohr model is inconsistent with the Heisenberg uncertainty principle, whereas the Schrödinger model is consistent

2. An electron in an atom has quantum numbers $n = 5$ and $m_l = 3$. What are the possible values of l for this electron?
 - a) 0, 1, 2, 3, 4
 - b) 0, 1, 2, 3
 - c) 0, 1, 2
 - d) 3, 4, 5
 - e) 3, 4

3. The periodic table is based mainly on which of the following principles?
 - a) It is based on the uncertainty principle
 - b) All electrons in an atom must have the same set of quantum numbers
 - c) No two electrons in an atom can have the same set of quantum numbers
 - d) All electrons in an atom are in orbitals having the same energy
 - e) Energy is conserved in all interactions

Useful expressions

$$E_n = \frac{Z^2}{n^2} E_0$$

$$E_0 = -13.6 \text{ eV}$$

$$r_n = \frac{n^2}{Z} a_0$$

$$a_0 = 0.0529 \text{ nm}$$

$$n = 1, 2, 3, 4, \dots$$

$$l = 0, 1, 2, \dots, n - 1$$

Quantum numbers:

$$m_l = -l, -l + 1, \dots, l - 1, l$$

$$m_s = \pm 1/2$$

Exercises

4. Compare how much energy is required to excite an electron from the $n = 1$ state to the $n = 2$ state in hydrogen, singly ionized helium, and doubly ionized lithium according to the Bohr model. Then determine what wavelength of light would be required to cause each transition.

A. Use your calculations to fill in the following table:

	E_1 (eV)	E_2 (eV)	ΔE (eV)	λ (nm)
H ($Z = 1$)				
He ⁺ ($Z = 2$)				
Li ²⁺ ($Z = 3$)				

B. Consult the chart below to determine what type of EM radiation would cause these transitions.

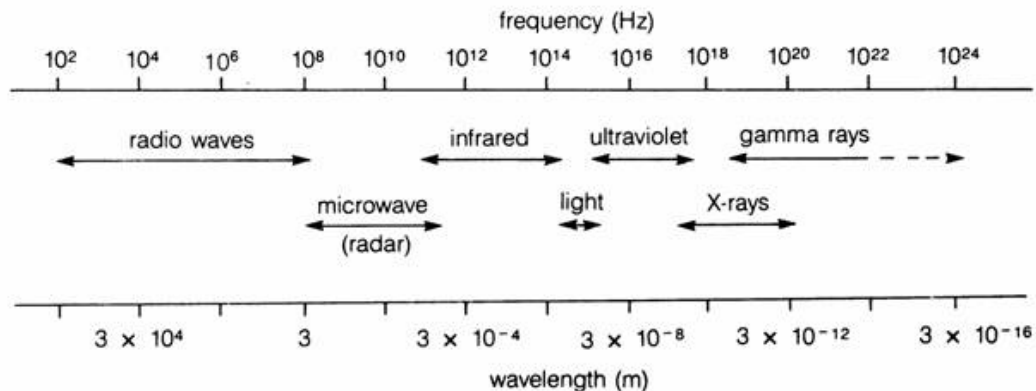

5. In modifying the Bohr model, Louis de Broglie assumed that confined electrons could be treated as waves and suggested that they could exist only in states where these waves form standing-wave patterns. An electron is in the second excited state of hydrogen, corresponding to $n = 3$.

A. What is the radius of the orbit?

B. What is the wavelength of the electron in this orbit? (*Hint:* The standing wave for a quantum number n must contain n complete wavelengths.)

C. Sketch the standing wave on the diagram below. Ensure that it has the correct number of full wavelengths.

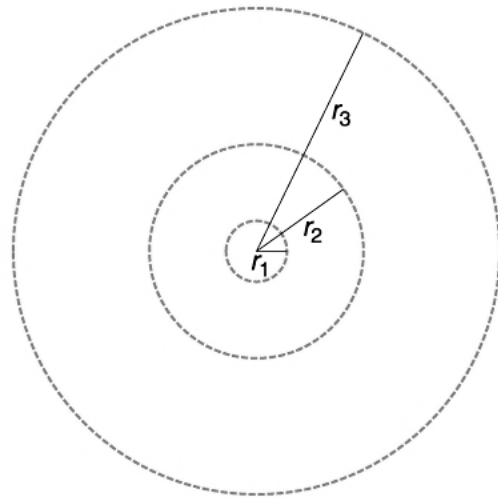

6. Which of the following could be a set of quantum numbers for an electron in the Schrodinger model of the atom? For each impossible set of quantum numbers, identify why it is impossible. For each possible set of quantum numbers, identify the atomic orbital (e.g., $1s$, $2p$) in which it resides.

a) $n = 3$ $l = 0$ $m_l = 0$ $m_s = 0$

b) $n = 4$ $l = 1$ $m_l = -1$ $m_s = +1/2$

c) $n = 0$ $l = 0$ $m_l = 0$ $m_s = -1/2$

d) $n = 1$ $l = 1$ $m_l = 0$ $m_s = +1/2$

e) $n = 2$ $l = 1$ $m_l = -2$ $m_s = +1/2$

f) $n = 3$ $l = 2$ $m_l = +2$ $m_s = -1/2$

7. Let's think a little more about the energy of an electron in the ground state of a hydrogen atom. We know its total energy is -13.6 eV. But where does this number come from?

A. The total energy of the electron will be its kinetic energy plus its electric potential energy. We'll start with the former. Find the kinetic energy of the electron in the ground state of hydrogen in eV. (*Hint:* You can find the velocity of the electron with this equation:

$$v = \frac{nh}{2\pi r_n m_e}. \text{ The electron mass is } m_e = 9.1 \times 10^{-31} \text{ kg.})$$

B. This number should be familiar, but we're not done yet. We haven't yet found the total energy of the electron. Is the energy you found in part A *positive* or *negative*?

- C. Find the potential energy of the electron in eV. (*Hint*: Recall the expression for the electric potential energy of two point charges.)
- D. Is the energy you found in part C *positive* or *negative*? (Be careful that you input the correct charge for the electron.)
- E. What is the total energy of the electron? What sign does it have?
- F. What is the significance of the total energy of the electron being negative?

Nuclear Physics

Group Questions

- Which of the following nuclei has a radius of $2r_0$?
 - Hydrogen-2
 - Helium-4
 - Beryllium-6
 - Boron-8
 - Carbon-10

- Why are large nuclei ($Z > 83$) typically unstable?
 - Such nuclei begin to get too heavy so that the force of gravity puts extreme stress on them.
 - At around 83 nucleons, the negatively charged neutrons begin to outnumber the positively charged protons.
 - Nuclei with $Z > 83$ contain too many electrons, which forces the neutrons apart.
 - At this size, the repulsive Coulomb force between protons becomes stronger than the attractive strong nuclear force between nucleons.

- Binding energy is... (Select all that apply)
 - the energy required to break a nucleus apart.
 - dependent on the kinetic energy of the nucleons.
 - the energy released when individual nucleons combine to form a stable nucleus.
 - not really energy at all.
 - only relevant for the hydrogen nucleus.

- In massive stars, three helium nuclei fuse together, forming a carbon nucleus. This reaction heats the core of the star. The net mass of the three helium nuclei must therefore be:
 - less than that of the carbon nucleus.
 - the same as that of the carbon nucleus because energy is always conserved.
 - higher than that of the carbon nucleus.
 - the same as that of the carbon nucleus because mass is always conserved.

Useful expressions

$$r = r_0 A^{1/3}$$

$$r_0 = 1.2 \text{ fm}$$

$$|E_B| = (Nm_n + Zm_{1H} - m_{atom})c^2$$

$$m_{1H} = 1.007825 \text{ u}$$

$$m_n = 1.008665 \text{ u}$$

$$u = \frac{931.494}{c^2} \text{ MeV}$$

Exercises

5. The figure to the right shows a graph of nuclides. The shaded region indicates all known nuclides, and the black dots indicate stable nuclides. The diagonal line indicates an equal number of protons and neutrons.

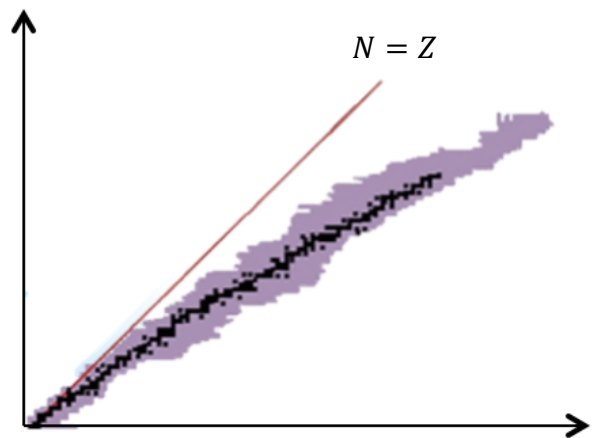

- A. Indicate which axis is the number of protons in each nucleus (Z).
- B. Indicate which axis is the number of neutrons in each nucleus (N).
- C. How did you make your choices in A and B?

D. As the nuclear size increases, why aren't more stable nuclei found along the diagonal line?

6. Complete the following table:

	Atomic mass	# of Protons	# of Neutrons	Radius	Total Binding energy	Binding energy per nucleon
${}^3\text{He}$	3.01603 u	2	1			
${}^4\text{He}$	4.00260 u	2	2			
${}^6\text{Li}$	6.01512 u	3	3			

- A. Which of these nuclei has the largest radius?
- B. Which of these nuclei has the greatest density?
- C. Which of these nuclei has the greatest binding energy per nucleon?
- D. Which of these nuclei is the most stable?

7. Below is a graph of binding energy per nucleon vs. the number of nucleons.

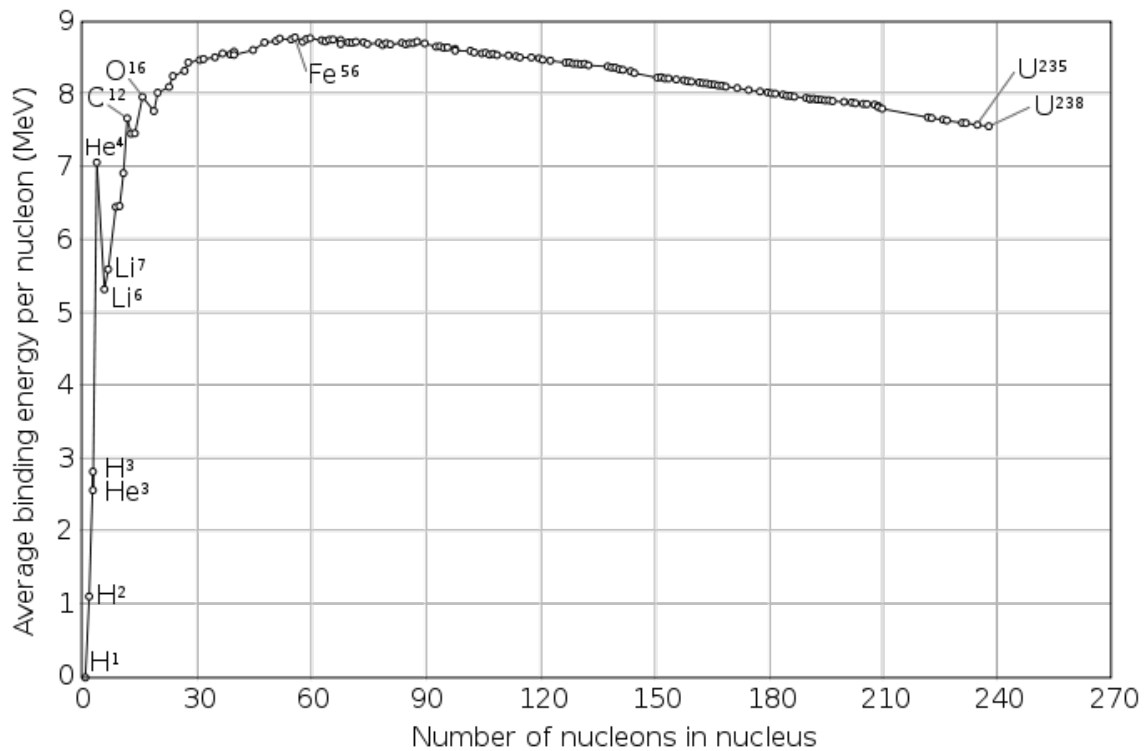

A. Which nucleus is more stable, ${}^7\text{Li}$ or ${}^{235}\text{U}$?

B. In the very early universe, shortly after the Big Bang, there was a short period of time when all matter was in the form of free protons and neutrons. Very quickly, a large fraction of these free nucleons formed into ${}^4\text{He}$, so much so that other elements were extremely rare. (Most of the elements around you today were formed in stars relatively recently, cosmologically speaking.) Can you explain why this happened?

C. Why do you think the vertical axis of the graph above is binding energy *per nucleon*. Why not just make a graph of total binding energy vs. nuclear size?

D. Assess the truth of the following statement: "It would require more energy to take apart a ^{235}U nucleus than it would to take apart a ^{16}O nucleus."

E. Assess the truth of the following statement: "Taking 238 nucleons and forming 34 ^7Li nuclei would result in a lower energy state than using those nucleons to form a single ^{238}U nucleus."

Fission, Fusion, and Nuclear Decay

Group Questions

- How is it possible that combining small nuclei into large nuclei can release energy?
 - The larger nucleus must be moving slower, and therefore excess kinetic energy is released into the environment.
 - The larger nucleus must have a larger binding energy, so it represents an overall lower energy state.
 - The smaller nuclei that undergo fusion must contain both particles and antiparticles that are annihilated when they meet.
 - The smaller nuclei must have larger binding energies than the larger nucleus they form, which results in the release of energy.
 - Nuclear fusion can never release energy – it consumes energy, as is the case inside the Sun.

- Which of the following is *not* a possible fission process?
 - $^{235}\text{U} \rightarrow ^{140}\text{Xe} + ^{92}\text{Sr} + 3\text{n}$
 - $^{235}\text{U} + \text{n} \rightarrow ^{143}\text{Ba} + ^{90}\text{Kr} + 3\text{n}$
 - $^{235}\text{U} + \text{n} \rightarrow ^{128}\text{Sb} + ^{101}\text{Nb} + 6\text{n}$
 - $^{235}\text{U} + \text{n} \rightarrow ^{116}\text{Pd} + ^{116}\text{Pd} + 4\text{n}$

- Which of the following would correspond to $\Delta N/\Delta t$ for a radioactive material?
 - The number of seconds you need to wait until the entire sample has decayed.
 - The thickness of the material you would need to stop the radiation.
 - The half-life of the material.
 - The rate at which radioactive decay events are occurring.
 - The original number of radioactive nuclei.

Useful expressions

$$\frac{\Delta N}{\Delta t} = R = -\lambda N$$

$$N = N_0 e^{-\lambda t}$$

$$\tau_{1/2} = \frac{\ln 2}{\lambda}$$

Exercises

4. Match the following types of radioactive decay with the correct statements about them. Note that more than one statement may apply to each type of decay.

Alpha Decay

Beta Decay

Gamma Decay

A proton turns into a neutron, releasing a positron (antielectron) and a neutrino.

The number of nucleons in the nucleus (A) decreases by 4.

The atomic number of the nucleus (Z) is increased or decreased by 1.

The nucleus drops from an excited energy level to a lower energy level, releasing a high energy photon.

The results of this decay process will not be affected if they pass through a B-field.

A neutron turns into a proton, releasing an electron and a neutrino.

5. We have a sample of carbon that contains both carbon-12 and carbon-14. We'd like to know how long it will take until this sample contains 75% of the carbon-14 it does right now. The half-life for C-14 is 5730 years.

A. In short, we want to know when N/N_0 is going to be equal to 0.75. Before we can find a time, we need to calculate one unknown from the things we do know. Circle the one you think we need.

e N_0 λ $\tau_{1/2}$

B. What is λ for C-14?

C. What units are λ in? Given that, what units does t in the expression $e^{-\lambda t}$ need to be in?

D. Now we need an expression for N/N_0 . Write one below.

E. Just for fun, we might start by guessing that the C-14 will reduce by one-quarter (25%) in one-half of one half-life. Is this true?

F. Since our guess in E wasn't correct, solve the expression from part D for t . Note that $\ln(e^x) = x$, where \ln is the natural logarithm.

G. How long from the present will the amount of C-14 have reduced to 75% of the current amount in our sample?

H. If we found a piece of wood buried in an archeological dig site and determined that 25% of the C-14 that was originally present when the wood was cut now remains, how old is our find?

6. An excited $^{236}_{92}\text{U}$ nucleus undergoes fission into two fragments according to the following reaction:

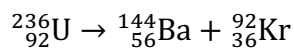

The isotope masses are given in the table below. (Recall $1 \text{ u} = 931.494 \text{ MeV}/c^2$)

$^{92}_{36}\text{Kr}$	91.926270 u
$^{144}_{56}\text{Ba}$	143.922845 u
$^{236}_{92}\text{U}$	236.045563 u

A. What is the combined mass of the reaction products?

B. What is the mass defect Δm in this reaction?

C. How much energy is released in a single fission reaction of this type?

7. Suppose a 5 kg cache of strontium-90 is accidentally released in a medical facility. The atomic weight of strontium-90 is 89.9 u and the half-life is 28.8 years. We'd like to know how dangerous this situation is.
- A. How many nuclei of strontium-90 were let loose? (Note that 1 atomic mass unit, u, is equal to 1.66×10^{-27} kg.)

 - B. What is λ for strontium-90?

 - C. If you walked into the building with a radioactivity detector, how many decays per second would it register?

 - D. The *rem* is a unit of radiation dosage. Roughly speaking, exposure to 10^7 counts from strontium-90 amounts to 1 rem. How many rem would you be exposed to if you stayed in the building for a full minute?

 - E. Considering that exposure to more than 500 rem over a short period results in 50% mortality, would you recommend that anyone enter?

 - F. If an activity (another word for $\Delta N/\Delta t$) of 10 counts/minute is an acceptable exposure for strontium-90, how long will it take before the building becomes safe?