

Introduction and Electric Charge – Group Sheet
Physics 104 – General Physics

Welcome to Physics 104!

Today your TA will give you some basic information about how discussion section will work this semester, followed by an icebreaker exercise for the entire class.

Once you are assigned to a breakout group, record the names of all your group members at the top of this sheet. Once you're in your small group, determine one thing that all of you have in common (NOT including: "you're all students," "you're all taking physics," "you're all in Madison/Wisconsin/on Earth," or "you're all human beings").

1) The picture to the right shows the excess charge distribution on a neutral electroscope when a rod is brought near it. What is the sign of the excess charge on the rod?

- a) Positive
- b) Negative
- c) It has no charge
- d) It depends on the atmospheric conditions
- e) Cannot tell from the given information

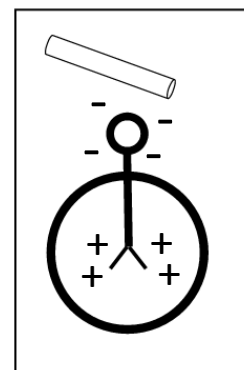

2) You have a glass rod that has been rubbed with silk, and a small neutrally-charged aluminum foil ball attached to a thread. Describe what happens when you slowly approach the ball with the rod and then make contact between the ball and the rod.

- a) The ball swings toward the rod, then falls back close to its original position.
- b) The ball swings away from the rod, then stays attached to it.
- c) The ball doesn't move until touched by the rod, and then swings away from it.
- d) The ball swings toward the rod, then swings away from it.
- e) The ball stays in its original position throughout.

(Remember to turn this page in to your TA)

Reflect on the experience you've had so far with today's topic. What sorts of notes might you want to write on a note sheet for the exam (which you can test out by using for the rest of the worksheet and on this week's homework and quiz too)? Keep these notes to help assemble your full note sheet in a few weeks. We'll also ask you to bring your nearly complete note sheet to the discussion just before each exam to share with your group mates.

3) Glass tends to acquire a positive charge when rubbed with silk. Based on this information, sketch a picture of the final excess charge distributions on the glass rod and the aluminum foil ball from question #2.

4) You may have experienced or observed that after rubbing a balloon on your hair, individual hair strands tend to be attracted to the balloon.

A) Explain the attraction between the strands of hair and the balloon. Draw a picture if needed.



Credit: Exploratorium Teacher Institute

B) The Triboelectric Series describes how materials tend to exchange charge upon being rubbed together. Use the table to decide what kind of charge the balloon has gained and what kind of charge the hair has gained.

Balloon: + or -

Hair: + or -

C) Is your response to part B consistent with what you know about how like and opposite charges respond to one another?

D) After being rubbed on a person's hair, a balloon is observed to attract small bits of paper. Explain how this can be possible.

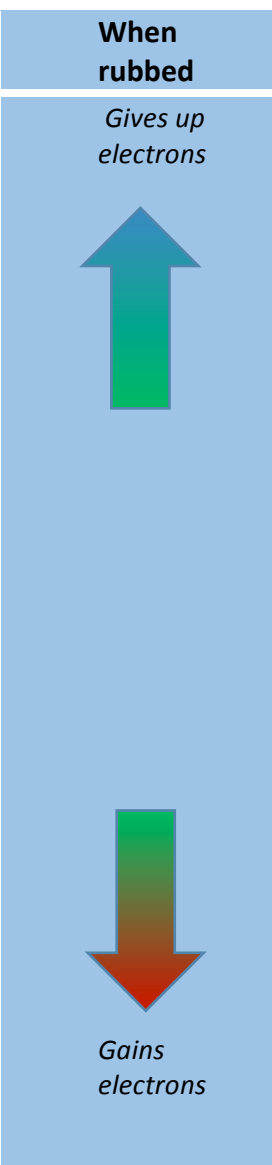
Material	When rubbed
Hair (most positive)	 <p><i>Gives up electrons</i></p>
Rabbit fur	
Acrylic (clear plastic)	
Hands, skin	
Glass	
Nylon	
Lead	
Silk	
Aluminum	
Cotton (neutral)	
Steel	
Wood	
Ebonite (black plastic)	
Nickel, copper	
Brass, silver	
Rayon	
Polyester	
Styrofoam	
Polyethylene	
PVC	
Teflon (most negative)	<i>Gains electrons</i>

5) Suppose that equal amounts of excess negative charge are deposited on the left side of the two spheres (where the arrow is pointing). One is made of an insulating material and the other made of a conducting material. Sketch how you would expect the excess charge distributions to differ between the two. Explain.

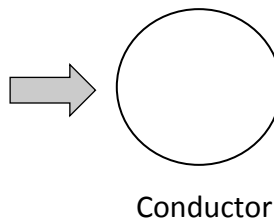
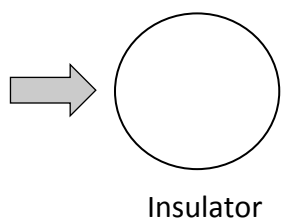

6) In the situations below, predict what excess charge will result on the conducting sphere.

A) Metal sphere A is initially neutral. A positively charged rod is brought near, but not touching. Is sphere A now *positive, negative, or neutral*? Explain.

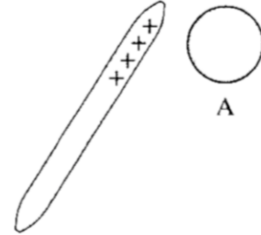

B) Metal spheres A and B are initially neutral and are touching. A positively charged rod is brought near A, but not touching. Is sphere A now *positive, negative, or neutral*? Explain.

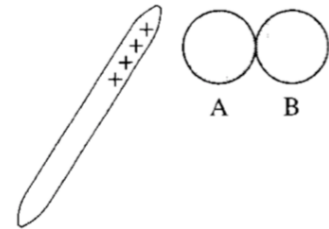

C) Metal sphere A is initially neutral. It is connected by a metal wire to the ground. A positively charged rod is brought near, but not touching. Is sphere A now *positive, negative, or neutral*?

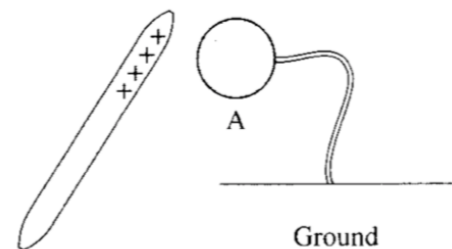

7) Consider the following two situations: (1) We have two charges, one positive and one negative, in an empty space (that is, nothing around them at all), as shown below. (2) We have the same two charges at the same distance from one another in a fluid composed of a large number of positive and negative ions.

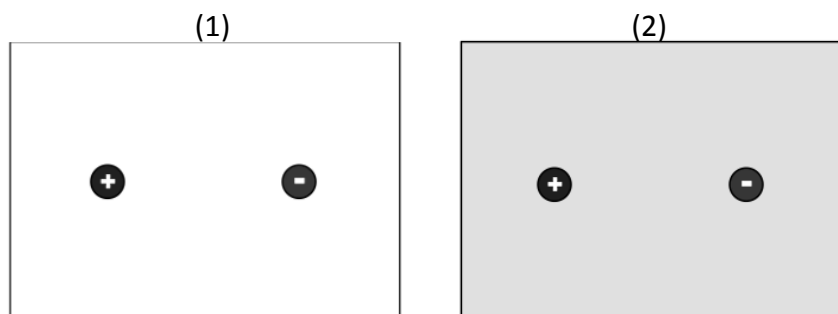

A) In which situation will the attractive force between these two charges be greater? Explain your reasoning.

B) Use your conclusion to explain why the forces between charges in biological situations are typically not as strong as the forces in more idealized situations.

1) Two charged objects are a certain distance apart. If you double the charge on one of them and double the distance that separates them, what happens to the Coulomb force between them?

- a) It is unchanged.
- b) It is a quarter of what it was.
- c) It is twice what it was.
- d) It is four times what it was.
- e) It is half of what it was.

2) Four charges are arranged as shown at right. If the total Coulomb force on Q_A is zero, what is the sign of the charge on Q_D ?

$Q_C = -q$

$Q_A = +q$

$Q_B = -q$

Q_D

- a) Positive
- b) Negative
- c) Could be positive or negative

3) Which of the following best explains how a gecko can climb smooth surfaces such as glass?

- a) Gecko foot pads have a net positive charge, so they stick to walls in the same way a rubbed balloon will.
- b) As they move, geckos remove electrons from neutral surfaces through the triboelectric effect.
- c) Geckos can generate electric fields that pull them toward surfaces or even allow them to hang from ceilings.
- d) Molecular dipoles within gecko foot pads attract other molecular dipoles within surfaces.

Useful Expressions:

$$|\vec{F}_e| = k \frac{|q_1||q_2|}{r^2}$$

Reflect on the experience you've had so far with today's topic. What sorts of notes might you want to write on a note sheet for the exam (which you can test out by using for the rest of the worksheet and on this week's homework and quiz too)?

4) On the figure below, mark the position or positions where a proton would experience no net force.



A) Would the force on an electron at this position (or positions) be to the left, to the right, or zero?

B) On the figure below, mark the position or positions where an electron would experience no net force.



5) So far in class we have examined the force exerted by a dipole. Now what about the force exerted on a dipole?

Let's model a dipole as a negative (q_A) and a positive (q_B) charge linked by a solid bar of length $2L$ that won't stretch or compress. There is a nearby negative charge (q_C) that is a distance d above the midpoint of the bar. Assume all the charges in the picture have the same magnitude of charge, q .

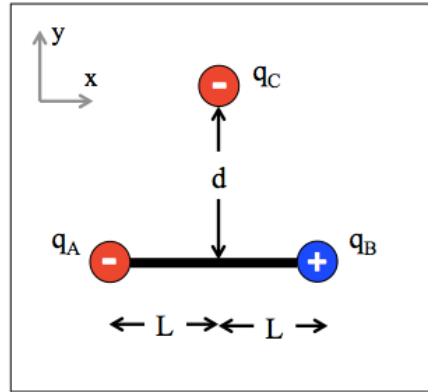

A) Start by making a prediction. What do you think will happen to the dipole because of the force exerted by the negative charge? Will it move? If so, how?

B) Using the numbers to the right, determine the magnitude F_{CA} of the Coulomb force that q_C exerts on q_A .

$q_A = 10 \text{ nC}$
 $q_B = 10 \text{ nC}$
 $q_C = 10 \text{ nC}$
 $L = 300 \mu\text{m}$
 $d = 400 \mu\text{m}$

C) Sketch the vector \vec{F}_{CA} . Use your drawing to determine its x- and y-components.

$F_{CA,x} =$

$F_{CA,y} =$

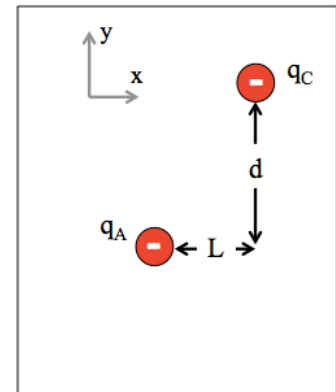

D) Determine the magnitude F_{CB} of the Coulomb force that q_C exerts on q_B .

E) Sketch the vector \vec{F}_{CB} . Use your drawing to determine its x- and y-components.

$$F_{CB,x} = \boxed{}$$

$$F_{CB,y} = \boxed{}$$

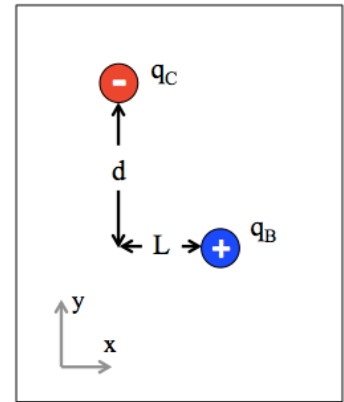

F) What is the total force on the dipole?

$$F_{Total,x} = \boxed{}$$

$$F_{Total,y} = \boxed{}$$

$$F_{Total} = \boxed{}$$

G) Will the dipole experience any linear motion (up, down, sideways)?

H) Let's go a little further. Will the dipole experience any *other* kind of motion? Can you describe what sort of motion this will be? (Hint: Draw an extended free body diagram of the dipole.)

I) What would the motion of the dipole be if you flipped the negative charge over, so it was underneath the dipole?

6) Consider two carbon monoxide molecules that are near each other as shown. Assuming that all the charges are $2e$ (where e is the fundamental charge), L is 2 nm, and d is 50 nm, what force do the dipoles exert on each other? Indicate both magnitude and direction.

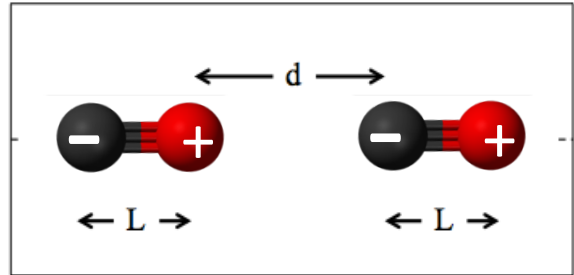

7) Here's a puzzle: You're on the international space station, which means you and everything around you is weightless. For fun, you take a sphere with a charge of Q . You connect it with a string made from an insulating material to another sphere with charge $2Q$. You then place these charges so that the midpoint of the string is exactly between two metal bulkheads that have no net charge.

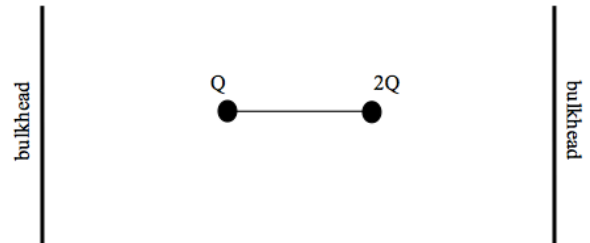

When you let the two charged spheres go, how will they move, if at all? Why or why not?

Vectors Primer

Like all forces, the Coulomb force is represented by a vector. To deal with it, then, and with other vector quantities we'll be encountering in this course, you'll need to draw on your vector knowledge.

There are two methods of adding vectors:

- The tip-to-tail method (or the graphical method)
- The component method

To use the first method, imagine each vector as an instruction. Vector A, which has a magnitude of 10 units and is directed 45° counterclockwise from the positive-x axis is something like "take 10 steps in a northeast direction."

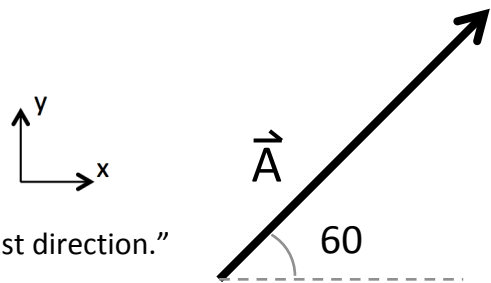

Vector B has a magnitude of 5 units and is directed along the negative-x axis and is something like "take 5 steps to the west." Adding a second vector A to B is just stringing the two instructions they give together sequentially. Note that whether you start with A and then B, you get to the same spot you would have reached if you'd started with B and then A.

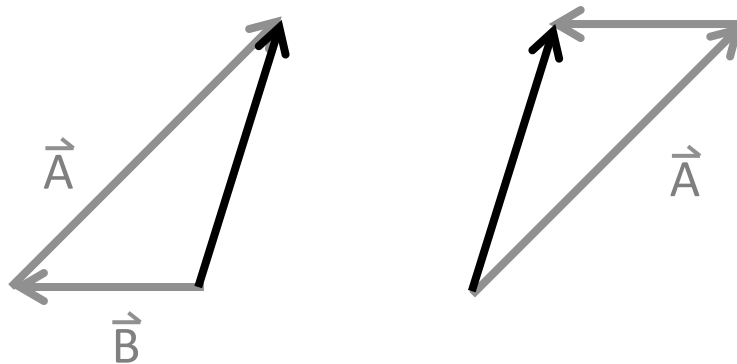
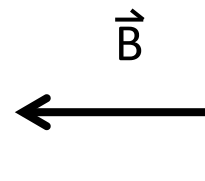

The other way to do vector math involves decomposing vectors into components. In this case, you use trig functions to find the x and y pieces that make up the vector and then add (or subtract) all the x pieces and all the y pieces separately.

If we go back to vector A, then the x component of A would be the length of A times $\cos(60^\circ)$ and the y component of A would be the length of A times $\sin(60^\circ)$. For the purposes of this course, we can always assume the x axis runs right-left (and is positive to the right) and the y axis runs up down (and is positive up).

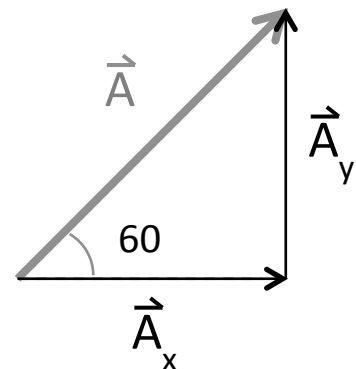

Electric Fields and Potential Energy – Group Sheet
Physics 104 – General Physics

Your group member names:

1) You place a $5 \mu\text{C}$ test charge in an electric field and determine it feels a force of $1.25 \times 10^{-3} \text{ N}$. What would the electric field strength be if you use a $-10 \mu\text{C}$ test charge?

- a) 100 N/C
- b) 1000 N/C
- c) 5000 N/C
- d) 250 N/C
- e) 500 N/C

2) Which object has the greatest amount of excess positive charge?

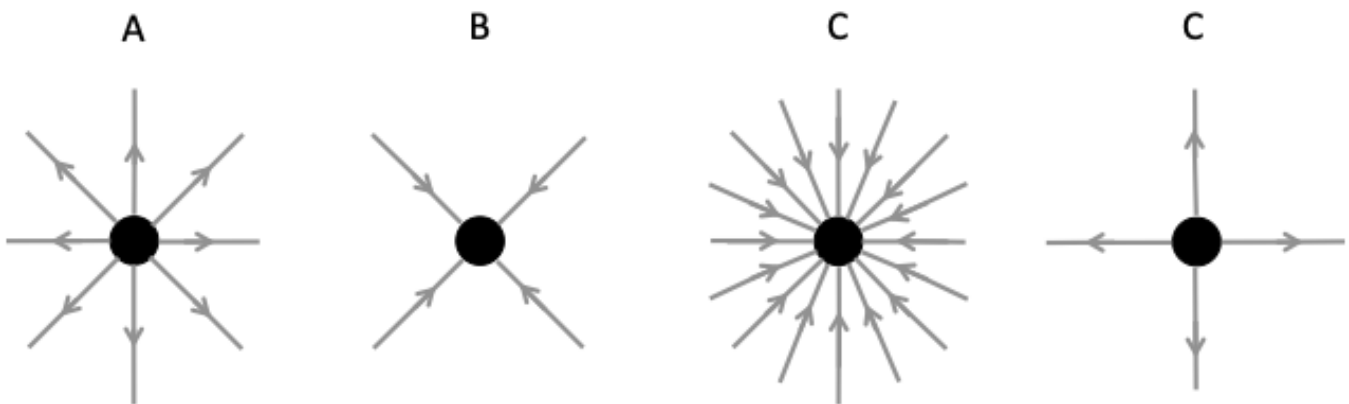

3) A charged particle moves in a constant E-field as shown. Is electrical potential energy lost, gained, or does it stay the same?

- a) Gained
- b) Lost
- c) Stays the same
- d) Depends on the strength of the E-field, E
- e) Depends on the magnitude of the charge, q

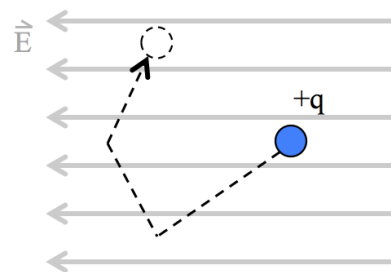

Useful Expressions:

$$|\vec{F}| = |q||\vec{E}| \quad |\vec{E}| = k \frac{|q|}{r^2} \quad U_{elec} = k \frac{q_1 q_2}{r}$$

Reflect on the experience you've had so far with today's topic. What sorts of notes might you want to write on a note sheet for the exam (which you can test out by using for the rest of the worksheet and on this week's homework and quiz too)?

4) Consider this pair of charges:

A) What's the direction of the E- field due to both charges for points on the dotted line in region I?

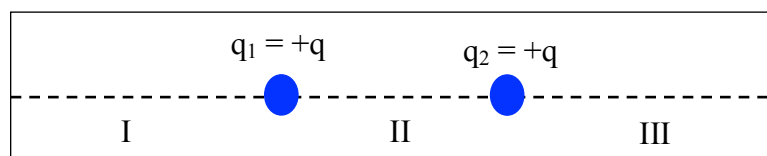

B) What's the direction of the E-field due to both charges for points on the dotted in region III?

C) Is there a place in region II on the dotted line where the electric field due to both charges is equal to zero? If so, mark it above with an X.

5) An object of charge of $-q$ is placed at a point a distance r from a sphere of charge $+Q$ and a distance $2r$ away from a sphere of charge $+2Q$. All three charged objects are fixed in place.

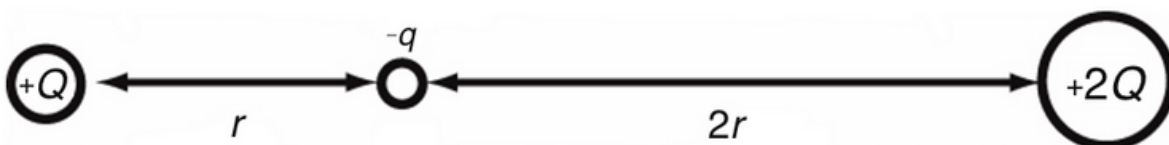

A) What is the magnitude and direction of the net electric field due to **both** the $+Q$ and $+2Q$ charges at the location occupied by the $-q$ charge?

B) What is the magnitude and direction of the net Coulomb force that **both** the $+Q$ and $+2Q$ charges exert on the $-q$ charge?

C) How would you describe the relationship between the net electric field you found in A and the net Coulomb force on the $-q$ charge you found in B?

D) If you replace the $-q$ charge with a $+3q$ charge, how will the net Coulomb force that **both** the $+Q$ and $+2Q$ charges exert change?

E) If you replace the $-q$ charge with a $+3q$ charge, how will the net electric field due to **both** the $+Q$ and $+2Q$ charges at the location occupied by the $+3q$ charge change?

6) Consider four charges arranged as shown to the right. We want to know what the charge on q_2 is so that the E-field at the point occupied by q_4 is zero.

A) What is the magnitude of the E-field due to q_1 at the location of q_4 ? (Don't worry if you have to leave some variables as unknowns.)

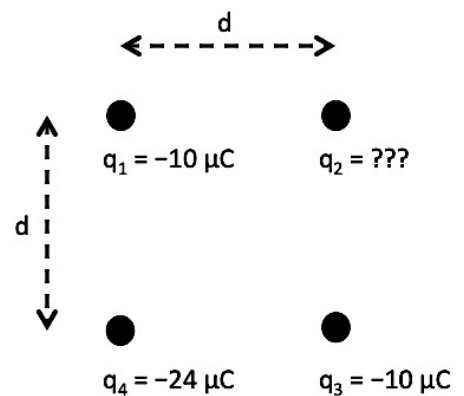

B) Draw the vector representing the E-field due to q_1 at the location of q_4 on the diagram.

C) What is the magnitude of the E-field due to q_3 at the location of q_4 ?

D) Draw the vector representing the E-field due to q_3 at the location of q_4 on the diagram on the previous page.

E) What must the E-field due to q_2 at the location of q_4 look like to make the net field at this location be zero?

F) Is the sign of charge q_2 *positive* or *negative*? How can you tell?

G) Find the vector addition of the E-fields due to q_1 and q_3 at the location of q_4 . Then use your result to find q_2 .

H) Did the charge on q_4 make a difference to your final answer? Why or why not?

l) Now that you know all the charges in the square, sketch what you think the electric field lines of this set of charges should look like.

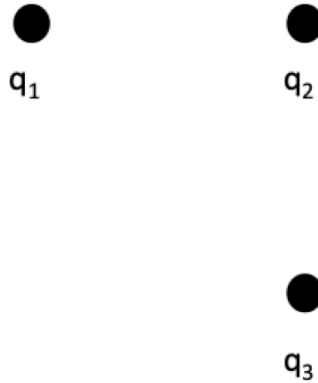

7) The strength of the average electric field inside a cell membrane is 5×10^6 N/C. The outside of the cell has a net positive charge. The inside of the cell has a net negative charge. The width of the average cell membrane is 10 nm.

A) Suppose an ion gate in the cell membrane expels a sodium ion (which has a net charge of $+e$, where e is the fundamental charge of 1.6×10^{-19} C). Is the work that the gate does *positive* or *negative*?

B) What is the magnitude of the work that the cell membrane does to eject the sodium ion? (Assume the E-field inside the cell is a constant one.)

8) Two alpha particles are fired directly toward each other from a great distance, each with a starting speed of 2.5×10^6 m/s. (A single alpha particle has a mass of 6.6×10^{-27} kg and a charge of $+2e=3.2 \times 10^{-19}$ C.) How close do the two alpha particles get to one another before they stop?

Your group member names:

1) A charged particle moves in a constant E-field as shown. Is electrical potential energy lost, gained, or does it stay the same?

- a) Gained
- b) Lost
- c) Stays the same
- d) Depends on the strength of the E-field, E
- e) Depends on the magnitude of the charge, q

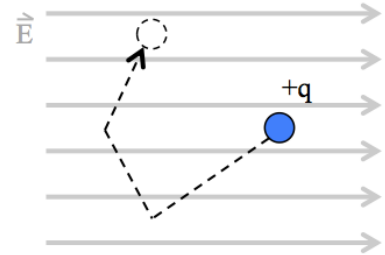

2) In the above example does the particle move through a voltage difference?

- a) Yes, it moves to a higher voltage
- b) Yes, it moves to a lower voltage
- c) No, it does not move through a voltage difference
- d) Depends on the strength of the E-field, E
- e) Depends on the magnitude of the charge, q

3) In the above diagram, draw the equipotential surfaces (in this case lines) for this particular E-field. Is this consistent with your answer to 2)?

Electric Potential
Physics 104 – General Physics

Useful Expressions:

$$E = k \frac{|q|}{r^2}$$

$$F = |q|E$$

$$U = k \frac{q_1 q_2}{r}$$

$$V = \frac{U_{elec}}{q_0} = k \frac{q}{r}$$

$$\Delta V = -Ed \cos \theta$$

Reflect on the experience you've had so far with today's topic. What sorts of notes might you want to write on a note sheet for the exam (which you can test out by using for the rest of the worksheet and on this week's homework and quiz too)?

4) The box pictured at right contains a uniform electric field (that is, the field is the same everywhere). The field lines are drawn. Points A through D form a square that's 8 cm on each side. Point E is in the center of the square.

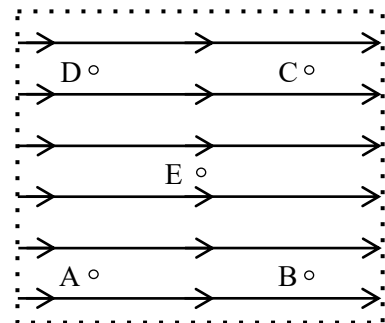

A) If we place an object with a charge of $+10 \mu\text{C}$ at point A, in which direction will it move?

B) If the $+10 \mu\text{C}$ object starts at rest at point A and gains $2.4 \times 10^{-4} \text{ J}$ of kinetic energy by the time it reaches B, what is the electric potential difference between A and B?

C) How much work does the electric field do on the object as it travels from A to B?

D) What is the potential difference between points A and D? (Hint: How much work does the electric field do on a charged object as it moves from A to D?)

E) Given your answer to B, what is the voltage difference between points A and E?

F) What is the strength of the electric field in this area?

G) How much work do you do to move a $-10 \mu\text{C}$ charge from D to B? Is this positive or negative work?

5) Gel electrophoresis is an analysis technique used to identify DNA. Although we can't model the full process with the tools we've developed so far, largely due to the complexity of how the molecular fragments "drift" down through the gel, we can apply some of what we know about electrostatics to understand this technique.

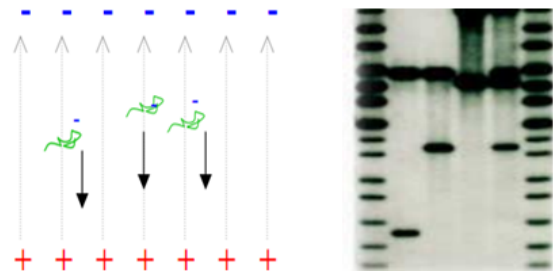

A) Let's say you're working with a gel that's 10 cm long, and the voltage you've applied is 100 V. Assuming the E-field in the gel is uniform, what is its magnitude? (Ignore any effects that the gel itself might have on the field.)

Electric Potential

Physics 104 – General Physics

B) You put the DNA fragments you're working with at the top of the gel and turn on the voltage. After an hour, the fragments that are 3000 base pairs long have made it 8 cm along the gel. How much work did the electric field have to do to get them there? (Each base pair has a negative charge of $-3e$.)

C) What potential difference did the 3000 base pair fragments pass through in their 8 cm trip?

D) Why do people use an electric field in this process? Why not just tilt the gel and let gravity pull the DNA fragments down? (Use at least one calculation to justify your answer. It might help you to know that a base pair has a mass of about 1.1×10^{-24} kg.)

6) Two particles each have the same mass, m . However, the first particle has a charge of $4q$ while the second particle has a charge of only q .

A) The first particle is accelerated from rest through a potential difference of ΔV . What is its final speed, v_1 ? Write an equation for v_1 in terms of m , q , and ΔV .

B) The second particle is also accelerated from rest through a potential difference of ΔV . What is its final speed, v_2 ? Again, write an equation for v_2 in terms of m , q , and ΔV .

Electric Potential
Physics 104 – General Physics

C) How much larger or smaller is v_2 than v_1 ?

D) Did the E-field do more work on the first particle or the second particle?

7) The next few questions involve the charges shown at right.

A) What is the magnitude and direction of the electric field at point X?

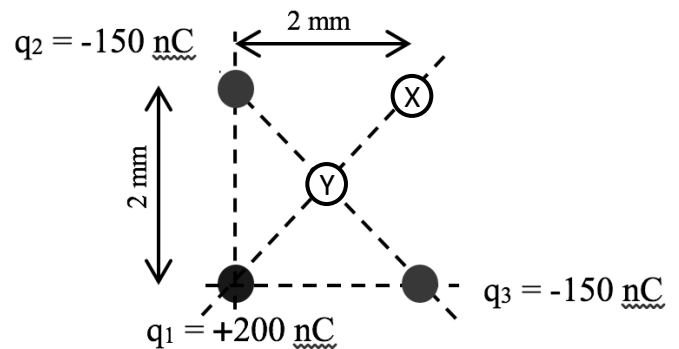

B) What is the electric potential at X, assuming $V=0$ at infinity?

C) Say you brought a fourth charge with $q_4 = +100$ nC in from very far away (essentially infinitely far). How much potential energy would it gain or lose?

D) How much work would you need to do to bring q_4 from infinitely far away to X?

Electric Potential
Physics 104 – General Physics

E) How much work would you do if you moved q_4 from X to the location marked Y?

F) With q_4 at position Y, what are the E-field (magnitude and direction) and the electric potential (assuming PE = 0 at infinity) at X?

Your group member names:

1) Imagine a capacitor with a capacitance of $50 \mu\text{F}$. In one case, this capacitor is connected to a 10 V battery. In the other case, the capacitor is fully charged and then disconnected from a battery. Suppose we now increase the separation between the plates of each capacitor by an equal amount. Answer the following for each case.

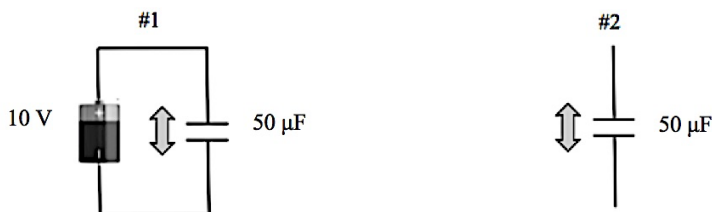

A) Circle the parameter ($\Delta V =$ the voltage difference between the plates and $q =$ the charge on the plates) that remains constant as we move the plates apart:

ΔV	q		ΔV	q
------------	-----	--	------------	-----

B) What happens to the E-field between the plates? (Hint: Remember $\Delta V = Ed$ for a uniform E-field and $E = \frac{q}{A\epsilon_0}$ in a capacitor.)

Increases	Decreases	Same		Increases	Decreases	Same
-----------	-----------	------	--	-----------	-----------	------

C) What happens to the capacitance of each capacitor?

Increases	Decreases	Same		Increases	Decreases	Same
-----------	-----------	------	--	-----------	-----------	------

D) What happens to the parameter (ΔV or q) that doesn't remain constant?

Increases	Decreases	Same		Increases	Decreases	Same
-----------	-----------	------	--	-----------	-----------	------

E) What happens to the energy stored in each capacitor?

Increases	Decreases	Same		Increases	Decreases	Same
-----------	-----------	------	--	-----------	-----------	------

F) What happens to the capacitance if a dielectric slab is inserted between the plates?

Increases	Decreases	Same		Increases	Decreases	Same
-----------	-----------	------	--	-----------	-----------	------

Useful Expressions:

$$C = \frac{q}{\Delta V}$$

$$C = \frac{\epsilon_0 A}{d}$$

$$C = \kappa C_0$$

$$E = \frac{\sigma}{\epsilon_0}$$

$$\sigma = \frac{q}{A}$$

$$U = \frac{1}{2} q \Delta V = \frac{1}{2} C (\Delta V)^2 = \frac{1}{2} \frac{q^2}{C}$$

Reflect on the experience you've had so far with today's topic. What sorts of notes might you want to write on a note sheet for the exam (which you can test out by using for the rest of the worksheet and on this week's homework and quiz too)?

2) As you've already seen in your prelecture, the membrane of a cell acts like a capacitor.

A) Explain in your own words why we're justified in calling the cell membrane a capacitor? Hint: What about the cell membrane resembles a capacitor?

B) The capacitance of cell membranes has been measured to be 10^{-2} F per square meter of surface area. For a spherical cell with a radius of $20 \mu\text{m}$ (a typical size for a mammalian cell), what is the total capacitance of the cell's membrane?

C) At its resting potential (that is, a 70 mV potential difference across the membrane), how much charge is accumulated on either side of the membrane?

D) How much electrical potential energy is stored across the cell's membrane?

E) If the total number of cells in a human being is, on average, 37×10^{12} , how much electrical potential energy is stored in all the cells in your body?

3) Below is a cell membrane made of lipid molecules which together act like a dielectric in between the charges (ions) gathered outside and inside the cell. Outside there are excess positive ions and inside are excess negative ions which attract each other across the membrane and so accumulate in equal numbers on either side. In response the lipid molecules become polarized as shown. The dielectric constant for the average cell membrane is 5.

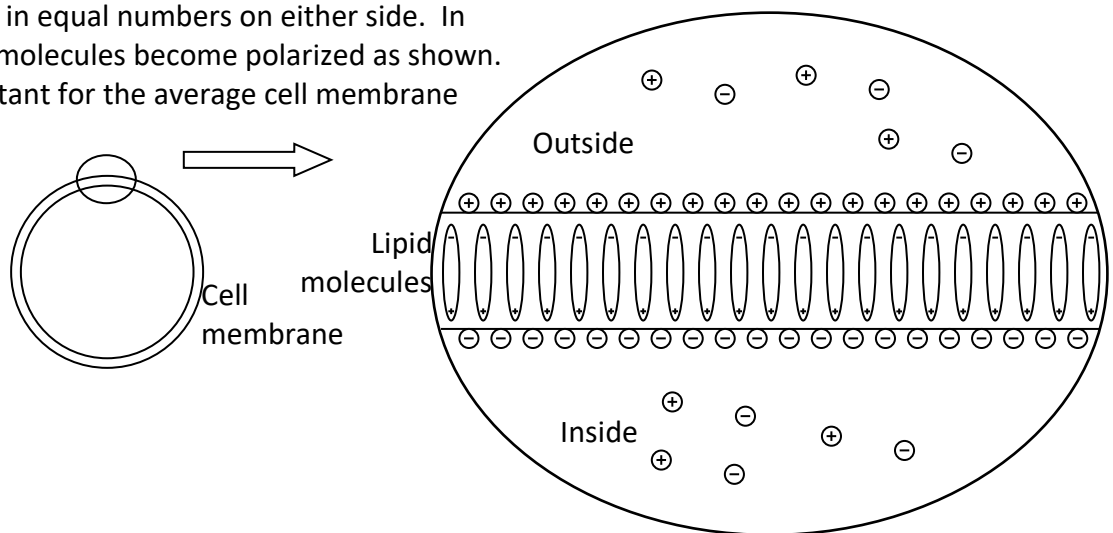

A) If the thickness of the membrane is 10 nm, what is the magnitude and direction of the net E field in the cell membrane when there is a 70 mV voltage difference across the membrane?

B) What is the magnitude and direction of the E field in the cell membrane due only to the accumulated charge?

C) What is the magnitude and direction of the E field in the cell membrane due only to the polarized lipid molecules?

4) Two parallel-plate capacitors, A and B, are connected to batteries of the same voltage (10 V) as shown below.

A) Assuming that the negative plate is at -5 V and the positive plate is at $+5$ V, draw the equipotential lines for -3 V, -1 V, $+1$ V, and $+3$ V between the two plates of each capacitor.

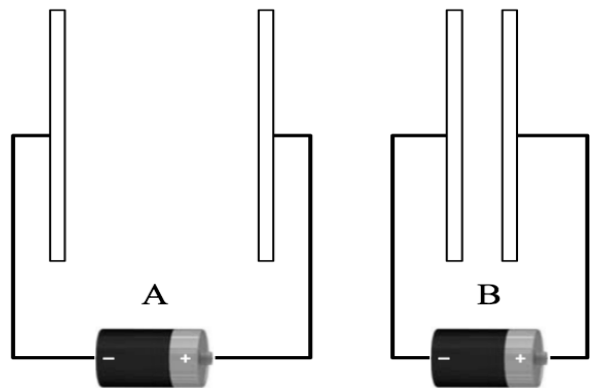

B) Use your drawing to explain why the E -field between the plates is larger for capacitor B than for capacitor A.

Capacitance
Physics 104 – General Physics

C) Remember that the strength of the E field is proportional to the charges on the two objects (that is, greater charge, more E field). Use this to explain which pair of plates contained more charge.

D) Using your answer to C, explain which capacitor has the largest capacitance and why.

E) Suppose the plates were initially in position A and you moved them to position B. Is the electrical potential energy stored by the plates increased or decreased?

F) Does charge flow as you do this?

5) Consider the arrangement of two capacitors, A and B, connected to a source of voltage below. Note that both pictures are completely equivalent.

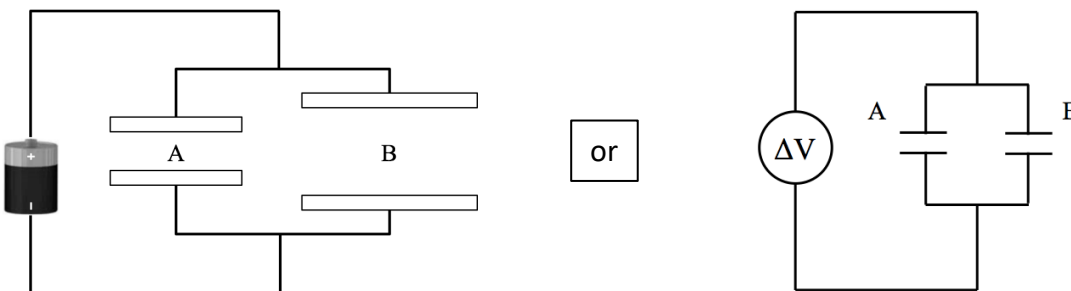

What could you be asked to find about this arrangement? Fill out as many of the lines as you can below. One has been finished for you as an example.

Capacitance
 Physics 104 – General Physics

Given these quantities...	...what could you be asked to find?
The capacitance of A, the capacitance of B, and the charge on A.	<ul style="list-style-type: none"> - The equivalent capacitance of A and B - ΔV - The charge on B
The capacitance of A, the distance between A's plates, and ΔV .	
The capacitance of B, the distance between A's plates, the charge on A, the charge on B.	
The energy stored in A, ΔV , and the charge on B.	
The distance between A's plates, the distance between B's plates, the area of A's plates, the area of B's plates, the magnitude of the E-field in B.	
The energy stored in A and the energy stored in B.	

Your group member names:

1) Suppose you had a section of hollow tube and over a 10 second interval, a total charge of +2 C flowed through it to the right, while a total charge of -1.5 C flowed through it to the left. What is Δq passing to the right through a circular cross-section of the tube?

- a) +0.5 C
- b) +2 C
- c) +2.5 C
- d) +3.5 C
- e) +4 C

2) In the previous question, what is i ?

- a) 5 A to the left
- b) 0.35 A to the right
- c) 0.5 A to the left
- d) 2.5 A to the right
- e) 3.5 A to the right

3) Is this statement true or false: R of a resistor changes according to the voltage across it and the current flowing through it.

TRUE

FALSE

4) A 2-A current is moving through a wire with 100Ω of resistance. How much electrical potential energy does the moving charge lose every second? (Hint: This is not asking about voltage, but you will need to find the voltage drop across the wire to find an answer.)

- a) 400 J
- b) 100 J
- c) 2 J
- d) 200 J
- e) 800 J

Useful Equations:

$$i = \frac{\Delta q}{\Delta t} \quad v_{drift} = \frac{i}{neA} \quad R = \frac{\rho L}{A} \quad \Delta V_{device} = iR$$

Reflect on the experience you've had so far with today's topic. What sorts of notes might you want to write on a note sheet for the exam (which you can test out by using for the rest of the worksheet and on this week's homework and quiz too)?

5) A 1-Amp current is flowing through two materials to the right (as shown below). One material is a section of metal wire. The other is a tube of conductive fluid containing equal numbers of equally charged positive and negative ions. Assume that in the fluid, positive and negative ions most just as easily.

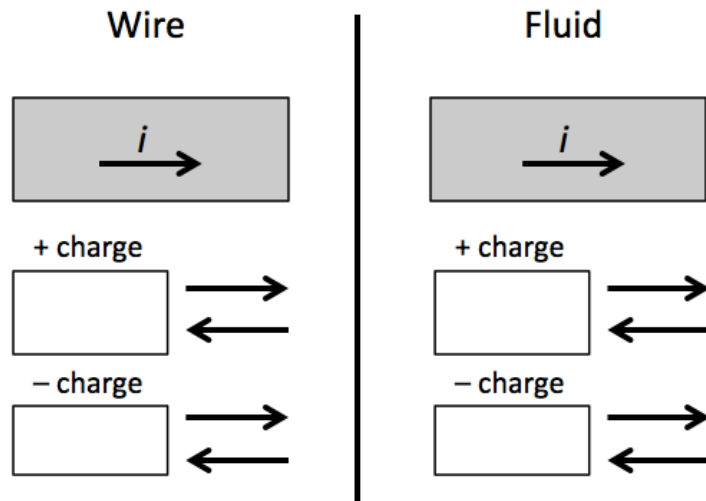

For each case (wire and fluid), indicate how much + and - charge moves through the material in a time interval of $\Delta t = 1 \mu s$ in the boxes provided and circle the correct arrow indicating the direction in which this charge moves

6) Electric eels bend around their prey to stun it, as shown in image #1. In order to stun larger prey, they bend even more to reduce the gap between their two ends, as shown at right.

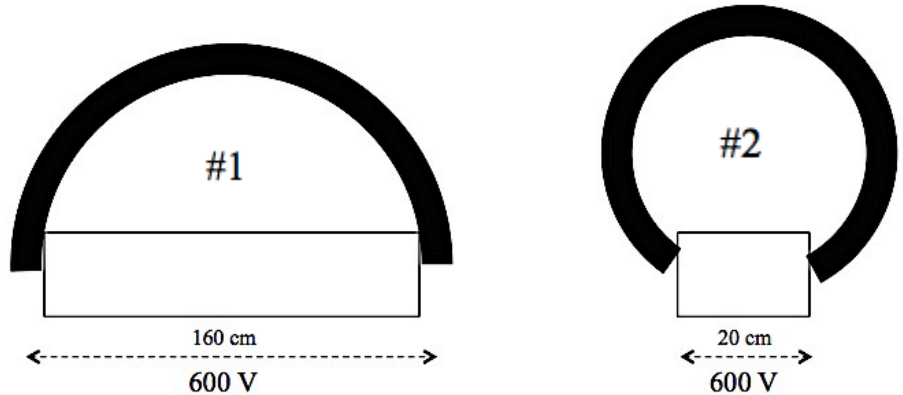

A) Assuming a typical voltage difference of 600 V between the eel's head and tail, draw the equipotential lines for 100 V, 200 V, 300 V, 400 V, and 500 V in the boxes provided. (Assume the eel's tail is at 0 V and the eel's head is at 600 V. Also assume the E-field in the area of the box is uniform.)

B) In which case does the electric field between the eel's head and tail have the greatest magnitude?

C) In which case will the drift speed of electrons between the eel's head and tail be largest? (Hint: Charges are moved by the E -field created by the voltage difference.)

D) In which case will the current through the eel's prey be largest?

E) Sea water is a good conductor. Air is a poor conductor. Use this to explain why there are no electric snakes.

7) Two circular wires, A and B, are connected to the source of a voltage difference, ΔV , as shown. Wire B is 3 times as long as wire A and wire A has 4 times the diameter of wire B.

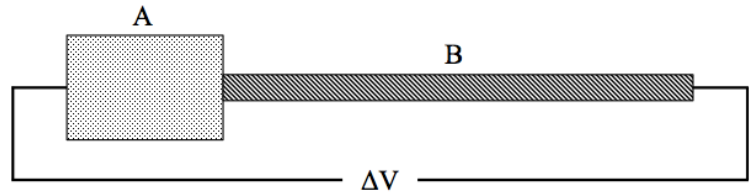

A) Suppose both wires are made out of the same material with identical numbers of moving charges per unit volume, n , and resistivity, ρ . Will there be a difference in the current passing through each wire? If so, which is greater?

B) Will there be a difference in the drift speed of charges in each wire? If so, which is greater?

C) As charges move through the wires, they lose potential energy, which we relate to a drop in voltage. Through which wire do the charges pass through the largest voltage drop? (Hint: You'll need to determine which wire has the largest resistance.)

D) Now, imagine that the two wires are made of different substances with different resistivities. Suppose that the resistivity of wire A, ρ_A , is 60 times the resistivity of wire B, ρ_B . Will the current still be the same in the two wires?

E) Charges moving through which wire experience the largest voltage drop?

F) Determine whether the following statements are true or false:

Narrower wires always have more resistance. TRUE FALSE

Voltage drops more the higher the resistance. TRUE FALSE

Current is higher where resistance is greater TRUE FALSE

Resistance is futile. TRUE FALSE

8) A current is flowing through a cylindrical segment of conductive material with a shape as shown.

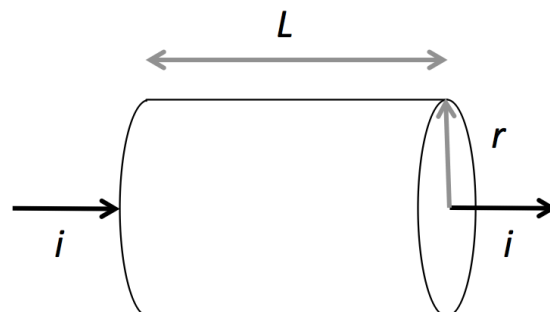

What could you be asked to find about this arrangement? Fill out as many of the lines as you can below. One has been finished for you as an example.

Given these quantities...	...what could you be asked to find?
The current through the material, the voltage drop across the segment, the length of the segment, and the resistivity of the material.	<ul style="list-style-type: none"> - The resistance of the segment - The cross sectional area of the segment - The radius of the segment
The current through the material, the number density of free electrons in the material, and the radius of the segment.	
The resistance of the segment, the voltage drop across the segment, and an elapsed time.	
The voltage drop across the segment, the resistivity of the material, the length of the segment, and the radius of the segment.	
The drift velocity of electrons in the segment, the number density of free electrons in the material, and the radius of the segment.	

Your group member names:

1) Decide whether the following statements are true or false:

A) When a single wire splits into 2 branches, the current in the single wire always splits into half.

TRUE FALSE

B) The sum of currents leaving a junction must be equal to the sum of currents entering the junction.

TRUE FALSE

C) The voltage difference between any two points in a circuit is always zero.

TRUE FALSE

2) For each circuit state which resistors, or network of resistors, are in series with each other and which resistors, or network of resistors, are in parallel with each other.

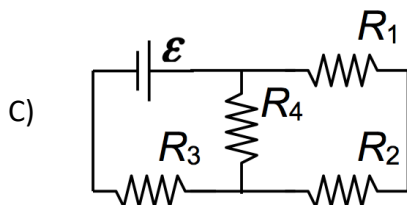
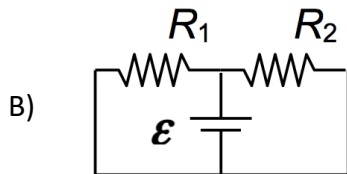
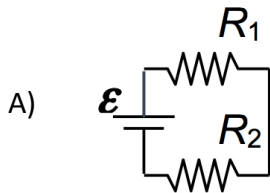

Useful Equations:

$$R_{\text{eq}} = R_1 + R_2 \quad (\text{series}) \qquad \frac{1}{R_{\text{eq}}} = \frac{1}{R_1} + \frac{1}{R_2} \quad (\text{parallel})$$

$$\Sigma i_{\text{in}} = \Sigma i_{\text{out}} \quad (\text{at a junction}) \qquad \Delta V = 0 \quad (\text{over a closed loop in a circuit})$$
$$\Delta V_{A \rightarrow B} = V_B - V_A \quad (\text{over a path from A to B})$$

Reflect on the experience you've had so far with today's topic. What sorts of notes might you want to write on a note sheet for the exam (which you can test out by using for the rest of the worksheet and on this week's homework and quiz too)?

3) Consider the circuit to the right.

A) Rate the voltage at the points shown. Be sure to justify your answer.

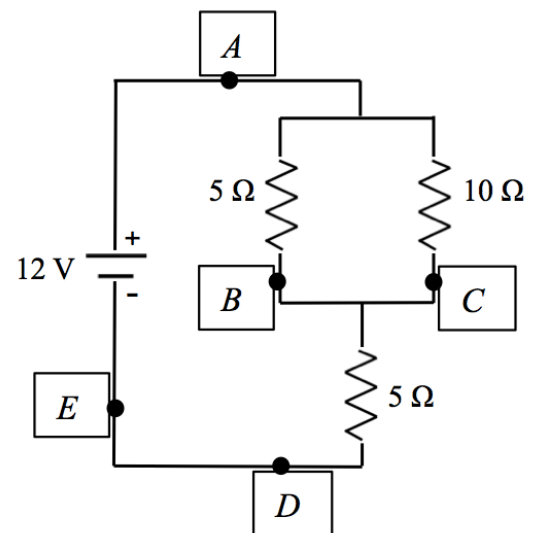

B) Rate the magnitude of the currents at the points shown. Again, justify your answer.

C) Is the current zero anywhere?

4) The circuit below contains three identical light bulbs.
The emf $\mathcal{E} = 120 \text{ V}$.

A) Rank the magnitude of the currents going through each bulb.

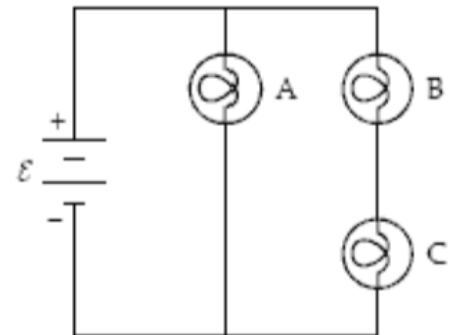

B) Rank the brightness of the bulbs.

C) After an unfortunate incident bulb B breaks. Which bulb(s) is/are still lit?

5) Consider the circuit to the right, where $R_1 = R_2 = 10 \Omega$, $\varepsilon_1 = 10\text{V}$, and $\varepsilon_2 = 5 \text{ V}$:

A) How many junctions can you identify?

B) How many loops can you identify?

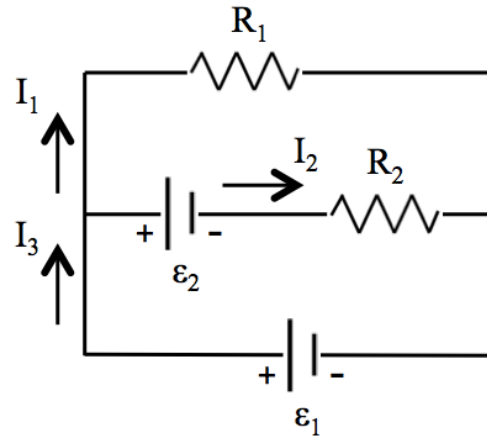

C) You want to find I_1 . How many loops from B do you need to do this?

D) What is I_1 ?

E) Which would be the worst choice of loop to use is you wanted to find I_1 ? Why?

6) In the following circuit, $R_1 = 500 \Omega$, $R_2 = 200 \Omega$, $R_3 = 1000 \Omega$, $\varepsilon_1 = 20 \text{ V}$, $\varepsilon_2 = 12 \text{ V}$.

A) How many currents are in this circuit?

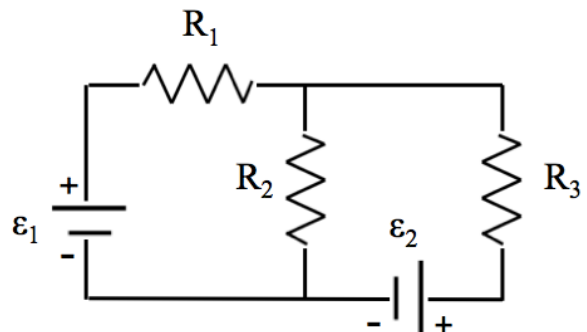

B) If the current through $R_1 = 27 \text{ mA}$, what are the other currents in this circuit?

7) Consider the following circuit:

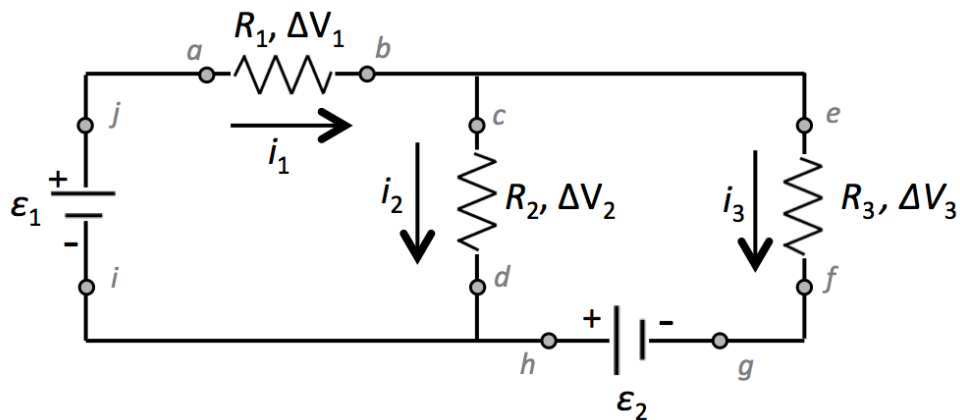

Below is a list of quantities related to the circuit. V_x refers to the voltage at point x (letters a through j). In the box to the right of each group, fill in the appropriate relationship between these quantities.

- | | |
|------------------------------------|----------------------|
| i_1, V_a, R_1, V_b | <input type="text"/> |
| $\epsilon_2, V_c, V_d, \Delta V_3$ | <input type="text"/> |
| i_1, i_2, i_3 | <input type="text"/> |
| ϵ_2, V_g, V_i | <input type="text"/> |
| $\epsilon_1, \Delta V_1, V_c, V_d$ | <input type="text"/> |
| $\epsilon_1, \epsilon_2, V_a, V_f$ | <input type="text"/> |

Your group member names:

1) Match the situation with the equation you'd use to find power.

- | | |
|-----------------|--|
| iV | <ul style="list-style-type: none"> • A 1200-Ω resistor is connected to a 15-V battery. What is the power dissipated by the 1200-Ω resistor? |
| $\frac{V^2}{R}$ | <ul style="list-style-type: none"> • A 200-Ω resistor is in series with two other resistors of unknown resistances and a 15-V battery. The equivalent resistance of all three is 600 Ω. What is the power dissipated by the 200-Ω resistor? |
| i^2R | <ul style="list-style-type: none"> • A 750-Ω resistor is connected in parallel with two other resistors to a 12-V battery. What is the power dissipated by the 750-Ω resistor? • A resistor has a current of 4 A running through it and a voltage gap of 6 V across it. What is the power dissipated by this resistor? • A 1000-Ω resistor is in a simple circuit (no junctions) with a battery. The current through the circuit is 0.5 A. What is the power dissipated by the 1000-Ω resistor? |

2) What is the voltage difference between the plates of an uncharged capacitor immediately after connecting it to a battery with voltage ϵ ?

- a) ϵ
- b) $\epsilon/2$
- c) $\epsilon/3$
- d) $\epsilon/4$
- e) zero

Bonus Question!
 What does "immediately after" mean?

- a) $t = 0$
- b) $t = RC$
- c) $t = \infty$

3) A fully charged capacitor with capacitance C is inserted into a circuit with a single resistor of resistance R and no battery. Sketch the graphs of the charge on the capacitor over time and the current in the circuit over time:

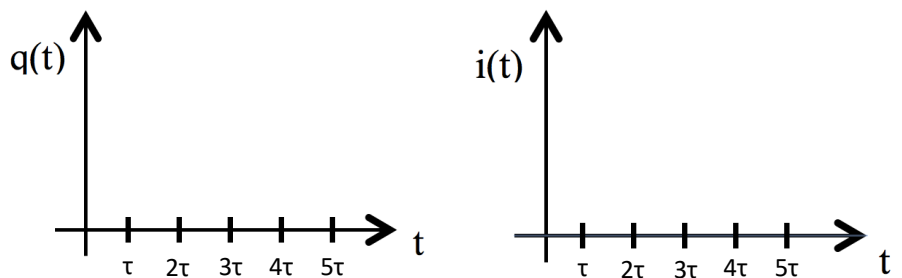

4) What could you do to make the current in the circuit described in 3 decrease faster?

- a) Increase C
- b) Decrease R
- c) Nothing – the time constant is a constant

Useful Equations:

$$P = i\Delta V = i^2R = \frac{\Delta V^2}{R}$$

Charging a capacitor

$$q_{\text{cap}}(t) = C\epsilon(1 - e^{-t/RC})$$

$$\Delta V_{\text{cap}}(t) = \epsilon(1 - e^{-t/RC})$$

$$i_{\text{cap}}(t) = (\epsilon/R)e^{-t/RC}$$

Discharging a capacitor

$$q_{\text{cap}}(t) = q_{\text{max}}e^{-t/RC}$$

$$\Delta V_{\text{cap}}(t) = (q_{\text{max}}/C)e^{-t/RC}$$

$$i_{\text{cap}}(t) = -(q_{\text{max}}/RC)e^{-t/RC}$$

Reflect on the experience you've had so far with today's topic. What sorts of notes might you want to write on a note sheet for the exam (which you can test out by using for the rest of the worksheet and on this week's homework and quiz too)?

5) A 200- Ω resistor is in series with two other resistors of unknown resistances and a 15-V battery. The equivalent resistance of all three is 600 Ω .

A) What is the power dissipated by the 200- Ω resistor?

B) Did you use the equation you chose in 1 above or a different one?

6) Recall that a cell membrane at its resting potential can be modeled as an RC circuit with capacitor, resistor, and battery in series.

The resistance of the ion gates depends on the size of the cell. For a cell 50 μm in radius, $R = 25,000,000 \Omega$. Similarly, the capacitance of a cell membrane depends on the size of the cell. For a cell with a radius of 50 μm , $C = 78.5 \text{ pF}$.

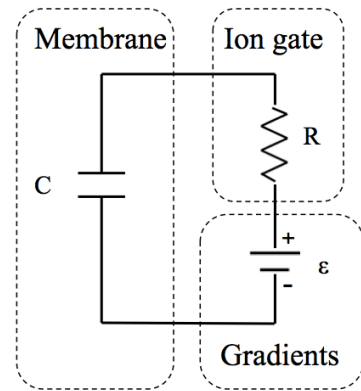

A) What is the time constant of the cell membrane as we've modeled it?

B) What sort of timescale would you expect changes in the voltage across the cell membrane to occur in? (Circle one)

nanoseconds microseconds milliseconds seconds

C) Which of the following most accurately represents what the time constant is?

- A measure of how much charge will accumulate in a system.
- A measure of how much time it takes to return a system to its initial state.
- A measure of how long it takes a system to change.
- A measure of how large the voltage change in a system will be.
- A measure of the overall complexity of a system.

D) The propagation speed of the action potential down an axon is inversely proportional to the time constant of the neuron's cell membrane. Use this fact offer one reason why the axons of some neurons are coated in a myelin sheath, making them thicker. (Hint: Think about the membrane as a capacitor and recall how capacitance varies with geometry.)

7) In the circuit shown, C is an uncharged capacitor with capacitance of 12 mF, R is a resistor with resistance 50Ω , and ϵ is a battery with voltage 5 V. Switch s is thrown and the capacitor begins charging.

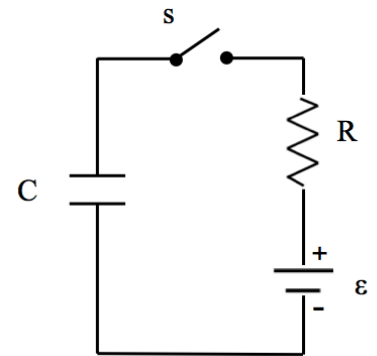

A) Indicate the direction of the current (while there is one) on the diagram above.

B) Indicate which plate of the capacitor is accumulating positive charge and which side is accumulating negative charge on the diagram.

C) At $t = 2\tau$, what is the charge on the capacitor, the current through the circuit, and the voltage difference across the capacitor?

$q(2\tau) =$ $\quad i(2\tau) =$

D) What is the voltage gap across the capacitor when $t = 2\tau$? (Hint: Remember the definition of capacitance.)

E) What is the charge on the capacitor, the current in the circuit, and the voltage difference across a long time has passed?

$q(\infty) =$ $\quad i(\infty) =$ $\quad \Delta V(\infty) =$

8) We now take the fully charged capacitor and place it in another circuit, this time without a battery. In this case, $R = 25 \Omega$.

A) Assuming we haven't changed the orientation of the capacitor at all, indicate which side has accumulated positive charge and which side has accumulated negative charge on the diagram to the right.

B) Draw the direction of the current in this circuit as the capacitor is discharging. Is this direction the same or different than the one you drew in 6A?

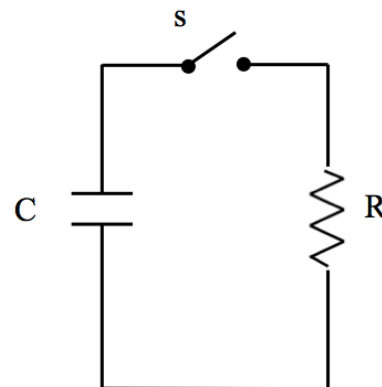

C) What is the current in the circuit at $t = 0$?

C) What is the charge on the capacitor, the current through the resistor, and the energy stored in the capacitor at $t = 1.2$ s?

$$q(1.2 \text{ s}) = \boxed{} \quad i(1.2 \text{ s}) = \boxed{} \quad U_{\text{cap}}(1.2 \text{ s}) = \boxed{}$$

D) When is the charge on the capacitor 50% of its maximum assuming the current started flowing at $t = 0$? [Hint: $\ln(e^x) = x$. Be sure to use the function “ln” on your calculator – this is called the natural log.]

9) Create a circuit with a switch that can be moved between two positions. In the first position, a bulb starts out dim and gets brighter and brighter. In the second position, the bulb starts out bright and gets dimmer and dimmer. In this way, you can create a flashing light.

You can use one or more of any of the following components: a bulb (of course), a capacitor, and a resistor. You may not need all of these. You can also add any number of branches.

The circuit has been started below.

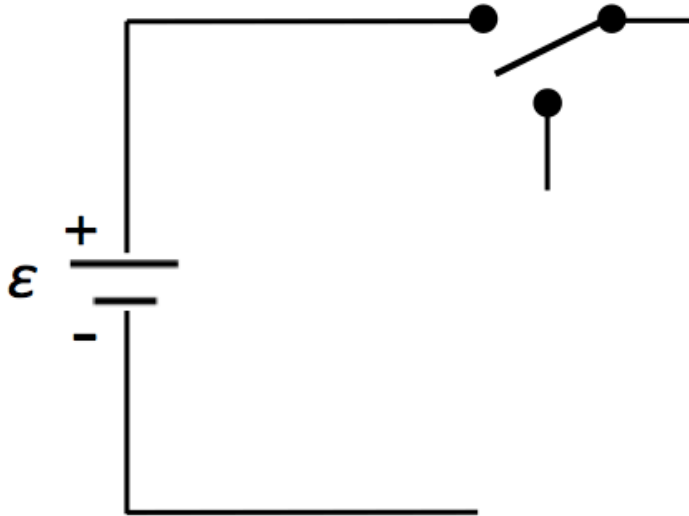

For an additional challenge, determine the resistances and capacitances of the elements in your system so that the bulb reaches 99% maximum brightness in 2 seconds and diminishes to 1% maximum brightness in 3 seconds. To make this possible, you may need to try drawing a new circuit.

Magnetism and Magnetic Forces – Group Sheet
 Physics 104 – General Physics

Your group member names:

1) Use the right hand rule to answer draw the direction of the magnetic force on each of the charged particles moving in a uniform B-field shown.

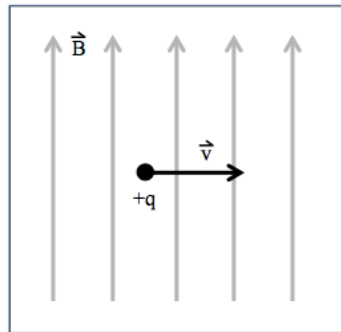

A) Positive charge, velocity right, B-Field up

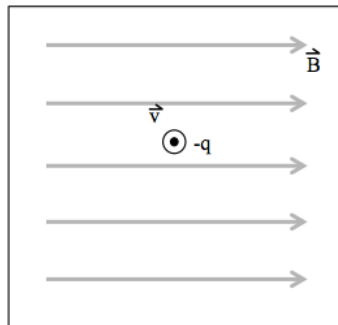

B) Negative charge, velocity out of the page, B-Field right

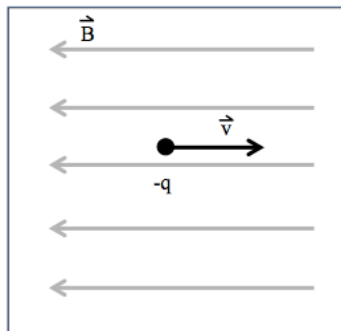

C) Negative charge, velocity right, B-Field left

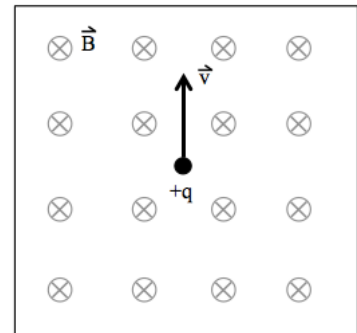

D) Positive charge, velocity up, B-Field into the page

2) Use the right hand rule to answer draw the direction of the magnetic force on each of the current-carrying wires in a uniform B-field shown.

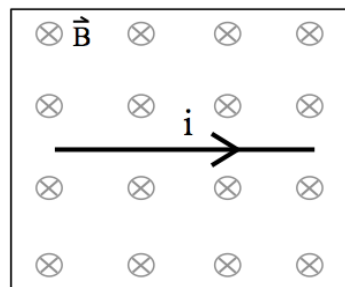

A) Current to the right, B-Field into the page

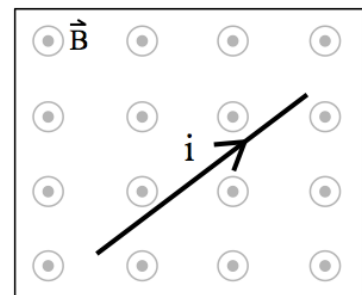

B) Current up and to the right, B-Field out of the page

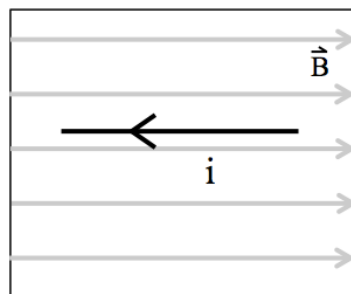

C) Current to the left, B-Field right

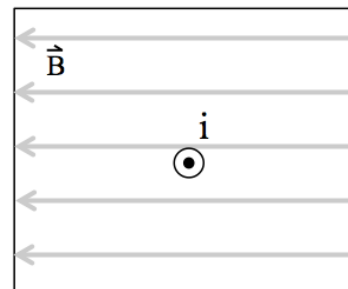

D) Current out of the page, B-Field left

Group #

Useful Expressions:

$$F_{B,\text{particle}} = qvB\sin\theta \quad (\text{Do not include the sign of } q - \text{ use the right hand rule to determine the direction of the force.})$$

$$F_{B,\text{wire}} = i l B \sin\theta$$

$$r = \frac{mv}{qB}$$

Reflect on the experience you've had so far with today's topic. What sorts of notes might you want to write on a note sheet for the exam (which you can test out by using for the rest of the worksheet and on this week's homework and quiz too)?

3) For the two following equations (the first is the magnetic force on a particle moving in a B-field and the second is the magnetic force on a wire in a B-field) fill in the missing variables with descriptions in your own words, not just letters.

$$F_{B,\text{particle}} = q \quad \boxed{\phantom{\text{variable}}} \quad \boxed{\phantom{\text{variable}}} \quad \sin \quad \boxed{\phantom{\text{variable}}}$$

$$F_{B,\text{wire}} = \quad \boxed{\phantom{\text{variable}}} \quad \boxed{\phantom{\text{variable}}} \quad B \sin \quad \boxed{\phantom{\text{variable}}}$$

4) Two isotopes of Iodine, I^{127} and I^{123} , are injected into a mass spectrometer, as shown. Assume both isotopes have been stripped of a single electron.

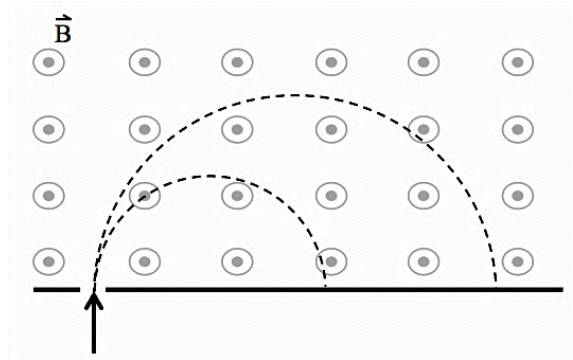

A) Which path would I^{127} follow and which would I^{123} follow? Indicate your choice on the diagram shown.

B) Take the mass of I^{123} to be 2.04×10^{-25} kg and the mass of I^{127} to be 2.11×10^{-25} kg. Both have a net charge of $+1.6 \times 10^{-19}$ C. If they are injected into the spectrometer with a velocity of 3000 m/s and the magnitude of the B-field they encounter is 0.2 T, how far apart will they land?

C) If you want to increase the distance between where the two isotopes land to make it easier to separate them, which can you change about the situation?

5) The Northern Lights (Aurora Borealis) are the product of an interaction between charged particles from the sun (the solar wind) and the Earth's magnetic field.



To understand this interaction, consider a particle with charge $+q$ that enters a B-field with a velocity as shown below. Both the B-field lines and the velocity of the particle are in the plane of this page. We want to describe the subsequent path of the particle.

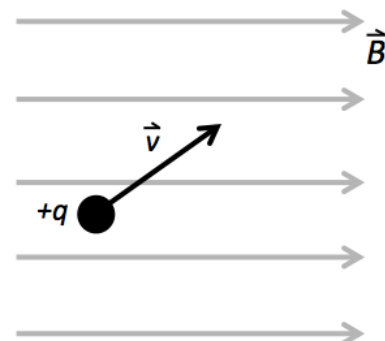

A) Make a prediction about how you think the particle will move in the field.

B) In which direction is the force that the charged particle feels due to the B-field?

C) Does your conclusion in B change the prediction you made in A? If so, how?

D) The challenge of this situation is that the force from C will change the velocity of the particle, which (because the force depends on the orientation of the velocity with respect to the B-field) will change the force. One commonly used trick to get around this problem is to break the velocity up into two components – one that you know will not change over time, and one that you know will change in a predictable way.

So, with this in mind, break the velocity vector of the particle into two components, one of which will not be changed by the B-field. Remember, the two components must be separated by an angle of 90 degrees. Draw both components on the diagram of the particle above.

E) What will happen to the component you drew in D that will change? If you need help, draw the component on the picture to the right, which shows the B-field as if you were looking at it from the right side of the page.

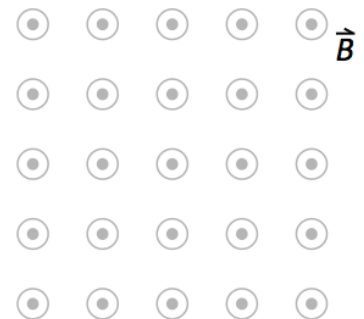

F) Re-evaluate the predictions you made in A and C. What kind of path do you think the particle will move in now?

G) Here is a drawing that represents what happens when charged particles from the sun enter the Earth's magnetic field. Does what you see match your answer to F? Use this drawing and your conclusion in F to explain why the Northern Lights occur far north of the equator.

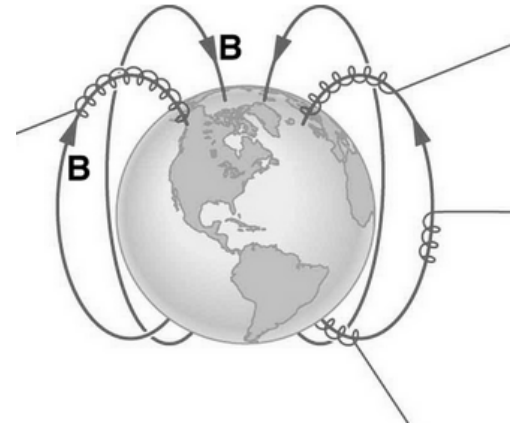

6) When animals, such as some kinds of birds and fish, use the Earth's magnetic field to navigate, they do not do so like a person might use a compass to determine north or south. Birds might go south in winter in the northern hemisphere, but they go north in winter in the southern hemisphere. Though precise mechanisms are still a topic of active research, it's currently believed that animals with magnetoperception sense the inclination of the Earth's B-field (that is, its angle with respect to the horizontal), which changes the closer or further you get to the equator. Look at the picture of the Earth's B-field shown and determine which image below (Image 1 or Image 2) is closer to the equator.

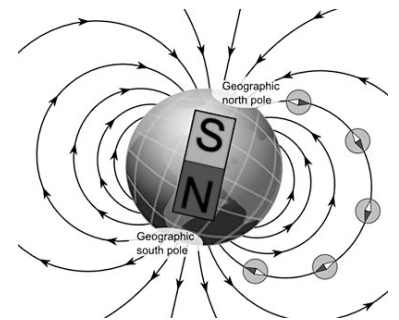

7) An airliner is flying through the Earth's magnetic field. For simplicity's sake, let's only consider the component of the Earth's field that is perpendicular to the velocity of the airliner.

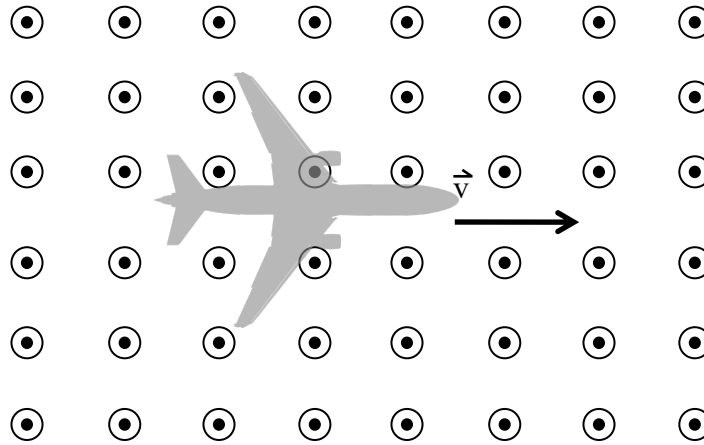

In this situation, there will be a voltage difference between the wingtips of the airliner. The larger its velocity, the greater this voltage difference will become. Why does this voltage difference exist and why does it depend on the velocity of the airliner? (Hint: Recall that aircraft are made from metal, which is a conductor.)

Your group member names:

1) What will the current-carrying wire loop in the picture do?

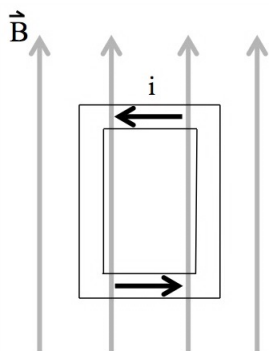

- a) The loop will remain stationary.
- b) The top of the loop will rotate up out of the page and the bottom of the loop will rotate into the page.
- c) The right side of the loop will rotate up out of the page and the left side of the loop will rotate into the page.
- d) The top of the loop will rotate into the page and the bottom of the loop will rotate up out of the page.
- e) The right side of the loop will rotate into the page and the left side of the loop will rotate up out of the page.

2) Rank the magnitudes of the magnetic fields at points P, Q, R, and S. All points are equidistant with respect to the wires.

- a) $B_Q = B_R > B_P = B_S$
- b) $B_P > B_Q > B_R > B_S$
- c) $B_Q > B_R > B_S > B_P$
- d) $B_S > B_Q = B_R > B_P$
- e) $B_R > B_S > B_P > B_Q$

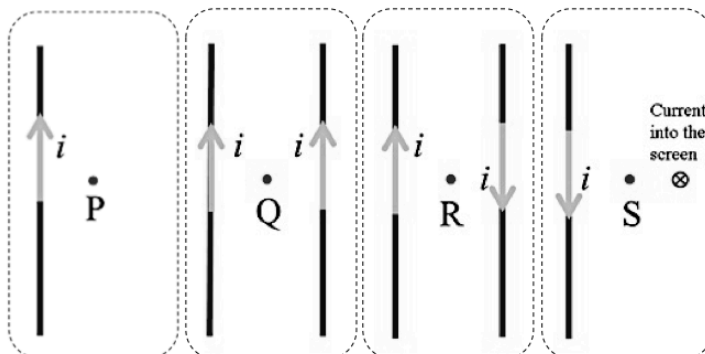

3) Two loops of the same dimensions carry current i as shown. Which configuration of magnets best matches this situation?

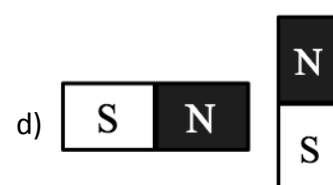
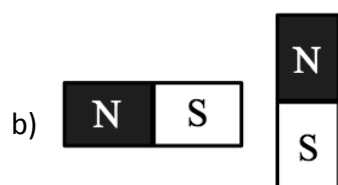
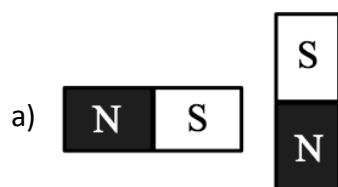
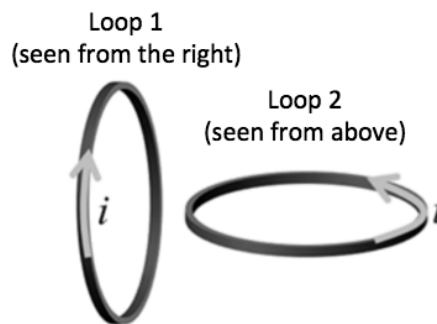

Useful Expressions:

$$\tau_{\text{loop}} = iAB\sin\theta \quad B_{\text{wire}} = \frac{\mu_0 i}{2\pi r} \quad B_{\text{solenoid}} = \mu_0 ni \quad \frac{F_{12}}{l} = \frac{\mu_0 i_1 i_2}{2\pi d}$$

Reflect on the experience you've had so far with today's topic. What sorts of notes might you want to write on a note sheet for the exam (which you can test out by using for the rest of the worksheet and on this week's homework and quiz too)?

4) A current-carrying wire loop (which is just a 1-loop solenoid) can mimic the magnetic field created by a permanent magnet (shown on the right).

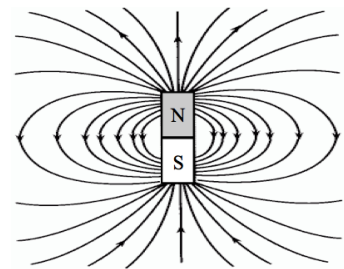

A) Which orientation of the loop would match the field pictured? (Hint, think about the direction of the B-field created at the center of the loop and remember the field always points away from the north pole and toward the south pole.)

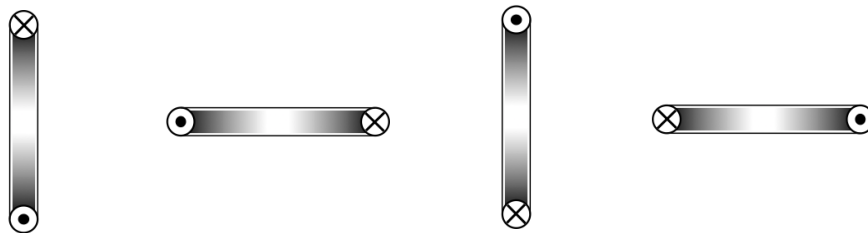

B) Use your conclusion in A to determine whether the following pairs of loops will repel, attract, or have no effect on one another.



Repel Attract No effect Repel Attract No effect



Repel Attract No effect

5) Below is a long wire with a current running through it from left to right.

A) Draw the direction of the B-field created by the current at the points A and B. If necessary, use the \otimes and \odot symbols to indicate into and out of the page respectively.

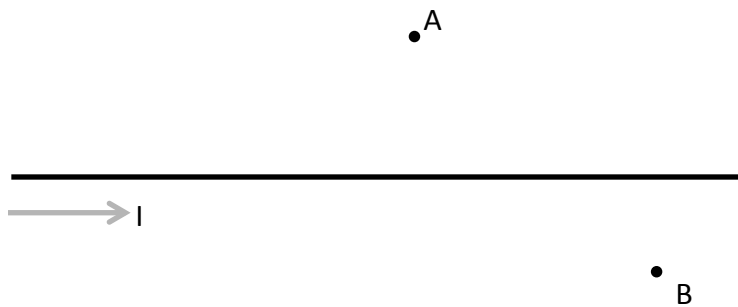

B) Draw the direction of the B-field at point C near a wire with current coming out of the page.

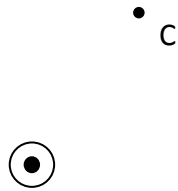

C) Draw the direction of the B-field at point D near a wire with current going into the page.



6) Each of the wire loops shown has equal area and carries the same current in the direction indicated.

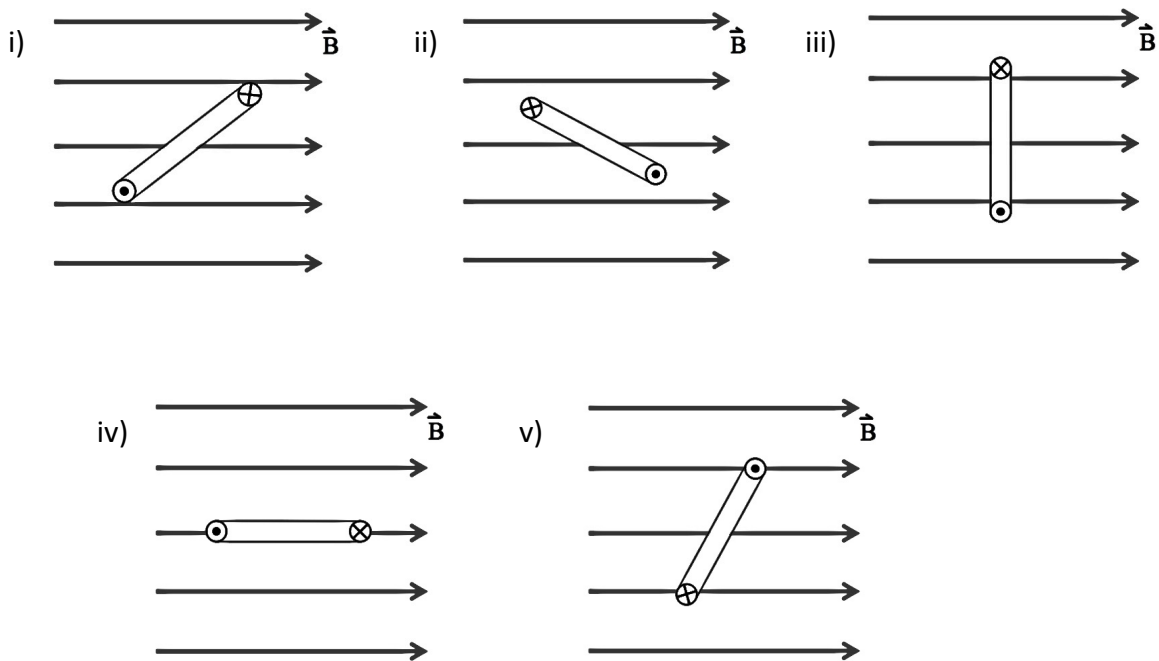

A) In each case, indicate the direction of the B-field created by the loop at the center of the loop. This is **not** the external B-field. (To find the B-field at the center, you can apply the right hand rule along the wire's circumference and see where the net field is pointing.)

B) Assuming the B-field each loop sits in is of the same magnitude, circle the case where the torque on the loop is greatest.

C) Circle the case where the torque on the loop is least.

D) Which direction will each loop rotate?

i) Clockwise or Counterclockwise

ii) Clockwise or Counterclockwise

iii) Clockwise or Counterclockwise

iv) Clockwise or Counterclockwise

v) Clockwise or Counterclockwise

7) A particular DC motor spins at 60 revolutions per minute when a given voltage is applied. What are all the changes you can make to get the motor to spin faster?

Electromagnetic Induction – Group Sheet
 Physics 104 – General Physics

Your group member names:

1) A loop is in the magnetic field of a bar magnet. Which of these would not change the magnetic flux through the loop?

- a) Tilting the loop around a vertical or horizontal axis
- b) Moving the loop toward or away from the magnet
- c) Changing the loop area by increasing or decreasing its radius
- d) Spinning the loop clockwise or counterclockwise
- e) Moving the loop from side to side
- f) Moving the magnet

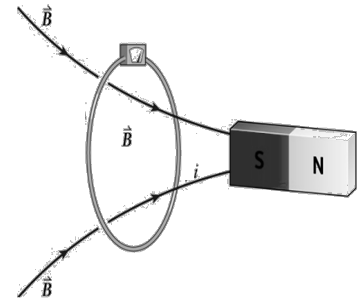

2) If you move the magnet shown to the right, what can you say about the flux through the wire loop?

- a) The flux will increase.
- b) The flux will decrease.
- c) The flux will not change.

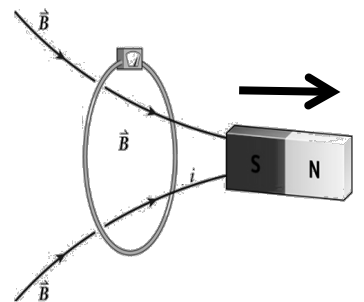

3) Flux is not really a vector, but we can imagine it as an arrow whose length indicates the amount of magnetic flux passing through an area. Below is just such an arrow representing the initial flux through the wire loop before you start moving the magnet. Draw in the final flux through the loop after the magnet moves and the change in flux between the initial and final positions of the magnet in the next two boxes.

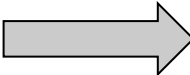

Initial flux (ϕ_0)

Flux after magnet moves (ϕ_f)

Change in flux ($\Delta\phi$)

4) In which direction will the induced magnetic field be at the center of the loop in order to resist the change in the flux?

- a) Right
- b) Left
- c) There will be no induced magnetic field

Electromagnetic Induction
Physics 104 – General Physics

Useful Expressions:

$$\Phi_B = AB\cos\theta \quad (\text{where } \theta \text{ is the angle between the field and a normal to } A)$$

$$\varepsilon = -N \frac{\Delta\Phi_B}{\Delta t} \quad \varepsilon_{AC} = \omega NAB\sin(\omega t + \phi) \quad i_{AC} = (\omega NAB/R) \sin(\omega t + \phi)$$

Reflect on the experience you've had so far with today's topic. What sorts of notes might you want to write on a note sheet for the exam (which you can test out by using for the rest of the worksheet and on this week's homework and quiz too)?

5) Experiments to study vision often need to track eye movements. One way of doing so is to have the person sit in a magnetic field while wearing contact lenses with a coil of very fine wire circling the edge. A current is induced in the coil each time the person rotates their eye. Imagine a 20-turn, 6.0-mm-diameter coil of wire circles the person's cornea while a 1.4 T magnetic field is directed as shown in the figure.

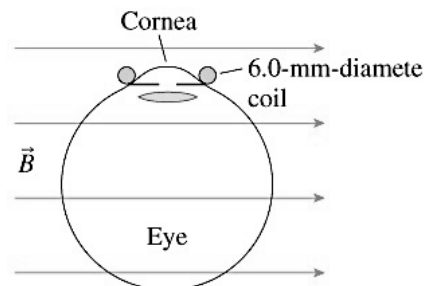

A) What are the initial and final fluxes through the coil if the person shifts their gaze by 6° in 0.35 s?

B) What emf is induced in the coil? (Note that in cases where there is more than one loop in a coil, the emf is increased by the number of coils).

Electromagnetic Induction
Physics 104 – General Physics

6) A magnet is held above a conducting loop with its N pole pointed down as shown. We will raise the magnet and ask what that does to the loop in terms of currents and forces.

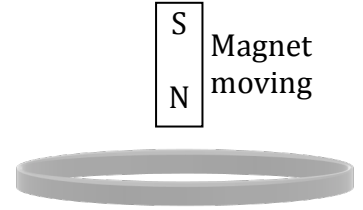

A) Draw the \vec{B} field lines inside the loop due to the magnet. Explain.

B) As you raise the magnet does the external flux, Φ_{ext} , increase, decrease or remain the same? Explain.

C) As you raise the magnet is there an emf, \mathcal{E} , generated around the loop? Explain.

D) As you raise the magnet is there an induced \vec{B} field, \vec{B}_{ind} , inside the loop? If so which way does it point? Explain.

E) As you raise the magnet is there an induced current, i_{ind} , around the loop? If so indicate its direction on the figure above. Explain.

F) Look at your answer to D and draw a magnet in the dashed oval that will behave just like the loop. Explain.

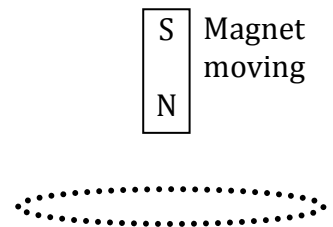

Electromagnetic Induction
Physics 104 – General Physics

G) Finally, as the magnet is moving up, what is the direction of the force on the loop? Explain.

7) A conducting loop is in a static magnetic field as shown at right. The \vec{B} field is zero outside the box.

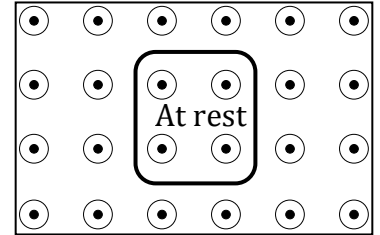

A) Does this situation cause current to flow around the loop? If so, which direction? Explain.

B) Now the loop moves from left to right through the field as shown. For the three situations shown, state whether or not there will be current flowing around the loop. Explain.

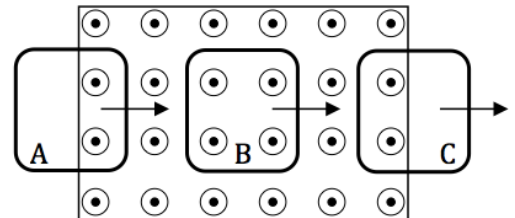

C) Indicate the direction of the loop's current for the case(s) where an induced current is produced. Explain. (Hint: You will need a RHR.)

Electromagnetic Induction
 Physics 104 – General Physics

D) Plot the flux, Φ , the induced current, i , and the EMF, \mathcal{E} as a function of time. Take out of the page (or counterclockwise) as positive. At $t = 0$ s the loop's right edge is just entering the field, at $t = 1$ s the loop is at location A, at $t = 4$ s the loop is at location B, at $t = 7$ s the loop is at location C, and at $t = 8$ s the loop's left edge has just exited the field.

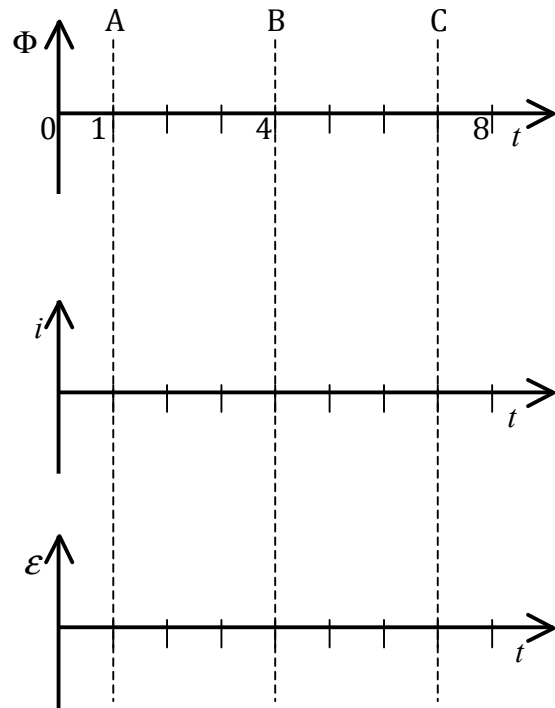

8) Consider the conducting loop and solenoid shown. When the switch is closed the solenoid current increases quickly from 0 A to 1 A and then remains steady at 1 A.

A) On the diagram indicate the direction of the current around the solenoid with the switch closed.

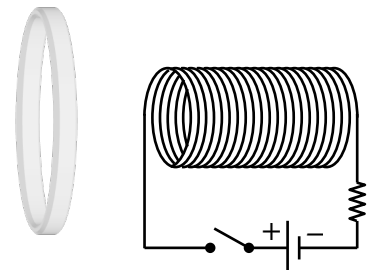

B) On the diagram indicate the direction of the \vec{B}_{sol} field caused by the solenoid, at the center of the loop. Which RHR did you use?

Electromagnetic Induction
Physics 104 – General Physics

C) Will there be an induced current in the loop? Pick an answer and justify your choice.

- Yes, but only while the switch remains closed.
- Yes, but only after the current has reached the 1 A maximum.
- Yes, but only while the current in the solenoid is increasing.

9) An application of magnetic induction is magnetic braking, a method used to slow moving (conducting) objects with magnets. To show this let's consider a magnet dropped into a metal tube.

To help understand what happens to this magnet, think about three "loops" (that is, pieces of the metal tube). Use what you know about the currents that will be induced in these three "loops" to explain why the magnet will experience a braking force upward.

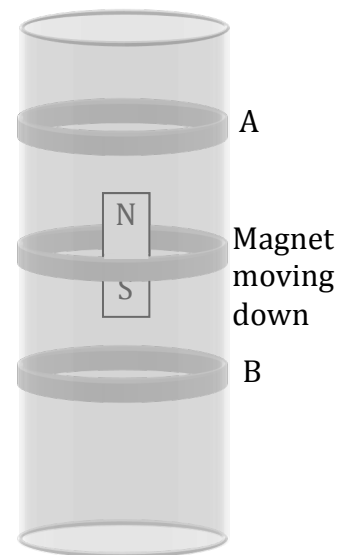

Reflect on the experience you've had with today's topic and write below what you might want to include on a note sheet to help you on the exam (and this week's homework and quiz too):

Electromagnetic Waves – Group Sheet
 Physics 104 – General Physics

1) The human body gives off the most electromagnetic radiation at a frequency of 25 THz ($T = 10^{12}$). What wavelength does this radiation have?

- a) 7 cm
- b) 5.2 mm
- c) 36 m
- d) 160 nm
- e) 12 μm

2) Use the chart to the right to identify the wave from question 1.

- a) Microwave
- b) Gamma wave
- c) Infrared wave
- d) Ultraviolet wave
- e) Visible wave

3) If you triple your distance from a radio transmitter, by what factor does the intensity of the radio waves you receive change?

- a) Decreases by a factor of 3
- b) Decreases by a factor of 9
- c) Increases by a factor of 3
- d) Increases by a factor of 9
- e) Doesn't change

Your group member names:

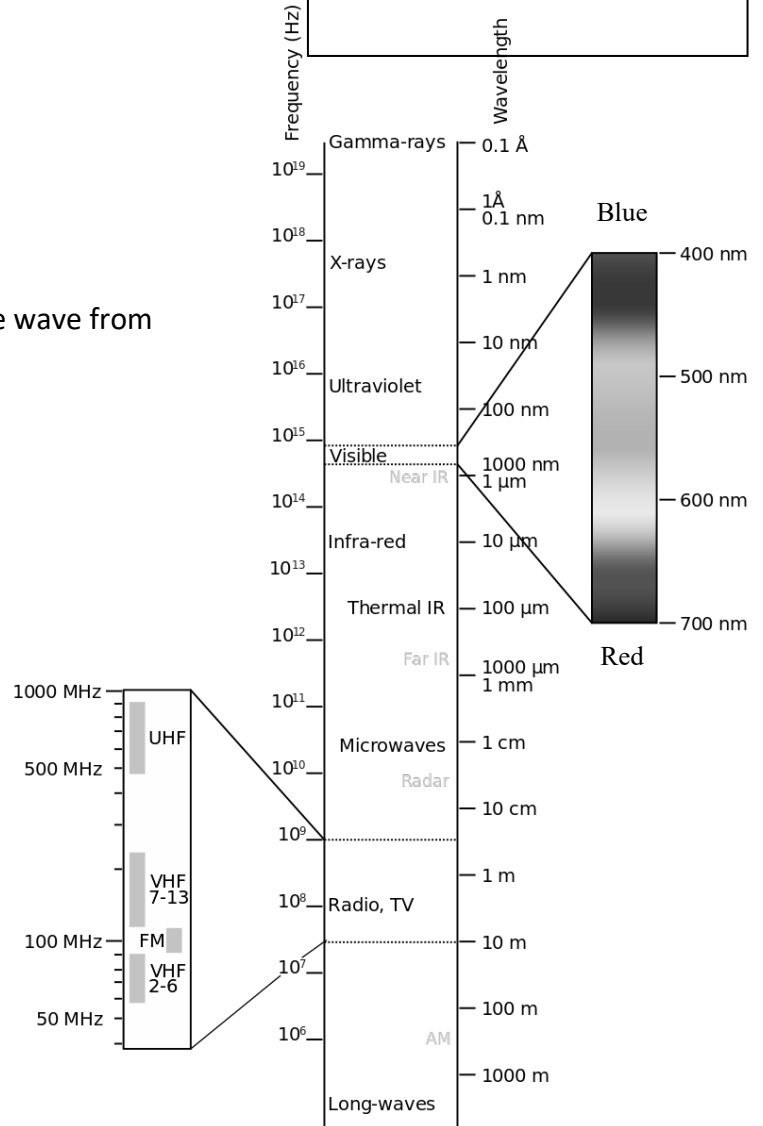

Electromagnetic Waves
Physics 104 – General Physics

Useful Expressions:

$$c = f\lambda \quad \text{in vacuum, } c = 3 \times 10^8 \text{ m/s} \quad E_0 = cB_0$$

$$I = (\text{Energy/time})/\text{Area} = \text{Power/Area} = c\epsilon_0 \frac{E_0^2}{2} = \frac{cB_0^2}{2\mu_0} = \frac{E_0B_0}{2\mu_0}$$

Reflect on the experience you've had so far with today's topic. What sorts of notes might you want to write on a note sheet for the exam (which you can test out by using for the rest of the worksheet and on this week's homework and quiz too)?

4) Three electromagnetic waves are shown below:

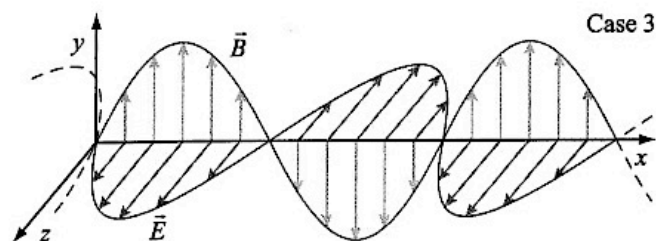
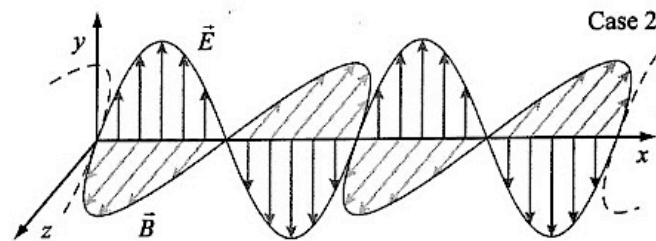
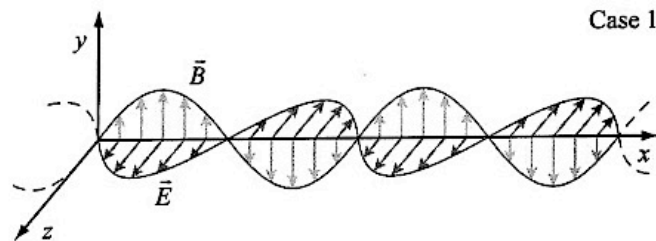

Electromagnetic Waves
Physics 104 – General Physics

A) Rank the following quantities for the three waves:

Speed (v_1, v_2, v_3) _____

Wavelength ($\lambda_1, \lambda_2, \lambda_3$) _____

Frequency (f_1, f_2, f_3) _____

Intensity (I_1, I_2, I_3) _____

B) If the wave in case 2 were green light, could the wave in case 3 be red light or blue light? Explain your choice.

C) Suppose you're using a thin conducting wire as an antenna to receive each of these magnetic waves. Describe the orientation of the wire in each case that would provide the best reception. (Hint: Think about how charges will move in the wire in response to the waves.)

5) It is a general rule that you cannot use a wave to detect anything that is smaller than the wavelength of the wave.

A) What is the size of the smallest object that you can see with visible light?

B) If you wanted to image smaller objects, what sorts of electromagnetic radiation would you use?

Electromagnetic Waves
Physics 104 – General Physics

- C) Most radar can detect objects that are 30 cm in size or larger. What is the frequency of EM radiation used by such radar?
- D) A similar rule applies to structures that you use to detect EM waves – they should be similar in size to the wavelenths of the waves they are meant to detect. Use this fact to explain why no biological organisms rely primarily on radio waves to sense their environment.
- 6) The power output of the sun in the form of EM waves is 3.85×10^{26} W. The Earth is a distance of 1.5×10^{11} m from the sun.
- A) What is the intensity of the sun's light at the location of the Earth? (Hint: Remember that intensity is power per unit area. So what is the area over which the sun's light is spread at the location of the Earth?)
- B) What is the total power delivered to the Earth by the sun? (Hint: The light that the Earth collects is the same as the light that falls on a disk with the radius of the Earth, 6.4×10^6 m.)

Electromagnetic Waves
Physics 104 – General Physics

C) Assuming that 30% of the sun's light that is incident on the Earth is reflected back into space, how much available power reaches the surface of the Earth in the form of sunlight?

D) The average global energy usage per capita is about 3.3×10^{11} Joules per year. If a solar panel is able to convert 20% of the sunlight it collects into usable power, how large would one need to be in order to supply the average citizen of Earth with the power they consume?

7) Imagine light incident on a series of three absorptive polarizers. The first has an axis of transmission oriented vertically. The second has an axis of transmission oriented at 30° from the vertical. The last has an axis of transmission oriented horizontally.

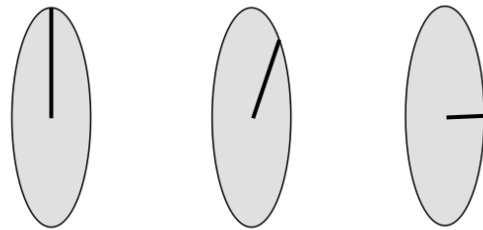

A) If unpolarized light with intensity I_0 is incident on the first polarizer (the left-most one in the picture), what is the intensity of the light in terms of I_0 once it passes through but before it hits the second polarizer?

B) What is the intensity of the light in terms of I_0 after the second polarizer?

C) What is the intensity of the light in terms of I_0 after the third polarizer?

D) What happens to the intensity of the light passing through the final polarizer if you rotate the middle polarizer so that it makes a 60° angle with the vertical?

E) What happens to the intensity of the light passing through the final polarizer if you remove the middle polarizer? Explain your answer.

8) Let's explore a very simple model of one way in which EM waves interact with matter. Imagine an EM wave of some wavelength and frequency traveling from the left toward the object of mass M that has an electric charge of Q . The image shows the oscillating E-field of the wave. The oscillating B-field is perpendicular to the page.

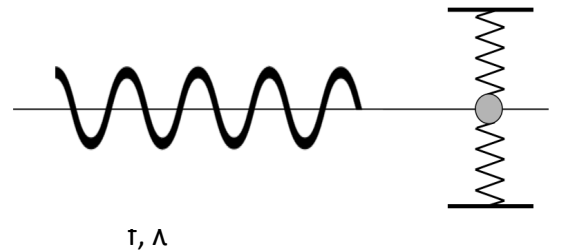

Meanwhile, M is connected to two springs, one above, and one below. Before the wave reaches it, M is in the equilibrium position – that is, neither spring is stretched or compressed.

A) Suppose the EM wave has moved forward to the position shown at the right. Describe the force on M as the wave moves an additional one-half wavelength.

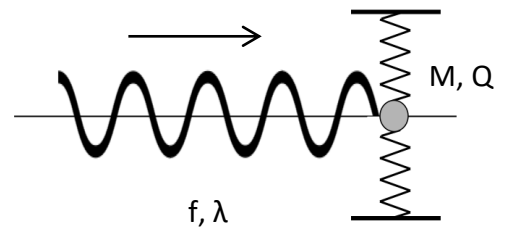

B) What will the force be on M as the wave moves one more half wavelength.

Electromagnetic Waves
Physics 104 – General Physics

C) What will the motion of M be over time as the EM wave moves past it?

D) Use your description in C to explain how an EM wave can heat up a substance.

E) For any oscillator (object M at the end of springs or your swinging pen/pencil), there is a special frequency. If you push it at this frequency, called the **resonant frequency**, it will strongly respond. If you push it at another frequency, it will not respond very well. Use the fact that the system of M and the springs to which it is connected will have a resonant frequency to explain why some materials will absorb EM waves of some frequencies more strongly than others.

9) The polarizing angle (Brewster angle) in air for a certain object is 67.4° .

A) Calculate the index of refraction for this object.

Material	N
Ice	1.3
Glass	1.5
Cubic zirconia	2.2
Diamond	2.4

B) When you look at the table given, what material is this object probably made of?

1) When a ray of light goes from one medium to another with a different index of refraction, which properties of the light change? Select all that apply.

- a) Speed
- b) Frequency
- c) Wavelength
- e) None of the above

2) When a ray of light moves from a medium with a low index of refraction to a high index of refraction, how will it refract?

- a) It will bend toward the normal to the surface between the two media.
- b) It will bend away from the normal to the surface between the two media.
- c) It won't refract – it will always be totally internally reflected

The angle of refraction depends on ... (mark all that apply)

- a) the frequency of the light.
- b) the wavelength of the light.
- c) the material of the medium.
- d) the color of the light.

3) For the case of total internal reflection, mark all the true statements.

- a) Total internal reflection can happen when the incident ray goes from a medium with high n towards a medium with a lower n .
- b) Total internal reflection can happen when the incident ray goes from a medium with a low n towards a medium with a higher n .
- c) Total internal reflection when the angle of incidence is smaller than the critical angle.
- d) The critical angle of total internal reflection depends only on the medium where the incident ray is.
- e) The critical angle of total internal reflection depends on the media on both sides of the interface.

Reflection, Refraction, & Dispersion
Physics 104 – General Physics

Useful Equations:

$$\theta_1 = \theta_2 \quad (\text{reflection}) \quad n = \frac{c}{v_{\text{light}}} \quad n_1 \sin \theta_1 = n_2 \sin \theta_2 \quad (\text{refraction})$$

Reflect on the experience you've had so far with today's topic. What sorts of notes might you want to write on a note sheet for the exam (which you can test out by using for the rest of the worksheet and on this week's homework and quiz too)?

4) Two mirrors are at right angles to one another. A light ray is incident on Mirror 1 at an angle of 40° with respect to the normal to the surface, as shown.

A) What is the angle of reflection from Mirror 2 with respect to the normal to the surface?

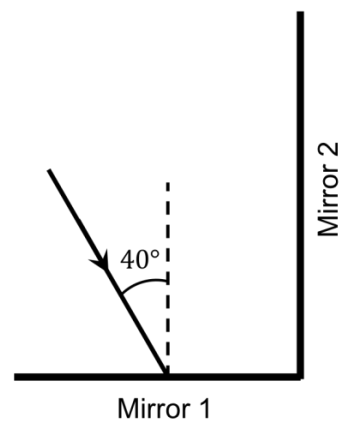

B) What is the angle between the ray incident on Mirror 1 and the one reflected from Mirror 2?

Reflection, Refraction, & Dispersion
 Physics 104 – General Physics

5) Consider a ray of light incident on a surface as shown.

A) Fill in the boxes with the correct terms.

B) If n_1 and n_2 are the indices of refraction in medium 1 and 2 respectively, write an expression for the ratio of $\sin\theta_1/\sin\theta_2$ in terms of n_1 and n_2 .

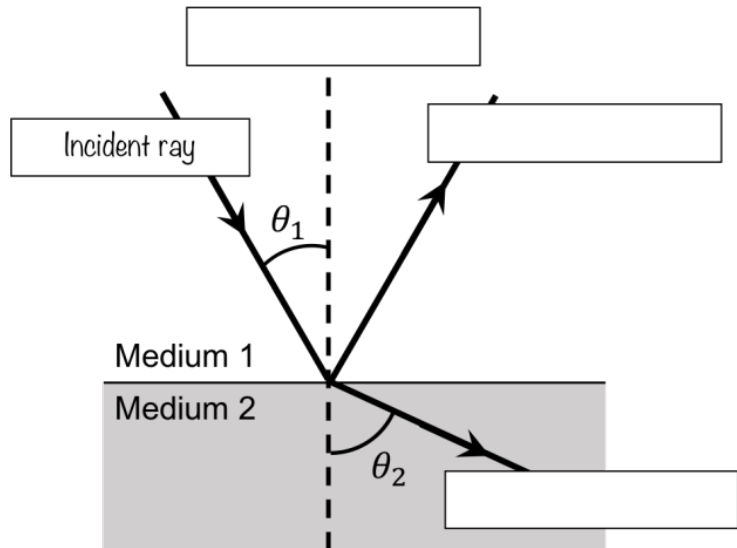

C) Based on the image above, is n_2 smaller or larger than n_1 ?

D) Is the speed of light in medium 2 higher or lower than in medium 1?

E) If $n_1 = 1.5$ and $n_2 = 3.0$, what is the speed of light in medium 2?

6) A ray of light in air ($n = 1.00$) falls on the upper surface of two parallel-sided slabs of transparent material, as shown.

A) What is the angle of refraction ϕ in the lower slab?

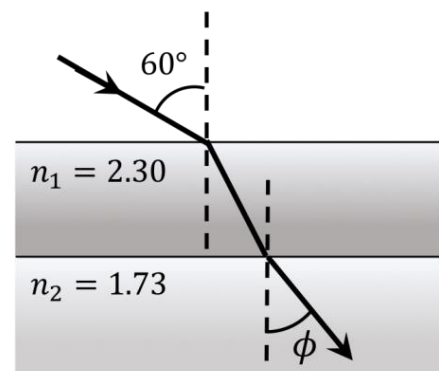

B) What would ϕ be if you doubled n_1 ?

7) In a fish tank filled with water ($n_2 = 1.33$) a light ray is directed towards the surface at an angle θ such that no light enters the air above the tank and the refracted light is parallel to the surface of the water.

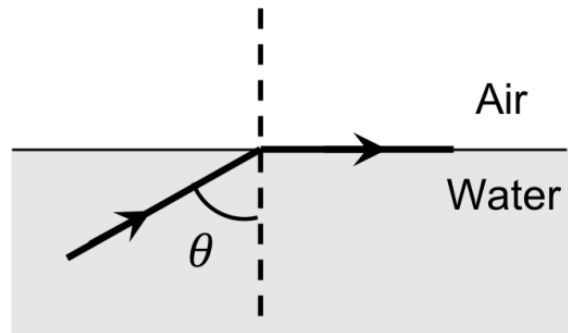

A) What is the critical angle needed to fulfill this condition?

B) What happens to the ray when it hits the water-air interface at an angle that is larger than θ ?

C) Suppose we place a glass plate ($n_3 = 1.5$) on top of the water, as shown. Does adding the glass plate make a difference to the critical angle θ ?

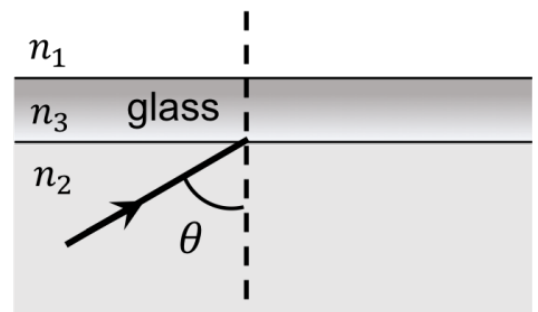

Reflection, Refraction, & Dispersion
Physics 104 – General Physics

D) What happens to the incident light ray (still with the same angle of incidence you computed in part 'A') when it hits the new water-glass interface? Draw the ray in the diagram to the right and calculate the angle of refraction.

E) What will happen to the refracted ray when it passes through the glass plate and hits the glass-air interface? Draw the ray in the diagram above and calculate the angle of refraction.

F) OK – we're done with that first ray (whew!). Suppose a different light ray is incident on the water-glass interface from below at an angle of 30° to the normal of the surface. What is the final angle of refraction of the ray after passing through the glass plate and entering the air?

G) What happens to this angle if we use a different kind of glass plate with index of refraction 1.9?

H) While a fraction of the incident light is refracted, another fraction of the light is reflected at the water-glass interface. What is the angle between this reflected ray (in water) and the refracted ray (in air)?

8) Two prisms are refracting light from a monochromatic light source such that both rays meet again after refraction

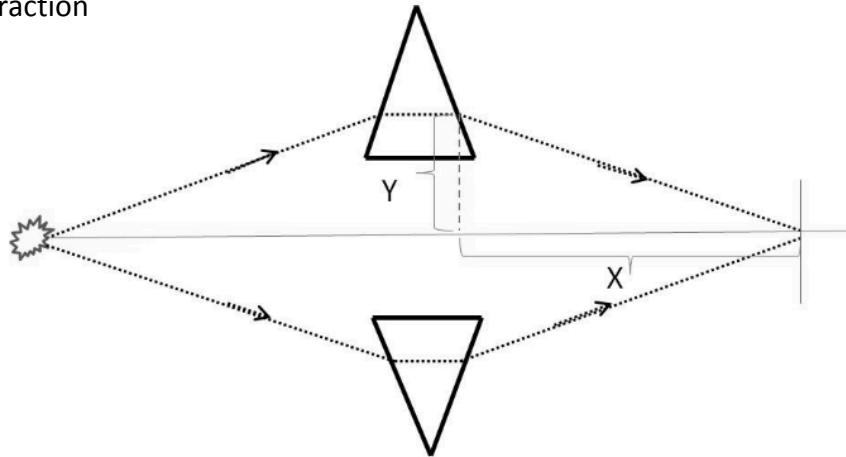

A) Say the light source emits blue light in the sketch above. Would rays of red light meet closer to the light source or farther away from the light source than the blue light? Why?

B) Let's assume that the rays inside the prisms are horizontal and that the angle at the top or bottom tip of the prisms is 40° (which also means the angles at the base of the prisms, parallel to the centerline, are 70° each). The rays inside both prisms are a distance of $Y = 5$ cm away from the centerline as indicated in the sketch. The indices of refraction in the prisms are 1.55 for blue light and 1.53 for red light. What is the distance X where the two rays meet for blue light and for red light? (Hint: Start by drawing a sketch of one of the prisms with rays.)

C) What is the difference between the two distances, X_{blue} and X_{red} ?

D) This calculation is only an approximation. Why? What did we neglect?

Your group member names:

Interference – Group Sheet
Physics 104 – General Physics

1) Which analogy best describes the concept of superposition?

- a) You and I each have \$10. We both invest in the same opportunity and a little while later combine our earnings so that we have a total of \$30.
- b) We have 10 cookies between us. We each eat 5 so that there are no cookies left.
- c) I have 7 stones and you have 5 stones. I stack mine on at a particular spot on a beach. You walk by and stack yours on top of the ones I piled up.
- d) I type a paragraph and give it to you to revise. You remove one sentence and add another.

2) When there is destructive interference between two light waves at a point in space, why does it look dark?

- a) Because the troughs of both waves are always lined up.
- b) Because the intensities of both waves are zero.
- c) Because the light bends around that point in space.
- d) Because the E- and B-fields of both waves cancel each other out.
- e) Because there is no phase difference between the waves

3) Each pattern shown would appear on a screen when monochromatic light of wavelength λ first passes through a narrow slit of width a and then hits a screen. The dark areas in the figures below represent the brightest areas on the screen. In which case does the slit have the greatest width?



4) A double-slit experiment is performed with three different colors of light: red, green, and blue. Rank the colors by the distance between adjacent bright fringes from largest to smallest.

- a) blue > green > red
- b) red > blue > green
- c) red > green > blue
- d) The fringe separation will be the same for each.
- e) We can't tell unless we know the slit separation.

Useful Equations:

Small angles: $\sin \theta \approx \tan \theta \approx \theta$ for small angles measured in radians

Double-slit interference:

$$\Delta\text{path (constr)} = d\sin\theta_{\text{bright}} = m\lambda \quad y_{\text{bright}} = \frac{\lambda L}{d} m \quad m = 0, \pm 1, \pm 2, \dots$$

$$\Delta\text{path (destr)} = d\sin\theta_{\text{dark}} = (m + \frac{1}{2})\lambda \quad y_{\text{dark}} = \frac{\lambda L}{d} (m + \frac{1}{2}) \quad m = 0, \pm 1, \pm 2, \dots$$

Single-slit interference (diffraction) and resolution:

$$\sin\theta_{\text{dark}} = \frac{m\lambda}{w} \quad m = 1, 2, 3, \dots \quad \sin\theta_R = 1.22 \frac{\lambda}{d}$$

Reflect on the experience you've had so far with today's topic. What sorts of notes might you want to write on a note sheet for the exam (which you can test out by using for the rest of the worksheet and on this week's homework and quiz too)?

5) The image at right shows the viewing screen in a double-slit experiment. For parts A-C, will the fringe spacing increase, decrease, or stay the same? Explain your answer in each case.

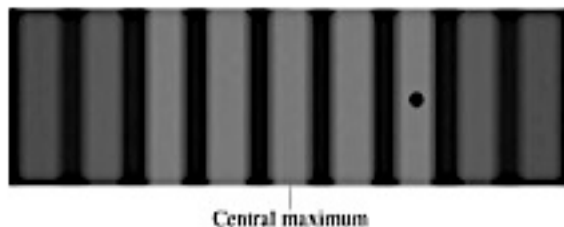

A) The distance to the screen is increased.

B) The spacing between the slits is increased.

C) The wavelength of the light is increased.

D) Suppose the wavelength of the light is 500 nm. The point on the screen marked with a dot is how much further from the left slit than from the right slit?

Interference
Physics 104 – General Physics

6) The picture below shows two sources of light waves that are interfering. The thick lines are peaks in the waves (that is, where the E- and B- fields are maximum in one direction). The thin lines are troughs in the waves (that is, where the E- and B-fields are maximum in the opposite direction).

A) Which of the points from A to G are spots of constructive interference?

B) Which of the points from A to G are spots of destructive interference?

C) Are there any points that are neither destructive or constructive interference? What would you see if you put a screen at that point?

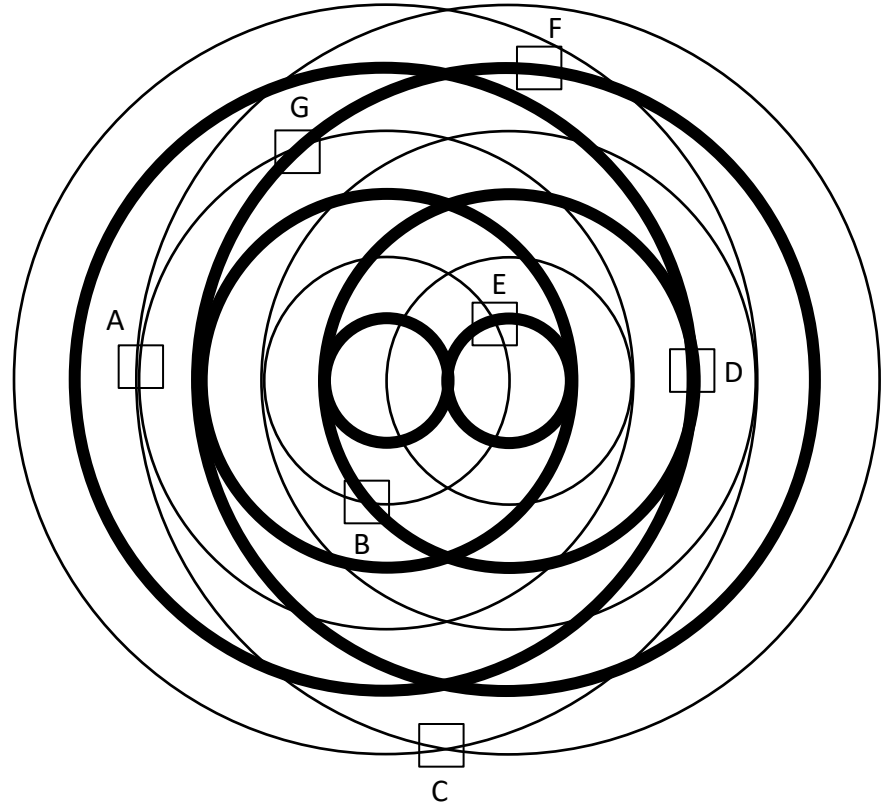

D) Choose one of the points above and determine the path length difference (in terms of λ) from each source. Then compute the path length difference.

E) Are there any points at which neither constructive nor destructive interference is occurring? What would you see if you placed a screen at those points?

Interference

Physics 104 – General Physics

7) The limit to the eye's acuity is related to diffraction by the pupil.

A) What is the angle between two just-resolvable points of light for a 3-mm diameter pupil, assuming an average wavelength of 550 nm?

B) Take your result to be the practical limit for the eye. What is the greatest possible distance a car can be from you if you can resolve its two headlights, given they are 1.3 m apart?

C) What is the distance between two just-resolvable points held at arm's length (0.8 m) from your eye?

D) How does your answer to C compare to details you normally observe in everyday circumstances?

E) If you want to maximize your ability to distinguish two points, what kind of light should you use to illuminate them?

Interference

Physics 104 – General Physics

8) You shine monochromatic light of frequency 6×10^{14} Hz through two small slits separated by 2×10^{-4} m. You set up a screen 4 m away to observe the interference pattern.

A) What is the path difference between light from the two slits to the central bright fringe?

B) What is the path difference between light from the two slits to the first dark fringe? At what angle with respect to the horizontal does this fringe occur?

C) What is the path difference between light from the two slits to the third ($m = 3$) bright fringe? How far away is this fringe from the central bright fringe on the screen?

Interference
Physics 104 – General Physics

9) Imagine the two dots below are two coherent light sources (like two slits in a screen illuminated by the same source). The light has a wavelength equivalent to $1/2$ inch, as depicted in the box. The horizontal line represents a screen that both sources are illuminating.

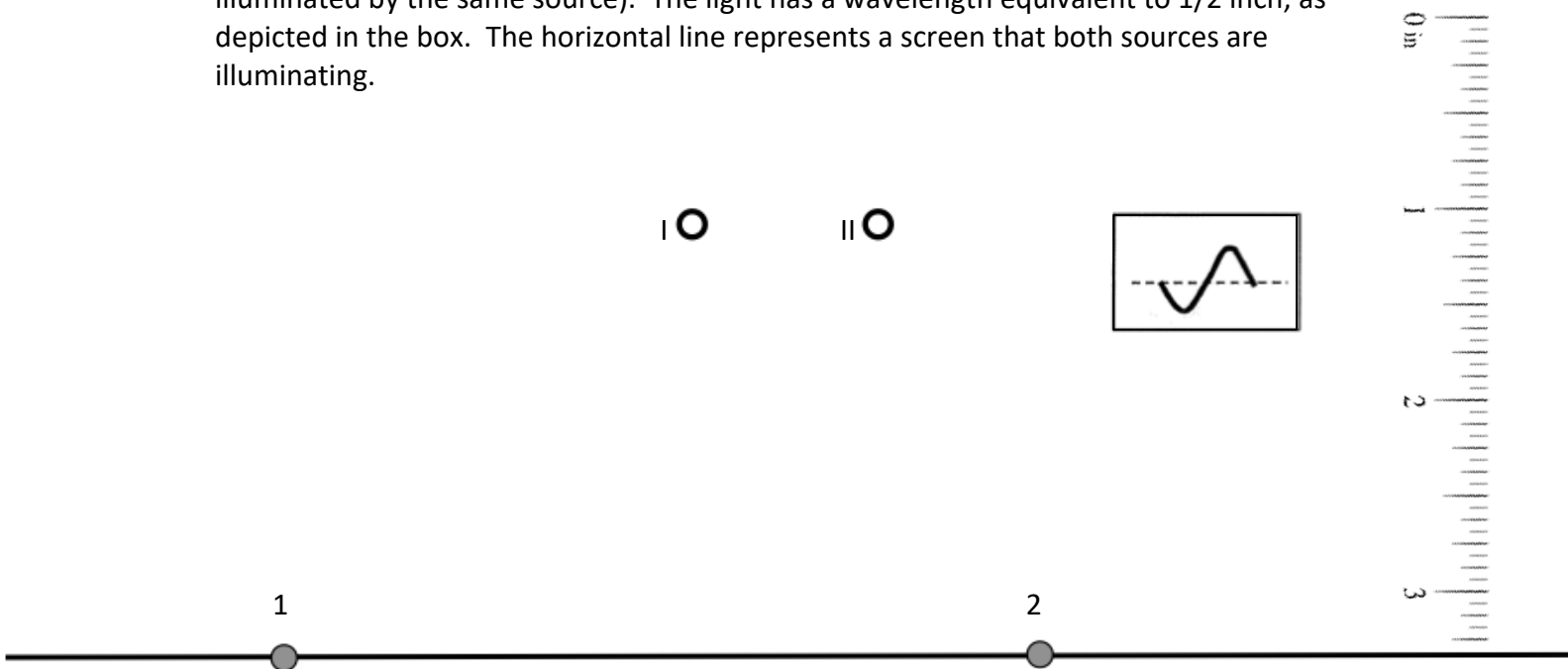

A) Draw a line to indicate the path that light from source I takes to spot #1. Sketch in the number of wavelengths that fit on this line as best you can. Now do the same for the path from source II to spot #1. Do you think this is a bright spot, a dark spot, or in between?

B) Now, measure the path light takes from source I to point #1 on the screen. Then measure the path light takes from source II to point #1 on the screen. Were you right in part B? Is this a bright, dark, or in-between spot?

C) Repeat A and B for spot #2. Is it a bright, dark, or in-between spot?

Interference
Physics 104 – General Physics

10) Match the structure of points (for instance, atoms) with the light pattern that would be produced if x-rays were passed through that structure. (Note: Each point will behave as a source of light and the light patterns will be the product of both diffraction and interference.)

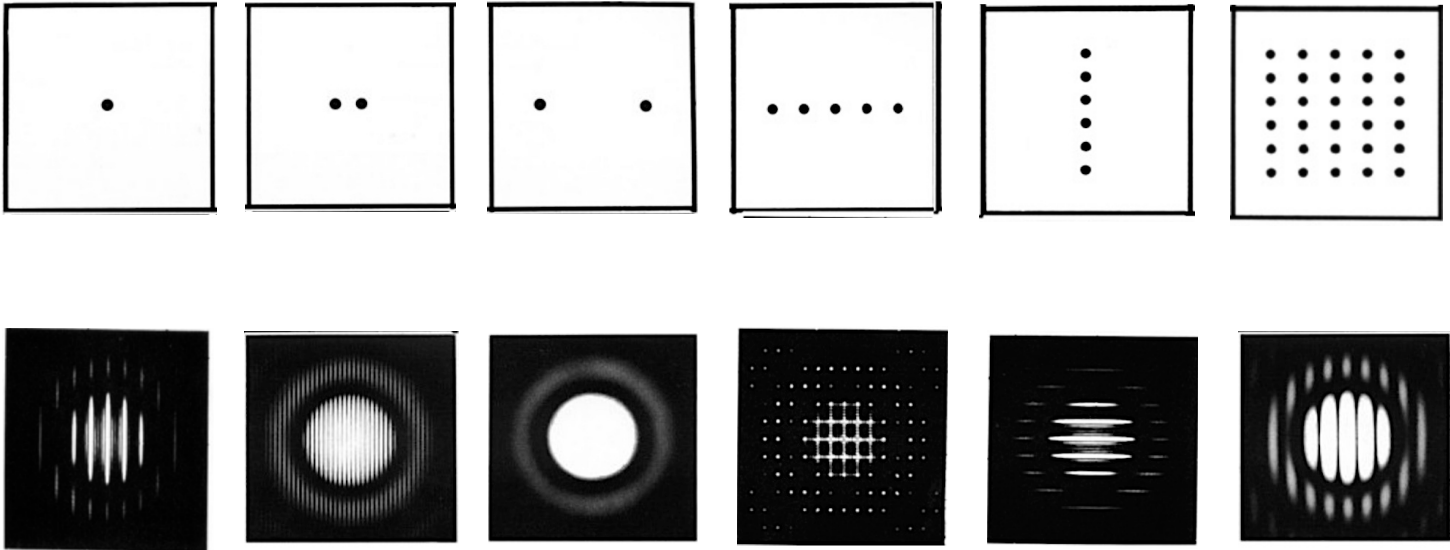

Thin Film Interference and Interferometry – Group Sheet
Physics 104 – General Physics

Your group member names:

1) In what way can you create a phase difference between two monochromatic coherent beams of light? More than one answer may be correct.

- a) Reflect one beam off a surface with a lower index of refraction.
- b) Change the intensity of one of the beams.
- c) Make one beam travel a different distance than the other.
- d) Reflect one beam off a surface with a higher index of refraction.
- e) Reflect both beams off a mirror.

2) An unknown film floating on water ($n_{\text{water}} = 1.33$) appears dark at its edges where it has the least thickness. You know this is due to thin film interference, but the thickness is almost zero; there must be a phase shift in one of the two reflections. You conclude that the index of refraction of the unknown film must be:

- a) Less than 1.33
- b) Greater than 1.33
- c) Equal to 1.33

3) Two parallel light rays, initially in phase and having a 500 nm wavelength, reach a detector after one of the rays passes through a 10 cm long block of glass with an index of refraction = 1.5. (The situation is sketched at right, although not to scale.) The total number of wavelengths shifted between the two rays when they reach the detector is

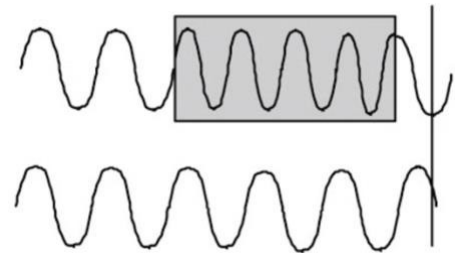

- a) 100,000
- b) 200,000
- c) 300,000
- d) 500,000

Thin Film Interference and Interferometry
Physics 104 – General Physics

Useful Equations:

When a light wave with wavelength λ_0 enters a new medium with index of refraction n , $\lambda_n = \frac{\lambda_0}{n}$

Hard reflection \Rightarrow phase shift of $\frac{\lambda}{2}$ Soft reflection \Rightarrow phase shift of 0

For thin film interference

$$2nD = \left(m + \frac{1}{2}\right)\lambda \quad \text{or} \quad 2nD = m\lambda \quad m = 0, 1, 2, \dots$$

Reflect on the experience you've had so far with today's topic. What sorts of notes might you want to write on a note sheet for the exam (which you can test out by using for the rest of the worksheet and on this week's homework and quiz too)?

4) We have two expressions for the conditions of constructive and destructive interference for light reflected from a thin film. To determine which to use in different situations, circle the correct expression in each cell of the table below.

	This expression gives the conditions of constructive interference in the specified situation.	This expression gives the conditions of destructive interference in the specified situation.
When there is one hard and one soft reflection.	$2nD = \left(m + \frac{1}{2}\right)\lambda$ $2nD = m\lambda$	$2nD = \left(m + \frac{1}{2}\right)\lambda$ $2nD = m\lambda$

Thin Film Interference and Interferometry
 Physics 104 – General Physics

When there are two hard reflections or two soft reflections.	$2nD = \left(m + \frac{1}{2}\right)\lambda$ $2nD = m\lambda$	$2nD = \left(m + \frac{1}{2}\right)\lambda$ $2nD = m\lambda$
--	--	--

5) The diagram shows four situations in which light of wavelength λ is incident perpendicularly on a very thin layer (the middle layer in each case). The indices of refraction are $n_1 = 1.5$ and $n_2 = 2.0$.

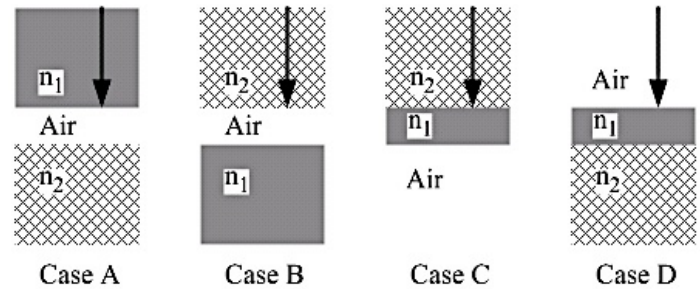

A) For each case, state whether the light reflected back up will be **bright** (due to constructive interference) or **dark** (due to destructive interference) in the limit that the middle layer approaches zero thickness. (i.e., we're going to assume that all phase shifts are due only to reflections and not to path length differences. Note that you don't have to worry about determining whether to account for path length difference or not on your own. We'll always tell you whether you need to or not).

Case A:

Case B:

Case C:

Case D:

Thin Film Interference and Interferometry
Physics 104 – General Physics

B) In Case B, what is the minimum non-zero thickness of the thin film that would produce **destructive** interference for reflected light if the wavelength of the incident light is 600 nm (measured in air). (In other words, we are NOT ignoring thickness and phase differences due to path length here. Note that ignoring a piece of a problem and then adding it in later is a common approach to complicated problems in physics.)

6) Many instances of vibrant color in biology are due to thin-film interference. For instance, imagine a transparent segment of a dragonfly's wing. It is 94.2 nm thick and is surrounded by air ($n = 1$) on both sides. The material it is made of has an index of refraction of 1.3.

A) Sketch the wing and draw the two rays that will be interfering. Label them 1 and 2.

B) Indicate whether either (or both) of the rays undergo a phase shift when it is reflected. Given your conclusion, circle the correct equation that describes the conditions for constructive interference.

$$2nt = \left(m + \frac{1}{2}\right) \lambda$$

$$2nt = m\lambda$$

Thin Film Interference and Interferometry
Physics 104 – General Physics

C) How much more does the ray that refracts through the wing travel? How many wavelengths does this distance represent?

D) What visible wavelength is most strongly reflected? Use the table below to determine what color the wing mostly appears.

Red	620 – 750 nm
Orange	590 – 620 nm
Yellow	570 – 590 nm
Green	495 – 570 nm
Blue	450 – 495 nm

E) In part D, you needed to assume $m = 0$ to find an answer. What if m was equal to something else? What is the physical description of what's happening when $m = 1$?

7) The diagram at right shows a Michelson interferometer, which is an important application of flat mirrors. The interferometer allows precision measurements of wavelengths, distances, and other quantities.

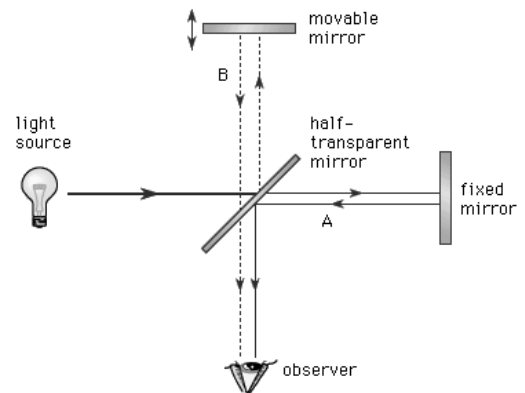

A) If you displace the movable mirror a distance d , by how much do you change the path length difference between the two arms?

Thin Film Interference and Interferometry
Physics 104 – General Physics

B) Do we need to consider differences in phase due to reflection between each arm of the interferometer? Why or why not?

C) As the movable mirror is displaced, the observed interference pattern will undergo some number of “fringe shifts” as it moves between instances of constructive and destructive interference. Suppose fringe shifts are observed when the mirror is translated a distance d . Write an equation relating d and λ .

D) Suppose the movable mirror is displaced 0.382 mm, causing 1700 fringe shifts to be observed. What is the wavelength of the laser? What color is it?

8) To save money on making aircraft invisible to radar, an inventor decides to coat them with a non-reflective material having an index of refraction of 1.20, which is between that of air and the surface of the plane. This, the inventor reasons, should be much cheaper than designing conventional stealth aircraft.

Answer three questions about this scenario:

A) What thickness should the coating be to inhibit the reflection of 4.00-cm wavelength radar?

Thin Film Interference and Interferometry
Physics 104 – General Physics

B) What is unreasonable about this result?

C) Which assumptions are unreasonable or inconsistent?

Your group member names:

1) Select all the statements that are true. The image formed by a plane mirror is:

- a) Real
- b) Virtual
- c) Inverted
- d) Upright
- e) All of the above

2) In which case is an image **not** formed by a concave mirror?

- a) When the object is at the radius of curvature.
- b) When the object is at the focal point.
- c) When the object is at a spot twice the focal length.
- d) When the object is closer than the focal point.
- e) When the object is further away than the focal point.

3) When drawing a ray diagram for a concave mirror, which ray would you **not** want to include?

- a) The ray that starts out horizontal and then is reflected back through the focal point.
- b) The ray that goes through the focal points and ends up horizontal (if the object is further away from the mirror than the focal length).
- c) The ray that starts out horizontal and then is reflected back through the point of the radius of curvature (if the object is further away than twice the focal length from the mirror)
- d) The ray that reflects off the center of the mirror.
- e) The ray that appears to come from the focal point and ends up horizontal (if the object is closer to the mirror than the focal length).

4) Can the image of an object reflected in a mirror become the object for a second mirror?

- a) Yes
- b) No

Mirrors
Physics 104 – General Physics

Useful Equations:

$$\frac{1}{d_o} + \frac{1}{d_i} = \frac{1}{f} \quad \text{lateral magnification } m = \frac{h_i}{h_o} = -\frac{d_i}{d_o}$$

$d_i > 0$ for real image

$d_i < 0$ for virtual image

$f = \infty$ for flat mirror

$f > 0$ for concave mirror

$f < 0$ for convex mirror

Reflect on the experience you've had so far with today's topic. What sorts of notes might you want to write on a note sheet for the exam (which you can test out by using for the rest of the worksheet and on this week's homework and quiz too)?

6) Your eye is located a distance $d = 20 \text{ cm}$ from a vertical arrow of height $h = 10 \text{ cm}$, which in turn is a distance $d = 20 \text{ cm}$ from a plane mirror as shown.

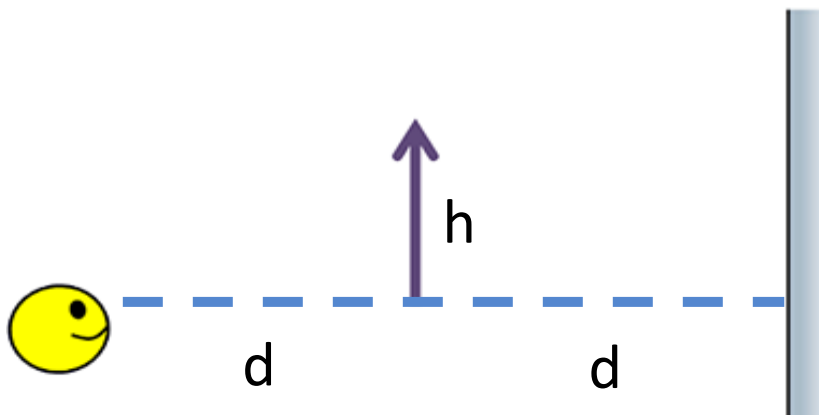

A) Draw rays to locate the position of the *image* of the arrow.

Mirrors

Physics 104 – General Physics

B) What is the *lateral magnification* of the *image* compared to the *object*?

C) As seen from your eye, what is the *angular magnification* of the image compared to the object? You will read about angular magnification next week when we discuss optical instruments. It is defined to be θ_i/θ_o , the ratio of the angle subtended by the image to the angle subtended by the object.

D) Evaluate this statement: “Since the image of an object in a flat mirror always appears twice as far away as the object itself, the magnification of a flat mirror is less than one. (That is, flat mirrors make things look smaller.)”

7) Consider an object in front of a concave mirror as shown. The solid dot is the focal point of the mirror. The open dot is the center of the radius of curvature.

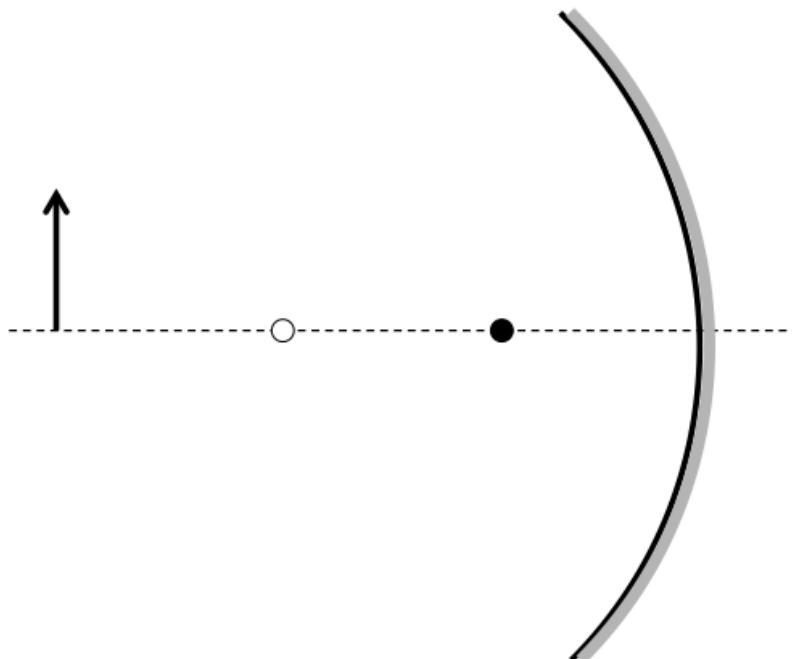

Mirrors

Physics 104 – General Physics

A) If $d_o = 6$ cm and $f = 2$ cm, what is d_i ?

B) If the height of the object is 1.8 cm, what is the lateral magnification of the image?

C) Draw a ray diagram to find the location and lateral magnification of the image. How does your diagram compare to your calculations above?

8) Consider an object in front of a concave mirror as shown. Once again, the solid dot is the focal point of the mirror. The open dot is the center of the radius of curvature.

A) If $d_o = 0.5$ cm and $f = 1$ cm, what is d_i ?

B) If the height of the object is 1 cm, what is the lateral magnification of the image?

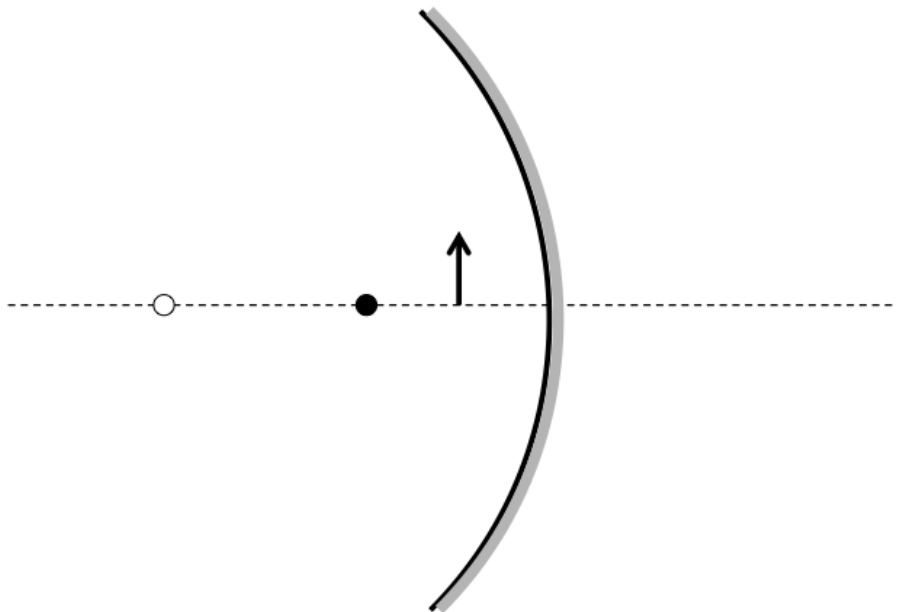

Mirrors

Physics 104 – General Physics

C) Draw a ray diagram to find the location and lateral magnification of the image. How does your diagram compare to your calculations above?

9) An object is in front of a convex mirror as shown.

A) If $d_o = 3$ cm and $f = -2$ cm, what is d_i ?

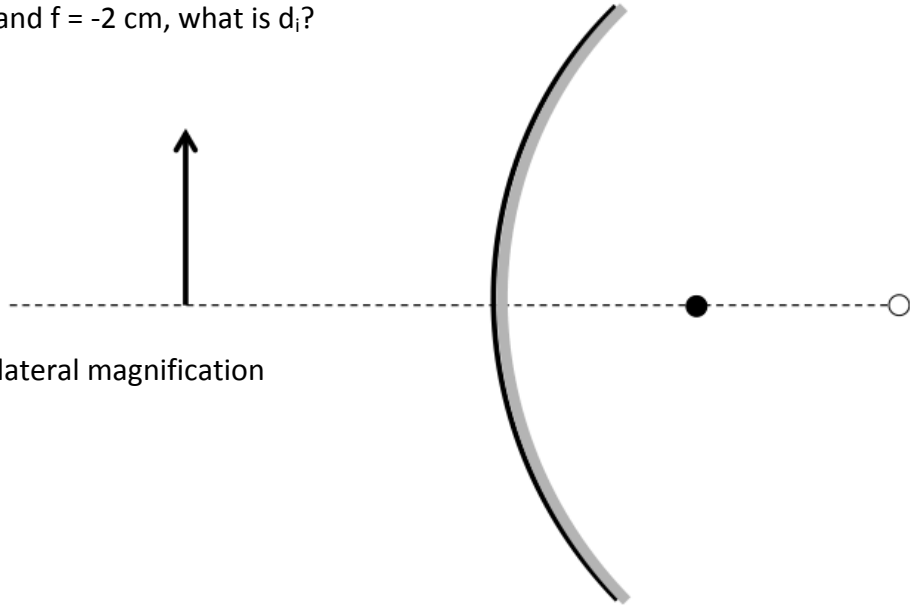

B) What is the lateral magnification of the image?

C) Draw a ray diagram to find the location and lateral magnification of the image. How does your diagram compare to your calculations above?

10) You place an object in between two perpendicular mirrors, as shown.

A) Locate the image of the object formed in the vertical mirror by drawing several rays on the diagram.

B) Locate the image of the object formed in the horizontal mirror by drawing several rays on the diagram.

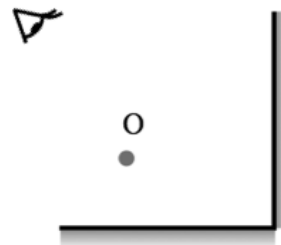

Mirrors

Physics 104 – General Physics

C) There will be a third image formed (trust us). Indicate on the picture where you think this image will appear.

D) To figure out how the third image is created, think about the object of O reflected by the horizontal mirror. Let's call it I_H . Can the eye in the above diagram distinguish between O and I_H if it didn't know there was a horizontal mirror below O? What visual properties could it use to tell them apart? Assume the eye is fixed in place.

E) If you answered that I_H is reversed left-right compared to O, how does the eye know which orientation is the correct one? Is there any way for an eye to tell the difference between an object and an image? (Again, we're restricting ourselves to just the eye. There are no hands that can reach out and feel for a solid object.)

F) Hopefully, you've concluded that, purely based on visual inspection from a fixed location, there is no way to distinguish between an object and a reflected image. With that in mind, let's treat I_H as an object rather than an image. In the diagram shown, draw several rays that locate the image of I_H in the vertical mirror (the one that's a solid line).

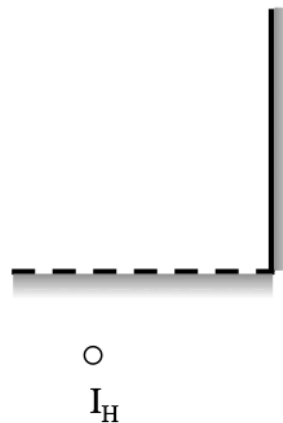

G) I_H isn't the only image here. There is also an image of O in the vertical mirror, call it I_V . In the diagram shown, draw several rays that locate the image of I_V in the horizontal mirror (the one that's a solid line).



Mirrors

Physics 104 – General Physics

H) How do the locations of the images of I_H and I_V compare?

I) Use what you now know to circle the correct orientation of the object and each image that the eye would see.

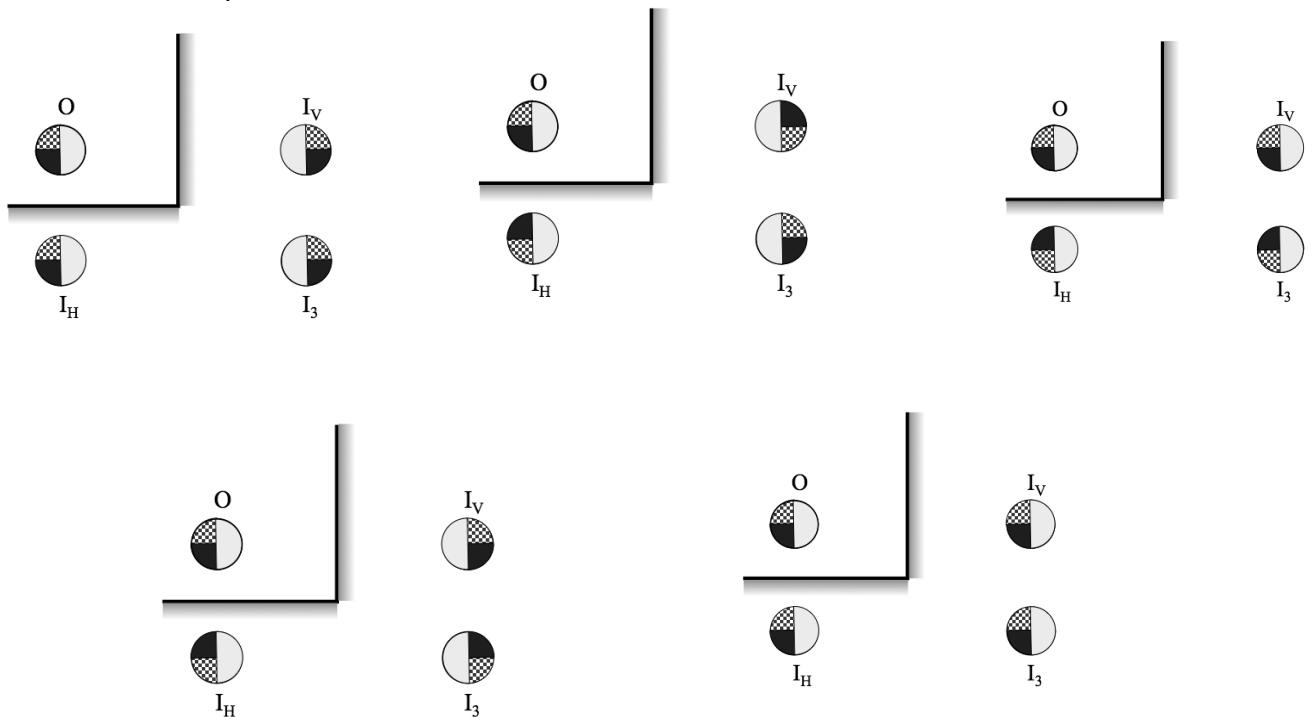

J) What is the lesson you should take away from this exercise? Select all that are true.

- When dealing with mirrors, you should ignore objects and just focus on reflected images.
- When dealing with multiple mirrors, the image in one mirror can become an object for another mirror.
- When dealing with multiple images, one will always be virtual and the other will always be real.
- When dealing with plane mirrors, it's only possible to have a single image per mirror.
- When dealing with objects and images, there is no way for eyes or mirrors to tell the difference between them.

Lenses – Group Sheet
Physics 104 – General Physics

Your group member names:

1) What does it mean when an optical component (mirror or lens) has a negative focal length? Select all that apply.

- a) Images will always be inverted.
- b) The focal point is always behind the lens.
- c) It is impossible to have a negative focal length.
- d) Light leaving the component will always be spreading out.
- e) The object will always be virtual.

2) Which of the following is true about the images produced by single optical components (that is mirrors or lenses)? Select all that apply.

- a) A real image looks 3-dimensional. A virtual image does not.
- b) A real image can be projected onto a screen. A virtual image cannot.
- c) A real image looks to be on the opposite side of the lens than the object. A virtual image appears to be on the same side as the object.
- d) Light from a real image is actually passing through the location of that image. Light from a virtual image only appears to come from the location of the image.
- e) A real image is always upright. A virtual image is always inverted.

3) A diverging lens will always produce a _____ image.

- a) Virtual, upright, smaller
- b) Real, inverted, smaller
- c) Real, inverted, larger
- d) Virtual, upright, larger
- e) Virtual, inverted, smaller

Lenses
Physics 104 – General Physics

Useful Equations:

$$\frac{1}{d_i} + \frac{1}{d_o} = \frac{1}{f} \quad m = \frac{h_i}{h_o} = -\frac{d_i}{d_o} \quad P = \frac{1}{f} \quad m_{\text{magnifier}} = \frac{25 \text{ cm}}{f}$$

Reflect on the experience you've had so far with today's topic. What sorts of notes might you want to write on a note sheet for the exam (which you can test out by using for the rest of the worksheet and on this week's homework and quiz too)?

4) When you look through a window, what are you seeing?

- a) A real image
- b) A virtual image
- c) Objects, not images

Justify your answer here:

Lenses

Physics 104 – General Physics

5) Rays that strike a converging lens near the centerline of the lens (Ray 1 in the diagram) are not bent as much as rays that strike near the end of the lens (Ray 2), where the lens is thinner.

A) Explain why this is true in your own words.

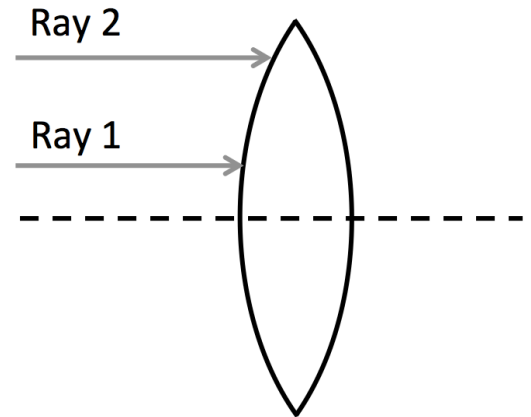

B) Use your reasoning in part A to explain why a thinner lens will have a longer focal length.

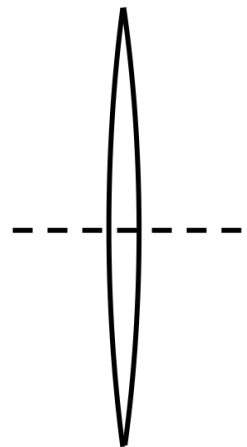

C) Rays striking the outer edge of a diverging lens (where the lens is *thicker*) will be bent more than rays striking near the centerline of the lens. Why? Does this conflict with your explanation in part A?

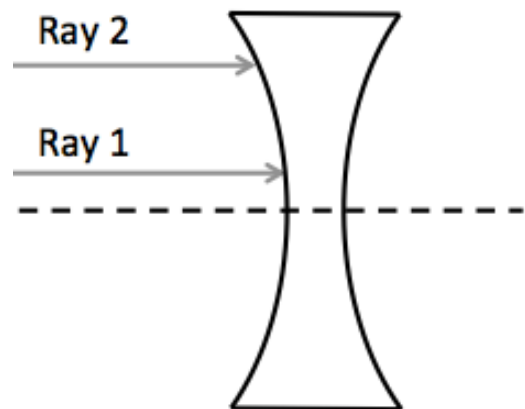

Lenses
Physics 104 – General Physics

6) A 2 cm tall object is placed 6 cm from a converging lens with a focal length of 2 cm.

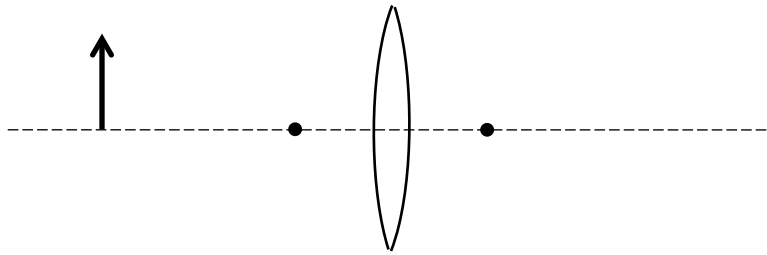

A) Calculate the image distance and magnification of the object.

B) Draw a ray diagram to locate the image using all three of the principle rays. Does this diagram confirm your calculations?

C) The image in this case is:

Upright

Inverted

Real

Virtual

Larger than the object

Smaller than the object

Lenses

Physics 104 – General Physics

D) Suppose you start to move the object away from the lens to the left. What will happen to the position of the image? (Hint: If you moved the object very, very far away, where would the image be? How would it get from the position you calculated in A to the case where the object is very, very far away?)

7) A 2 cm tall object is placed 3 cm from a converging lens with a focal length of 4 cm.

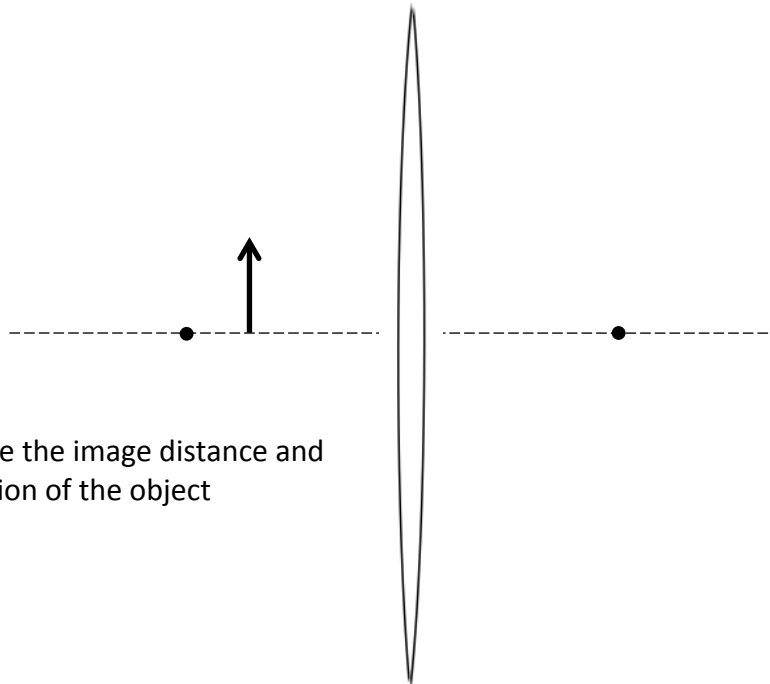

A) Calculate the image distance and magnification of the object

Lenses

Physics 104 – General Physics

B) Draw a ray diagram to locate the image using all three of the principle rays. Does this diagram confirm your calculations?

C) The image in this case is:

Upright

Inverted

Real

Virtual

Larger than the object

Smaller than the object

D) Suppose you start to move the object away from the lens to the left (but still within the focal point of the lens). What will happen to the position of the image? (Hint: If the object distance was very, very close to f , but slightly smaller, what would the image distance be? How would it get from the position you calculated in A to the case where the object is very, very close to but just inside f ?)

8) A 2 cm tall object is placed 4 cm from a diverging lens with a focal length of -6 cm.

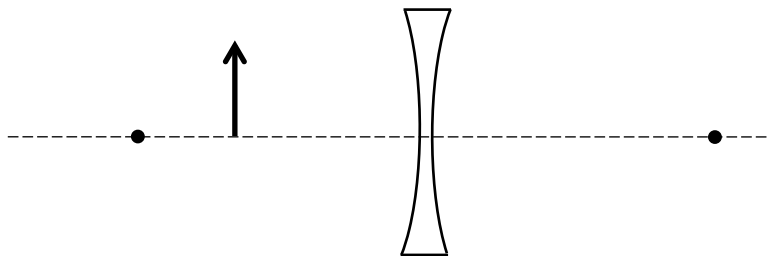

Lenses

Physics 104 – General Physics

A) Calculate the image distance and magnification of the object

B) Draw a ray diagram to locate the image using all three of the principle rays. Does this diagram confirm your calculations?

C) The image in this case is:

Upright

Inverted

Real

Virtual

Larger than the object

Smaller than the object

D) Suppose you start to move the object closer and closer to the lens. What will happen to the position of the image?

Lenses
Physics 104 – General Physics

9) When you solve the lens equation for image distance, you get $d_i = \frac{d_o f}{d_o - f}$

Use this and your answers to the questions above to complete the following table:

<p>Flat Mirror</p> <p>When an object is any distance from a flat mirror, we get a</p> <table border="1" style="display: inline-table; vertical-align: middle;"> <tr> <td style="padding: 2px;">real</td> <td style="padding: 2px;">upright</td> </tr> <tr> <td style="padding: 2px;">virtual</td> <td style="padding: 2px;">inverted</td> </tr> </table> <p>image.</p>	real	upright	virtual	inverted	<p>Flat Glass</p> <p>When an object is any distance from a flat slab of glass, we get a</p> <table border="1" style="display: inline-table; vertical-align: middle;"> <tr> <td style="padding: 2px;">real</td> <td style="padding: 2px;">upright</td> </tr> <tr> <td style="padding: 2px;">virtual</td> <td style="padding: 2px;">inverted</td> </tr> </table> <p>image.</p>	real	upright	virtual	inverted
real	upright								
virtual	inverted								
real	upright								
virtual	inverted								
<p>Concave Mirror</p> <p>When an object is between very far away and the mirror's focal length, we get a</p> <table border="1" style="display: inline-table; vertical-align: middle;"> <tr> <td style="padding: 2px;">real</td> <td style="padding: 2px;">upright</td> </tr> <tr> <td style="padding: 2px;">virtual</td> <td style="padding: 2px;">inverted</td> </tr> </table> <p>image.</p>	real	upright	virtual	inverted	<p>Converging Lens</p> <p>When an object is between very far away and the lens's focal length, we get a</p> <table border="1" style="display: inline-table; vertical-align: middle;"> <tr> <td style="padding: 2px;">real</td> <td style="padding: 2px;">upright</td> </tr> <tr> <td style="padding: 2px;">virtual</td> <td style="padding: 2px;">inverted</td> </tr> </table> <p>image.</p>	real	upright	virtual	inverted
real	upright								
virtual	inverted								
real	upright								
virtual	inverted								
<p>When an object is between the mirror's focal length and the mirror's surface, we get a</p> <table border="1" style="display: inline-table; vertical-align: middle;"> <tr> <td style="padding: 2px;">real</td> <td style="padding: 2px;">upright</td> </tr> <tr> <td style="padding: 2px;">virtual</td> <td style="padding: 2px;">inverted</td> </tr> </table> <p>image.</p>	real	upright	virtual	inverted	<p>When an object is between the lens's focal length and the lens's surface, we get a</p> <table border="1" style="display: inline-table; vertical-align: middle;"> <tr> <td style="padding: 2px;">real</td> <td style="padding: 2px;">upright</td> </tr> <tr> <td style="padding: 2px;">virtual</td> <td style="padding: 2px;">inverted</td> </tr> </table> <p>image.</p>	real	upright	virtual	inverted
real	upright								
virtual	inverted								
real	upright								
virtual	inverted								
<p>Convex Mirror</p> <p>When an object is between very far away and the mirror's focal length, we get a</p> <table border="1" style="display: inline-table; vertical-align: middle;"> <tr> <td style="padding: 2px;">real</td> <td style="padding: 2px;">upright</td> </tr> <tr> <td style="padding: 2px;">virtual</td> <td style="padding: 2px;">inverted</td> </tr> </table> <p>image.</p>	real	upright	virtual	inverted	<p>Diverging Lens</p> <p>When an object is between very far away and the lens's focal length, we get a</p> <table border="1" style="display: inline-table; vertical-align: middle;"> <tr> <td style="padding: 2px;">real</td> <td style="padding: 2px;">upright</td> </tr> <tr> <td style="padding: 2px;">virtual</td> <td style="padding: 2px;">inverted</td> </tr> </table> <p>image.</p>	real	upright	virtual	inverted
real	upright								
virtual	inverted								
real	upright								
virtual	inverted								
<p>When an object is between the mirror's focal length and the mirror's surface, we get a</p> <table border="1" style="display: inline-table; vertical-align: middle;"> <tr> <td style="padding: 2px;">real</td> <td style="padding: 2px;">upright</td> </tr> <tr> <td style="padding: 2px;">virtual</td> <td style="padding: 2px;">inverted</td> </tr> </table> <p>image.</p>	real	upright	virtual	inverted	<p>When an object is between the lens's focal length and the lens's surface, we get a</p> <table border="1" style="display: inline-table; vertical-align: middle;"> <tr> <td style="padding: 2px;">real</td> <td style="padding: 2px;">upright</td> </tr> <tr> <td style="padding: 2px;">virtual</td> <td style="padding: 2px;">inverted</td> </tr> </table> <p>image.</p>	real	upright	virtual	inverted
real	upright								
virtual	inverted								
real	upright								
virtual	inverted								

Optical Instruments – Group Sheet
Physics 104 – General Physics

Your group member names:

1) What should you do if you want to maximize the angular magnification of a magnifying glass?

- a) Look at a very large object.
- b) Use a lens with a very long focal length.
- c) Look at a very small object.
- d) Use a lens with a very large diameter.
- e) Use a lens with a very short focal length.

2) Which of the following corresponds to the location of the image formed by the objective lens in a refracting telescope and in a microscope?

	Location of the image formed by the objective in a refracting telescope	Location of the image formed by the objective in a microscope
Case A	Outside the focal length of the objective	Outside the focal length of the objective
Case B	At the focal length of the objective	At the focal length of the objective
Case C	Outside the focal length of the objective	At the focal length of the objective
Case D	At the focal length of the objective	Outside the focal length of the objective

3) An astronomical telescope has an objective lens with focal length f_o and an eyepiece with focal length f_e . A second telescope has an objective lens and eyepiece that each has double the focal length of the lenses in the first telescope. Which telescope has a greater magnification and by what factor?

- a) The first telescope has a greater magnification by 2x.
- b) The second telescope has a greater magnification by 2x.
- c) Both telescopes have the same magnification.
- d) The first telescope has a greater magnification by 4x.
- e) The second telescope has a greater magnification by 4x.

Useful Equations:

$$P = \frac{1}{f}$$

$$m_{\text{microscope}} = \frac{L}{f_0} \left(\frac{25 \text{ cm}}{f_e} \right)$$

$$m_{\text{telescope}} = \frac{f_o}{f_e}$$

$$m_{\text{angular}} = \frac{\theta_{\text{final}}}{\theta_{\text{initial}}} \sim \frac{d_{\text{initial}}}{d_{\text{final}}}$$

$$m_{\text{magnifier}} = \frac{25 \text{ cm}}{f}$$

Reflect on the experience you've had so far with today's topic. What sorts of notes might you want to write on a note sheet for the exam (which you can test out by using for the rest of the worksheet and on this week's homework and quiz too)?

4) Consider a pair of lenses.

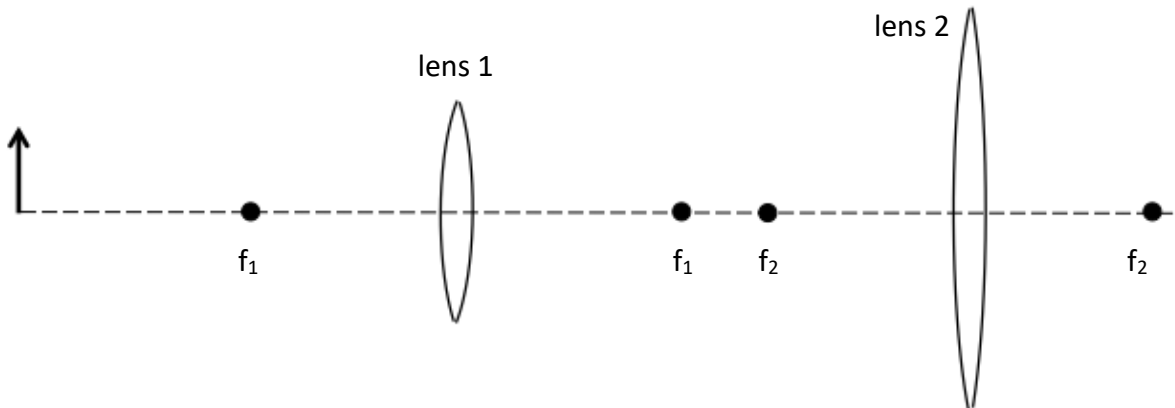

A) Assume that the object is 8 cm away from the first lens, which has a focal length f_1 of 4 cm. Calculate the position and magnification of the first image.

Optical Instruments
Physics 104 – General Physics

B) If the second lens is 10 cm away from the first lens, how far is the first image from the second lens?

C) Assume that the second lens has a focal length f_2 of 4 cm. Calculate the position and magnification of the second image.

D) Draw a ray diagram to locate the image produced by the first lens. Then draw a second ray diagram to locate the image produced by the second lens, using the image produced by the first lens as your object. Do your results agree with your calculations above?

E) Would this instrument make a good microscope? Why or why not?

F) Suppose we increase the distance between the object and the first lens. At the same time we increase the focal length of the second lens. What will happen to the position of the final image? (Assume that the image created by the first lens remains within the focal length of the second lens.)

Optical Instruments
Physics 104 – General Physics

5) We can magnify objects using a simple magnifying glass, that is, a single converging lens. What advantage is gained by adding a second lens (the objective lens) to the simple magnifier (the eyepiece) to create a compound (that is, multi-lens) microscope?

6) We determined in lecture that you want a long focal length (that is fairly weak) lens as the objective of a telescope.

A) Use the following two diagrams of lenses to show why a long-focal-length lens will create larger images of distant objects than a lens with a short focal length.

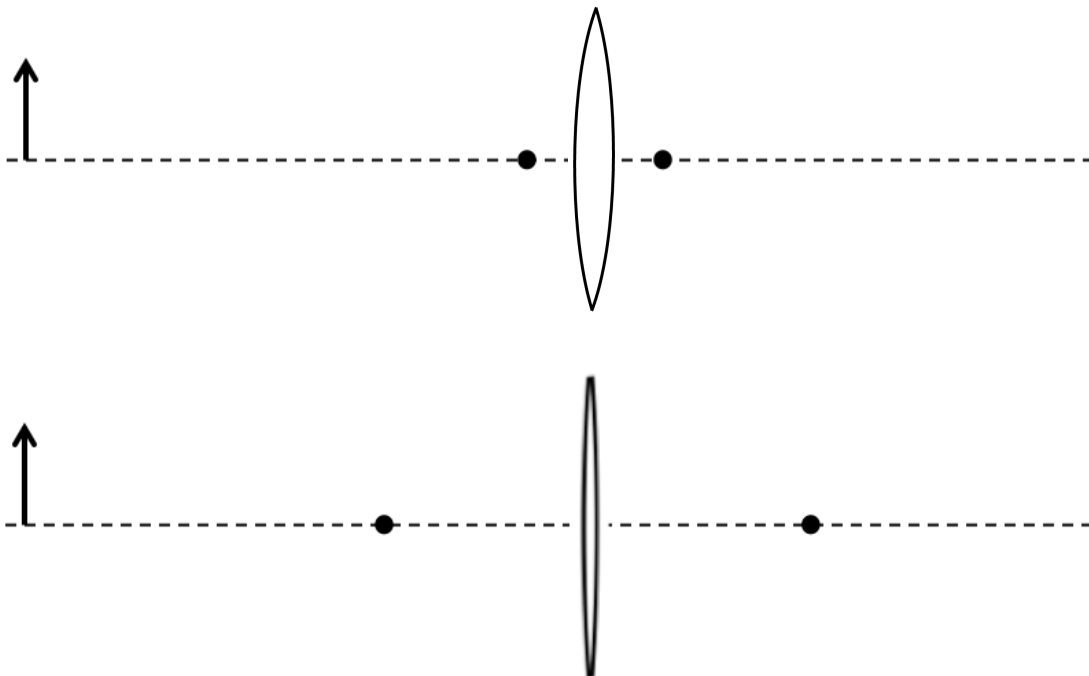

B) Explain what you've learned from these two diagrams in your own words. Is it consistent with the lens equation?

Optical Instruments
 Physics 104 – General Physics

C) How does this conclusion explain why telescopes are usually so long?

7) Can you turn a microscope into a telescope by looking through it backwards without changing its physics dimensions?

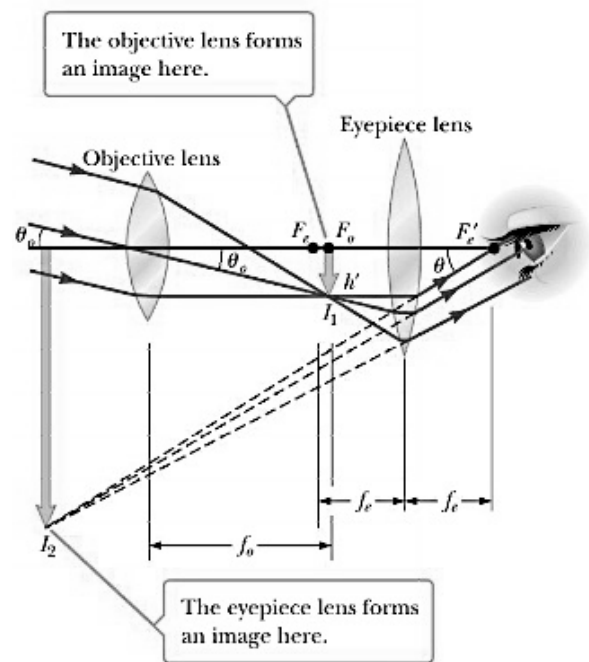
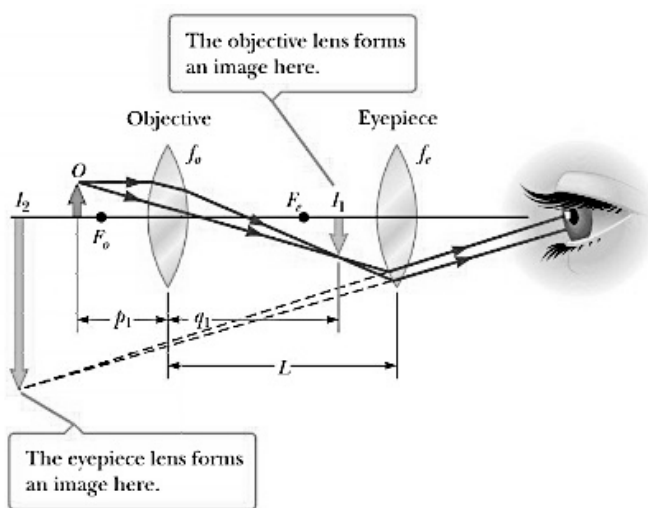

Optical Instruments
Physics 104 – General Physics

8) The first telescopes during the 1600s were composed of a converging objective lens and a diverging eyepiece. This combination produced an upright rather than an inverted image. However, to make such a telescope work, the objective lens must create an image on the *far side* of the eyepiece – that is, the object of the eyepiece is not a real object but rather a *virtual* one. In the same way that we trace rays back as if they had come from a virtual image when we draw ray diagrams, we must project rays forward as if they were heading toward a virtual object, then trace their path once they are intercepted by the lens. When doing calculations, a virtual object distance is always negative, just like a virtual image distance.

With this in mind, try calculating image distances and magnifications for the following system of lenses. You can assume the initial image distance from the objective lens is 3 cm, the focal length of the objective lens is 2 cm, the focal length of the eyepiece is -1 cm, and the distance between the two lenses is 4 cm.

Once you've finished your calculation, see if you can draw the ray diagram for this setup.

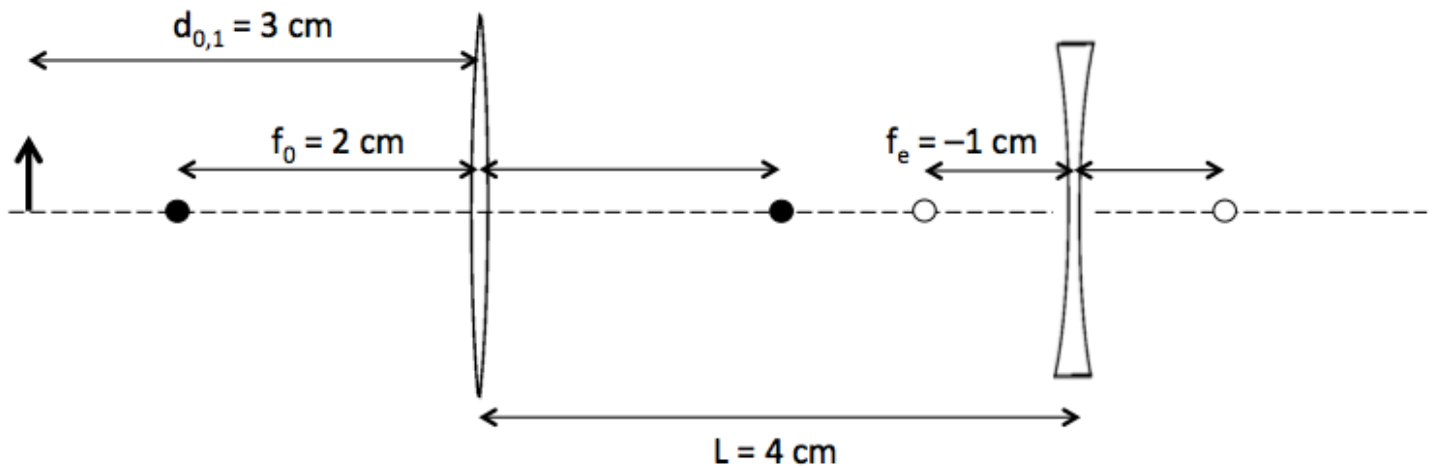

Your group member names:

1) Which of the following correctly describes the “near point” of the eyes?

- a) The focal point of the eye when fully relaxed
- b) The focal point of the eye when stretched, such as when squinting
- c) The longest distance at which a person can see clearly
- d) The shortest distance at which a person can see clearly
- e) The smallest size of a circular dot, or point, that a person can see clearly

2) The lens of the eye adjusts its power when viewing objects at different distances, in a process called accommodation. What is the power of the eye when viewing an object 50 cm away? (Assume the distance between the lens and the retina is 2.0 cm.)

- a) 2 diopters
- b) 25 diopters
- c) 50 diopters
- d) 52 diopters
- e) 100 diopters

3) An eye that is shorter than normal would result in what condition, and how could it be corrected?

- a) Far-sightedness, which could be corrected using a converging lens
- b) Near-sightedness, which could be corrected using a converging lens
- c) Far-sightedness, which could be corrected using a diverging lens
- d) Near-sightedness, which could be corrected using a diverging lens
- e) None of the above

Useful Equations:

$$P = \frac{1}{f}$$

$$\frac{1}{d_0} + \frac{1}{d_I} = \frac{1}{f}$$

$$I_{\text{final}} = I_{\text{initial}} \cos^2 \theta$$

if I_{initial} is polarized

$$I_{\text{final}} = \frac{1}{2} I_{\text{initial}}$$

if I_{initial} is unpolarized

Reflect on the experience you've had so far with today's topic. What sorts of notes might you want to write on a note sheet for the exam (which you can test out by using for the rest of the worksheet and on this week's homework and quiz too)?

4) The ray diagram below shows how light rays from a nearby object are refracted by a converging lens. Using this diagram, explain why a converging lens is used to correct far-sightedness.

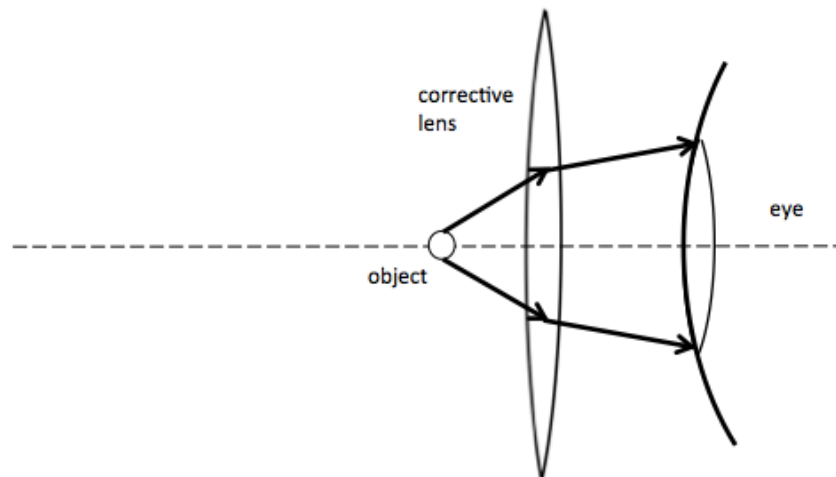

Vision

Physics 104 – General Physics

5) Now use the diagram below to explain why a diverging lens is used to correct near-sightedness. (This time, draw your own rays.):

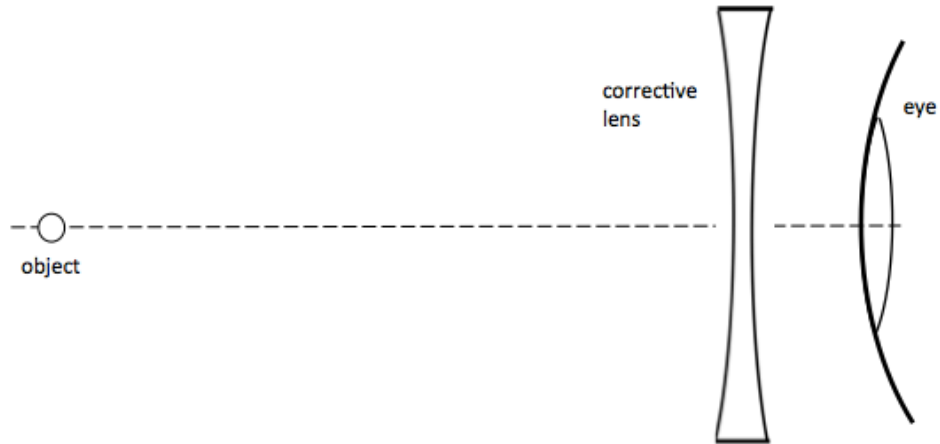

6) A person sees clearly wearing eyeglasses that have a power of -4.00 diopters when the lenses are 2.00 cm in front of the eyes.

A) What is the focal length of the lens?

B) Is the person near-sighted or far-sighted?

C) If the person wants to switch to contact lenses placed directly on the eyes, what lens power should be prescribed?

Vision

Physics 104 – General Physics

7) Suppose a farsighted person isn't able to see anything clearly closer than 45 cm. You need to prescribe a lens for a pair of glasses they can wear. The distance between the person's eye and the lens will be 2 cm.

A) If the person wants to clearly see an object with the glasses that is 20cm away, what will the object distance be for the lens?

B) How far away should the image created by the lens be away from the lens? (That is, what should be the image distance?)

C) Is this a real or virtual image?

D) What does the focal length of the lens need to be?

E) What is the power of this lens in diopters?

Vision

Physics 104 – General Physics

8) The print in many books averages 3.50 mm in height. How high is the image of the print on the retina when the book is held 30.0 cm from the eye? Assume your eyeball has a diameter of 2 cm. (It may be helpful to sketch a diagram.)

1) Which photon has more energy?

- a) a photon of ultraviolet radiation
- b) a photon of green light.
- c) a photon of yellow light
- d) a photon of red light
- e) a photon of infrared radiation

2) The color of light emitted by a hot object depends on

- a) the size of the object
- b) the shape of the object
- c) the material from which the object is made
- d) the temperature of the object
- e) the color of the object

3) Light is hitting a metal surface with photons of energy E_1 and electrons are emitted from the surface. When the energy of the photons is changed to E_2 no electrons are emitted. Which of the statements below are true? Select all that apply.

- a) E_2 is larger than E_1 .
- b) E_2 is smaller than E_1 .
- c) The work function of this metal is higher than E_2 .
- d) The work function of this metal is higher than E_1 .
- e) The work function of this metal is lower than E_2 .

4) The de Broglie wavelength depends only on

- a) the particle's mass
- b) the particle's speed
- c) the particle's energy
- d) the particle's momentum
- e) the particle's charge

Quantum Physics
Physics 104 – General Physics

Useful Equations:

$$\lambda_{\text{peak}} (\text{cm}) = \frac{(0.290 \text{ K cm})}{T} \quad \lambda_{\text{matter}} = \frac{h}{mv} \quad E_{\text{photon}} = hf = \frac{hc}{\lambda}$$

$$K_{\text{max}} = hf - \phi \quad h = 6.62 \times 10^{-34} \text{ J s} = 4.14 \times 10^{-15} \text{ eV s}$$

Reflect on the experience you've had so far with today's topic. What sorts of notes might you want to write on a note sheet for the exam (which you can test out by using for the rest of the worksheet and on this week's homework and quiz too)?

5) The temperature of the sun's surface is 5800 K.

A) Using Wien's displacement law, at what wavelength is the highest intensity?

B) What color does it correspond to? Use the graph shown (wavelength is in nm).

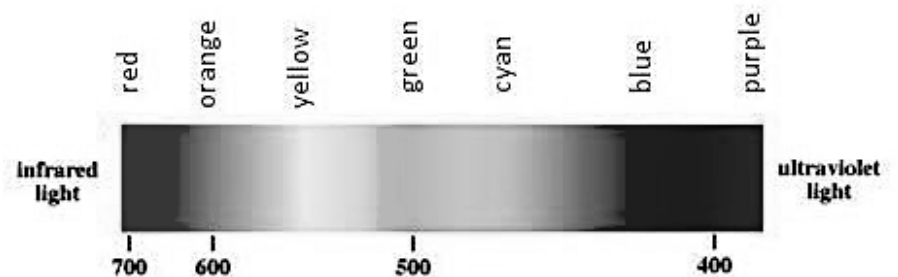

Quantum Physics
Physics 104 – General Physics

C) It is not accidental that the human eye is most sensitive to green light. Why?

D) In a distant future the sun cools down to 4000 K. At what wavelength is the maximal intensity now?

E) Which color does this wavelength correspond to?

F) Assuming humans are around in the distant future, will we still be able to see the sun with our eyes? Why or why not?

6) A beam of light with a wavelength of 62 nm is hitting the surface of an object. Electrons are emitted from this object with a maximum kinetic energy of 13.7 eV. We want to know what this object is made out of.

A) Let's break down this problem into multiple steps. What is the frequency of that light?

Metal	Work function (eV)
Al	4.08
Cu	4.70
Fe	4.50
Pt	6.35

B) What is the energy of a photon in this beam of light?

Quantum Physics
Physics 104 – General Physics

- C) Convert this energy from joule (J) to electron-volt (eV). (Remember that the charge on an electron is 1.6×10^{-19} C.)
- D) Some of this energy is used to “free” the electrons from the object (this is the work function of the material). The remaining energy of the photon becomes the kinetic energy of the emitted electron. If the kinetic energy of the emitted electron is 13.7 eV, what is the work function of the object?
- E) Using the table above, what is the object made of?
- F) What would happen if you increased the intensity of the light incident on this material but kept the wavelength the same?
- 7) In order to “see” an object, the wavelength has to be smaller than the object, which is also true for electron microscopes. If we want to see some details of a molecule we need to use electrons that have a wavelength of 0.1 nm. (The mass of an electron is 9.1×10^{-31} kg.)
- A) With what voltage do we have to accelerate the electrons?

Quantum Physics
Physics 104 – General Physics

B) If we keep the same voltage as before but use protons instead of electrons, what is the wavelength of the proton? Does the resolution improve? (The mass of a proton is 1.7×10^{-27} kg.)

C) What should you take away from this question?

- a) Electrons always have a longer wavelength than protons.
- b) If velocity is the same, heavier objects will always have shorter wavelengths.
- c) The wavelength of matter depends on what kind of microscope it's being used in.
- d) A longer wavelength means you can see smaller objects.

7) Lead sulfide is a photoconductor, which operates on a variation of the photoelectric effect. Incident light of a certain wavelength will free up electrons enough so that they can move around, which can contribute to electric current, thus reducing the overall resistance of the material. Lead sulfide in particular is often used in photodetectors because it responds well to near-infrared light.

A) You determine that when you shine light of wavelength $3.4 \mu\text{m}$ on a piece of lead sulfide, you can easily get a current flowing through it. For light with wavelengths above $3.4 \mu\text{m}$, little or no current flows. What energy (in eV) do you need to free up electrons in lead sulfide?

Quantum Physics
Physics 104 – General Physics

B) You continue to lower the wavelength of light you shine on the piece of lead sulfide. When you pass $1\ \mu\text{m}$, you notice the resistance of the material increases once again. Why do you think this might be happening?

C) If you place a plate of lead sulfide in a photoreceptor and aim a beam of light with a wavelength of $2\ \mu\text{m}$ at it, you get maximum current. If the beam has an area of $0.001\ \text{m}^2$ and an intensity of $1\ \text{W}/\text{m}^2$, how many electrons per second are you freeing up in the plate?

Your group member names:

1) A red and a green laser pointer are each rated at 2 mW.
 Which laser pointer produces more photons?

- a) The red one produces more photons.
- b) The green one produces more photons.
- c) Both produce the same number of photons

2) Which of the following transitions will emit a photon with the shortest wavelength?

- a) From $n = 4$ to $n = 3$
- b) From $n = 3$ to $n = 1$
- c) From $n = 2$ to $n = 1$
- d) From $n = 4$ to $n = 1$
- e) From $n = 3$ to $n = 2$

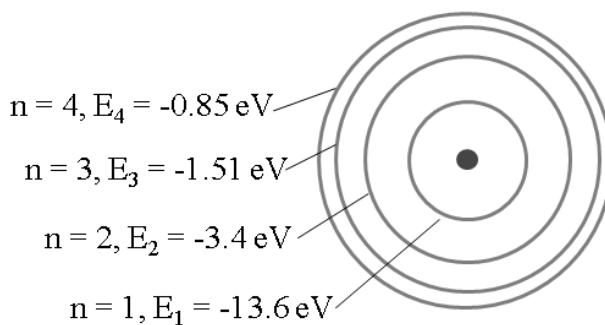

3) An electron in the ground state of a hydrogen atom requires 1.63×10^{-19} J of energy to jump to the $n = 2$ orbit. What would happen if a photon with half the required energy entered the atom?

- a) The photon would be absorbed and the electron would jump briefly to an orbit between $n = 1$ and $n = 2$.
- b) The photon would be absorbed and would raise the electron to the $n = 3$ level, which requires less energy.
- c) The photon would be absorbed and the electron would orbit the nucleus with a greater velocity.
- d) The photon would be absorbed and the electron would wait for another photon of equal energy.
- e) The photon would not be absorbed, and nothing would happen to the electron.

4) The figure shows part of the energy level diagram of a certain atom. The energy spacing between levels 1 and 2 is twice that between 2 and 3. If an electron makes a transition from level 3 to level 2, the radiation of wavelength λ is emitted. What possible radiation wavelengths might be produced by other transitions between the three energy levels?

- a) only 2λ
- b) both $\lambda/2$ and $\lambda/3$
- c) only $\lambda/2$
- d) both 2λ and 3λ

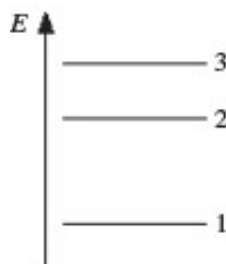

Useful Equations:

$$\frac{1}{\lambda} = R_H \left(\frac{1}{n_f^2} - \frac{1}{n_i^2} \right)$$

$$E_n = -\frac{hcR_H}{n^2}$$

$$E_{\text{photon}} = hf = \frac{hc}{\lambda}$$

$$R_H = 1.097 \times 10^7/\text{m}$$

$$hc = 1240 \text{ eV nm}$$

Reflect on the experience you've had so far with today's topic. What sorts of notes might you want to write on a note sheet for the exam (which you can test out by using for the rest of the worksheet and on this week's homework and quiz too)?

5) A carbon dioxide laser used in surgery emits infrared radiation with a wavelength of $10.6 \mu\text{m}$.

A) In 1 ms, this laser can evaporate 1 cm^3 of skin. If this action requires 2.52 kJ, how many photons from this laser were used?

B) What is the energy of the transitions in eV that electrons are falling through in the carbon dioxide atoms to create the laser light?

6) To the right is a model of an atom. Assume that there are no other energy levels in this atom than the ones shown.

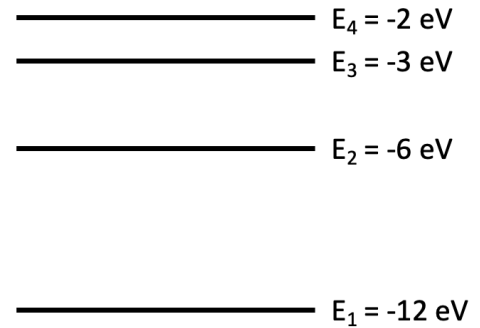

A) How many possible emission lines are there in this atom's emission spectrum?

B) Calculate the wavelength of each emission line. To identify each, use the notation $\lambda_{\text{From orbit \#, To orbit \#}}$ (for instance, λ_{41} would be the wavelength of the photon emitted as an electron fell from the $n = 4$ orbit to the $n = 1$ orbit)

C) Sketch what the emission spectrum would look like below. Short wavelengths are to the left and long wavelengths are to the right.

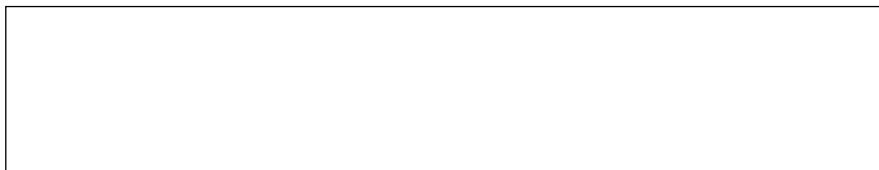

7) Suppose we have a mystery atom. We do some tests to determine that it has a ground state of -4.1 eV . We also notice that it emits three spectral lines, at 310 nm , 400 nm , and 1378 nm .

A) What is the maximum wavelength of light that will strip the atom of its electron completely?

B) What is the energy of the photons in each of the three spectral emissions?

C) Use this information to sketch a picture of the electron energy levels of this atom. Assume that the higher energy levels are closer together. Also indicate which energy level is the ground state and label the transitions that cause each of the three spectral lines.

8) A student in a physics lab observes a hydrogen emission spectrum and finds the wavelength of a yellow line to be 589 nm.

A) Assuming this is part of the Balmer Series (transitions from an initial higher level to the $n = 2$ level) determine the n of the initial level.

B) What is unreasonable about this result?

C) Where might the student have made a mistake or an unwarranted assumption?
(Don't *just* mention mis-measuring the wavelength of the spectral line.)

9) Just as in atoms, there are also energy levels in molecules. Molecular energy levels are more complicated than atomic energy levels because the molecular levels are related to a combination of the electron energy levels of their constituent atoms *and* mechanical motions of the molecules and the atoms in them. For example, a sketch of the energy levels in the molecules used in a CO₂ laser are shown below. The atoms in the CO₂ molecule can *stretch* and *bend* the bonds that attach them to the other atoms. In this type of laser a mixture of N₂ and CO₂ gas is placed in a cell. Light is brought into the cell that is absorbed by the N₂ molecules and excites them to energy levels above their ground level. The excited N₂ molecules then collide with the CO₂ molecules to excite them above their ground levels. The diagram shows some of the transitions that emit laser light. Roughly, what is the wavelength of the light emitted by a CO₂ laser? Would you be able to see it with your eyes?

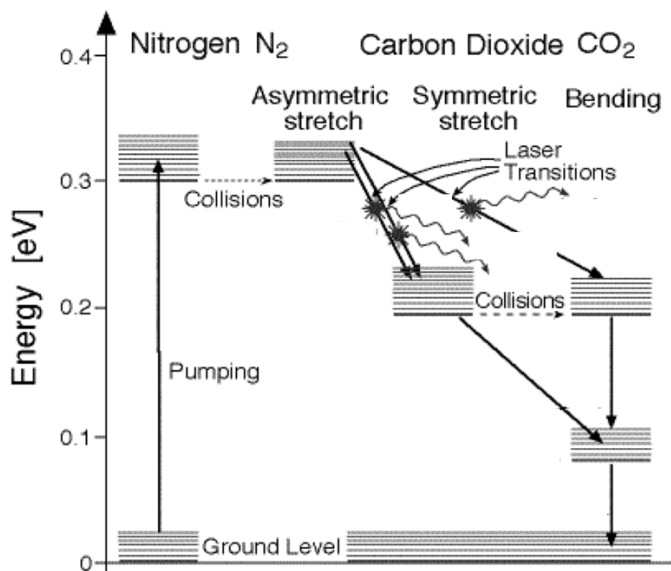

1) Which element has a nucleus with a radius of $2r_0$?

- a) Hydrogen-2 ($A = 2$)
- b) Helium-4 ($A = 4$)
- c) Beryllium-6 ($A = 6$)
- d) Boron-8 ($A = 8$)
- e) Carbon-10 ($A = 10$)

2) Why are large nuclei ($Z > 83$) typically unstable?

- a) Such nuclei begin to get too heavy so that the force of gravity puts extreme stress on them.
- b) At around 83 nucleons, the negatively charged neutrons begin to outnumber the positively charged protons.
- c) Nuclei with $Z > 83$ contain too many electrons, which forces the neutrons apart.
- d) At this size, the repulsive Coulomb force between protons is getting stronger than the attractive strong nuclear force.
- e) They binge-watched too many episodes of The Walking Dead.

3) Binding energy is....(Select all that are correct.)

- a) the energy required to break a nucleus apart.
- b) dependent on the kinetic energy of the nucleons.
- c) the energy released when individual nucleons combine to form a stable nucleus.
- d) negative
- e) only relevant for the hydrogen nucleus.

4) In massive stars, three helium nuclei fuse together, forming a carbon nucleus, and this reaction heats the core of the star. The net mass of the three helium nuclei must therefore be

- a) less than that of the carbon nucleus.
- b) the same as that of the carbon nucleus because energy is always conserved.
- c) higher than that of the carbon nucleus.
- d) the same as that of the carbon nucleus because mass is always conserved.

Nuclear Physics
Physics 104 – General Physics

Useful Equations:

$$r = r_0 A^{1/3}$$

$$|E_B| = (Nm_n + Zm_{1H} - m_{\text{atom}})c^2$$

$$m_n = 1.008665u$$

$$m_{1H} = 1.007825u$$

$$r_0 = 1.2 \text{ fm}$$

$$u = \frac{931.494}{c^2} \text{ MeV}$$

Reflect on the experience you've had so far with today's topic. What sorts of notes might you want to write on a note sheet for the exam (which you can test out by using for the rest of the worksheet and on this week's homework and quiz too)?

5) Circle the most correct free body diagrams of two protons near each other if the particles are separated by the given distances.

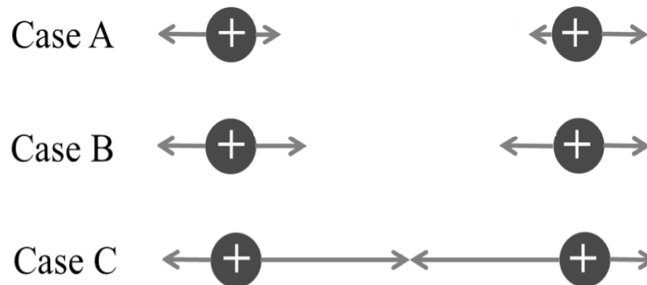

A) 12 m

Case A

Case B

Case C

B) 0.08 μm

Case A

Case B

Case C

C) 25 nm

Case A

Case B

Case C

D) 1.1 fm

Case A

Case B

Case C

6) The image to the right shows a graph of nuclides. The red line is an equal number of protons and neutrons.

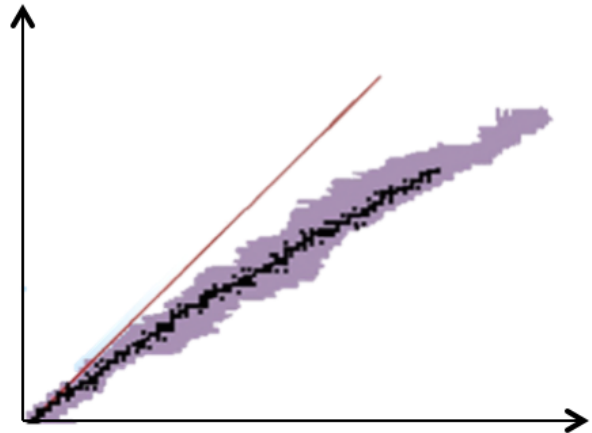

A) Indicate which axis is the number of protons in each nucleus.

B) Indicate which axis is the number of neutrons in each nucleus.

C) How did you make your choices in A and B?

D) Why aren't there nuclei on the red line as the nuclear size increases?

7) Fill out the following table:

	Atomic mass	# of Protons	# of Neutrons	Radius	Total Binding energy	Binding energy per nucleon
${}^3\text{He}$	3.01603u	2	1			
${}^4\text{He}$	4.00260u	2	2			
${}^6\text{Li}$	6.01512u	3	3			

A) Which nucleus has the largest radius?

B) Which nucleus has the greatest density?

C) Which nucleus has the greatest binding energy per nucleon?

D) Which nucleus is the most stable?

8) Below is a graph of binding energy per nucleon vs. the size of the nucleus.

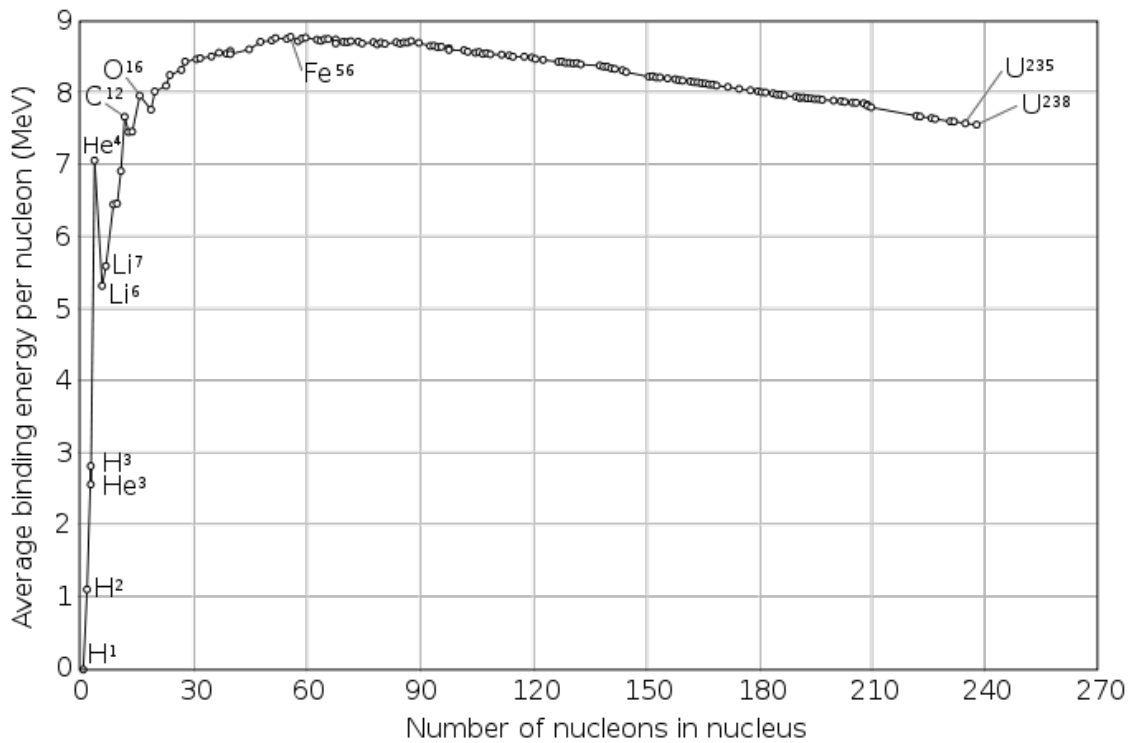

A) Which nucleus is more stable, ⁷Li or ²³⁵U?

Nuclear Physics
Physics 104 – General Physics

B) In the very early universe, shortly after the big bang, there was a short period of time when all matter was in the form of free protons and neutrons. Very quickly, a large fraction of these free nucleons formed into ${}^4\text{He}$, so much so that other elements were extremely rare. (Most of the elements around you today were formed in stars relatively recently, cosmologically speaking.) Can you explain why this happened?

C) Why do you think the vertical axis of the graph above is binding energy per nucleon. Why not just make a graph of total binding energy vs. nuclear size?

D) Assess the truth of the following statement: “It would require more energy to take apart a ${}^{235}\text{U}$ nucleus than it would to take apart a ${}^{16}\text{O}$ nucleus.”

E) Assess the truth of the following statement: “Taking 235 nucleons and forming 14 ${}^{16}\text{O}$ nuclei (plus some free nucleons) would result in a lower energy state than using those nucleons to form a single ${}^{235}\text{U}$ nucleus.”

Fission, Fusion, and Nuclear Decay – Group Sheet
Physics 104 – General Physics

Your group member names:

1) How is it possible that combining small nuclei into large nuclei can release energy?

- a) The larger nucleus must be moving slower, and so excess kinetic energy is released into the environment.
- b) The larger nucleus must have a larger binding energy, and so represent a lower overall energy state.
- c) The smaller nuclei that are fused must contain both particles and antiparticles that are annihilated when they meet.
- d) The smaller nuclei must have larger binding energies than the larger nucleus they form, which results in the release of energy.
- e) Nuclear fusion can never release energy – it consumes energy, as is the case inside the sun.
- f) Energy from fusion can be safely created from the latest line of Mr. Fusion™ brand products. Mr. Fission™ was recalled for obvious reasons.

2) Which of the following *does not* correspond to a fission process?

- a) $^{235}\text{U} \rightarrow ^{140}\text{Xe} + ^{92}\text{Sr} + 3\text{n}$
- b) $^{235}\text{U} + \text{n} \rightarrow ^{143}\text{Ba} + ^{90}\text{Kr} + 3\text{n}$
- c) $^{235}\text{U} + \text{n} \rightarrow ^{128}\text{Sb} + ^{101}\text{Nb} + 6\text{n}$
- d) $^{235}\text{U} + \text{n} \rightarrow ^{116}\text{Pd} + ^{116}\text{Pd} + 4\text{n}$

3) Which of the following would correspond to $\Delta N/\Delta t$ for a radioactive material?

- a) The number of seconds you need to wait until the entire sample had decayed
- b) The thickness of the material you would need to stop the radiation
- c) The half-life of the material
- d) The number of clicks you hear from a Geiger counter
- e) The original number of radioactive nuclei

Fission, Fusion, and Nuclear Decay
Physics 104 – General Physics

Useful Equations:

$$\frac{\Delta N}{\Delta t} = R = -\lambda N \quad N = N_0 e^{-\lambda t} \quad \tau_{1/2} = \frac{\ln 2}{\lambda}$$

Reflect on the experience you've had so far with today's topic. What sorts of notes might you want to write on a note sheet for the exam (which you can test out by using for the rest of the worksheet and on this week's homework and quiz too)?

4) Match the following types of radioactive decay with the correct statements about them. Note that more than one statement may apply to each type of decay.

Alpha Decay	<p>A proton turns into a neutron, releasing a positron (antielectron) and a neutrino.</p> <p>The number of nucleons in the nucleus (A) decreases by 4.</p> <p>The atomic number of the nucleus (Z) is increased or decreased by 1.</p>
Beta Decay	<p>The nucleus drops from an excited energy level to a lower energy level, releasing a high-energy photon.</p>
Gamma Decay	<p>The results of this decay process will not be affected if they pass through a B-field.</p> <p>A neutron turns into a proton, releasing an electron and a neutrino.</p> <p>May result in green skin.*</p>

Fission, Fusion, and Nuclear Decay
Physics 104 – General Physics

5) We have a sample of carbon that contains both Carbon-12 and Carbon-14. We'd like to know how long it will take until this sample contains 75% of the Carbon-14 it does right now. The half-life for C-14 is 5730 years.

A) In short, we want to know when N/N_0 is going to be 0.75. Before we can find a time, we need to calculate one unknown from the things we do know. Circle the one you think we need.

e

N_0

λ

$\tau_{1/2}$

B) If you circled λ , that's right (or you just looked ahead – either way, good work!). It turns out that e is a mathematical function, not a variable; we could find N_0 , but we'd need more information like the mass of the sample; and we already know $\tau_{1/2}$. So what is λ for C-14?

C) What units are λ in? Given that, what units does t in the expression $e^{-\lambda t}$ need to be in?

D) Now we need an expression for N/N_0 . Write one below.

Fission, Fusion, and Nuclear Decay
Physics 104 – General Physics

E) Just for fun, we might start by guessing that the C-14 will reduce by one-quarter (25%) in one-half of one half-life. Is this true?

F) Since our guess in E wasn't correct, solve the expression from part D for t . Note that $\ln(e^x) = x$, where \ln is the natural logarithm. (Also be aware that this equation for t is a handy thing to have maybe for an exam some day.)

G) How long from the present will the amount of C-14 have reduced to 75% of the current amount in our sample?

H) If we found a piece of wood buried in an archeological dig site and determined that 25% of the C-14 that was originally present when the wood was cut now remains, how old is our find?

6) Suppose a 5 kg cache of Strontium-90 is accidentally released in a medical facility. The atomic weight of Strontium-90 is 89.9u and the half-life is 28.8 years. We'd like to know how dangerous this situation is.

A) How many nuclei of Strontium-90 were let loose? (Note that 1 atomic mass unit, u , is equal to 1.66×10^{-27} kg.)

Fission, Fusion, and Nuclear Decay
Physics 104 – General Physics

B) What is λ for Strontium-90?

C) If you walked into the building with a Geiger counter, how many counts per second would it register?

D) Roughly speaking, exposure to 10^7 counts from Strontium-90 amounts to 1 rem. How many rem would you be exposed to if you stayed in the building for a full minute?

E) Considering that exposure to more than 500 rem over a short period results in 50% mortality, would you recommend that anyone enter?

F) If an activity (another word for $|\Delta N/\Delta t|$) of 10 counts/minute is an acceptable exposure for Strontium-90, how long will it take before the building becomes safe?

7) Suppose you start out with equal numbers of Beryllium-14 and Beryllium-11 nuclei in a sample. How long would you need to wait until the ratio of Beryllium-14 to Beryllium-11 had become 0.001? The half-life of Beryllium-14 is 4.84 s. The half-life of Beryllium-11 is 13.81 s.