

**Model 575A  
Amplifier  
Operating and Service Manual**

# **Advanced Measurement Technology, Inc.**

a/k/a/ ORTEC<sup>®</sup>, a subsidiary of AMETEK<sup>®</sup>, Inc.

## **WARRANTY**

ORTEC\* warrants that the items will be delivered free from defects in material or workmanship. ORTEC makes no other warranties, express or implied, and specifically NO WARRANTY OF MERCHANTABILITY OR FITNESS FOR A PARTICULAR PURPOSE.

ORTEC's exclusive liability is limited to repairing or replacing at ORTEC's option, items found by ORTEC to be defective in workmanship or materials within one year from the date of delivery. ORTEC's liability on any claim of any kind, including negligence, loss, or damages arising out of, connected with, or from the performance or breach thereof, or from the manufacture, sale, delivery, resale, repair, or use of any item or services covered by this agreement or purchase order, shall in no case exceed the price allocable to the item or service furnished or any part thereof that gives rise to the claim. In the event ORTEC fails to manufacture or deliver items called for in this agreement or purchase order, ORTEC's exclusive liability and buyer's exclusive remedy shall be release of the buyer from the obligation to pay the purchase price. In no event shall ORTEC be liable for special or consequential damages.

### **Quality Control**

Before being approved for shipment, each ORTEC instrument must pass a stringent set of quality control tests designed to expose any flaws in materials or workmanship. Permanent records of these tests are maintained for use in warranty repair and as a source of statistical information for design improvements.

### **Repair Service**

If it becomes necessary to return this instrument for repair, it is essential that Customer Services be contacted in advance of its return so that a Return Authorization Number can be assigned to the unit. Also, ORTEC must be informed, either in writing, by telephone [(865) 482-4411] or by facsimile transmission [(865) 483-2133], of the nature of the fault of the instrument being returned and of the model, serial, and revision ("Rev" on rear panel) numbers. Failure to do so may cause unnecessary delays in getting the unit repaired. The ORTEC standard procedure requires that instruments returned for repair pass the same quality control tests that are used for new-production instruments. Instruments that are returned should be packed so that they will withstand normal transit handling and must be shipped PREPAID via Air Parcel Post or United Parcel Service to the designated ORTEC repair center. The address label and the package should include the Return Authorization Number assigned. Instruments being returned that are damaged in transit due to inadequate packing will be repaired at the sender's expense, and it will be the sender's responsibility to make claim with the shipper. Instruments not in warranty should follow the same procedure and ORTEC will provide a quotation.

### **Damage in Transit**

Shipments should be examined immediately upon receipt for evidence of external or concealed damage. The carrier making delivery should be notified immediately of any such damage, since the carrier is normally liable for damage in shipment. Packing materials, waybills, and other such documentation should be preserved in order to establish claims. After such notification to the carrier, please notify ORTEC of the circumstances so that assistance can be provided in making damage claims and in providing replacement equipment, if necessary.

---

Copyright © 2002, Advanced Measurement Technology, Inc. All rights reserved.

\*ORTEC<sup>®</sup> is a registered trademark of Advanced Measurement Technology, Inc. All other trademarks used herein are the property of their respective owners.

## CONTENTS

WARRANTY .....	ii
SAFETY INSTRUCTIONS AND SYMBOLS .....	iv
SAFETY WARNINGS AND CLEANING INSTRUCTIONS .....	v
1. DESCRIPTION .....	1
1.1. GENERAL .....	1
1.2. POLE-ZERO CANCELLATION .....	1
1.3. ACTIVE FILTER .....	3
2. SPECIFICATIONS .....	4
2.1. PERFORMANCE .....	4
2.2. CONTROLS .....	4
2.3. INPUT .....	4
2.4. OUTPUTS .....	4
2.5. RELATED EQUIPMENT .....	4
2.6. ELECTRICAL AND MECHANICAL .....	5
3. INSTALLATION .....	5
3.1. GENERAL .....	5
3.2. CONNECTION TO POWER .....	5
3.3. CONNECTION TO PREAMPLIFIER .....	5
3.4. CONNECTION OF TEST PULSE GENERATOR .....	6
3.5. SHAPING CONSIDERATIONS .....	6
3.6. LINEAR OUTPUT CONNECTIONS AND TERMINATING CONSIDERATIONS .....	6
3.7. SHORTING OR OVERLOADING THE AMPLIFIER OUTPUT .....	7
4. OPERATION .....	7
4.1. INITIAL TESTING AND OBSERVATION OF PULSE WAVEFORMS .....	7
4.2. FRONT PANEL CONTROLS .....	7
4.3. PANEL CONNECTORS .....	7
4.4. STANDARD SETUP PROCEDURE .....	8
4.5. POLE-ZERO ADJUSTMENT .....	8
4.6. OPERATION WITH SEMICONDUCTOR DETECTORS .....	9
4.7. OPERATION IN SPECTROSCOPY SYSTEMS .....	11
4.8. OTHER EXPERIMENTS .....	13
5. MAINTENANCE .....	15
5.1. TEST EQUIPMENT REQUIRED .....	15
5.2. PULSER TEST* .....	15
5.3. SUGGESTIONS FOR TROUBLESHOOTING .....	16
5.4. FACTORY REPAIR .....	16
5.5. TABULATED TEST POINT VOLTAGES .....	16

## SAFETY INSTRUCTIONS AND SYMBOLS

This manual contains up to three levels of safety instructions that must be observed in order to avoid personal injury and/or damage to equipment or other property. These are:

**DANGER** Indicates a hazard that could result in death or serious bodily harm if the safety instruction is not observed.

**WARNING** Indicates a hazard that could result in bodily harm if the safety instruction is not observed.

**CAUTION** Indicates a hazard that could result in property damage if the safety instruction is not observed.

Please read all safety instructions carefully and make sure you understand them fully before attempting to use this product.

In addition, the following symbol may appear on the product:



**ATTENTION – Refer to Manual**



**DANGER – High Voltage**

Please read all safety instructions carefully and make sure you understand them fully before attempting to use this product.

## SAFETY WARNINGS AND CLEANING INSTRUCTIONS

**DANGER** Opening the cover of this instrument is likely to expose dangerous voltages. Disconnect the instrument from all voltage sources while it is being opened.

**WARNING** Using this instrument in a manner not specified by the manufacturer may impair the protection provided by the instrument.

### Cleaning Instructions

To clean the instrument exterior:

- Unplug the instrument from the ac power supply.
- Remove loose dust on the outside of the instrument with a lint-free cloth.
- Remove remaining dirt with a lint-free cloth dampened in a general-purpose detergent and water solution. Do not use abrasive cleaners.

**CAUTION** To prevent moisture inside of the instrument during external cleaning, use only enough liquid to dampen the cloth or applicator.

- Allow the instrument to dry completely before reconnecting it to the power source.

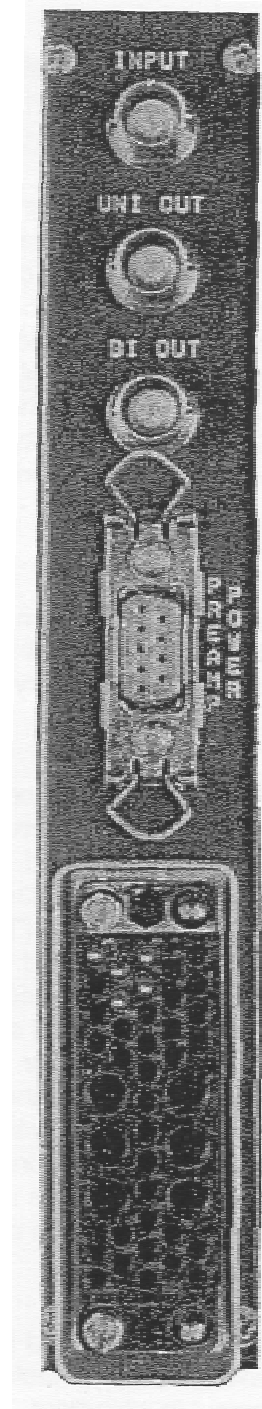
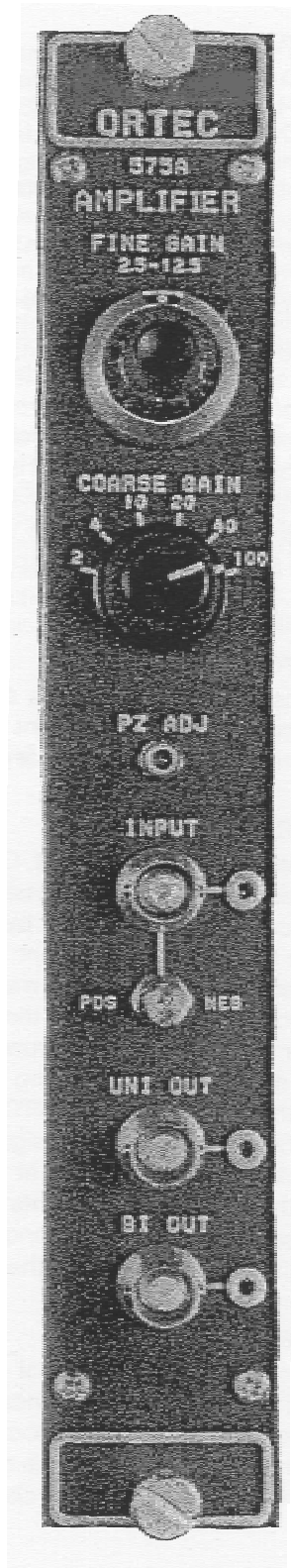

# ORTEC MODEL 575A AMPLIFIER

## 1. DESCRIPTION

### 1.1. GENERAL

The ORTEC 575A Amplifier is a single-width NIM module that features a versatile combination of jumper-selectable pulse-shaping characteristics. The amplifier has extremely low noise, a wide gain range, and excellent overload response for universal application in high-resolution spectroscopy. It accepts input pulses of either polarity. Input may originate from germanium or silicon semiconductor detectors, from scintillation counters with either fast or slow scintillators, from proportional counters, from pulsed ionization chambers, from electron multipliers, etc.

The unit has an input impedance of  $\sim 1000\Omega$  and accepts either positive or negative input pulses with rise times  $< 650$  ns and fall times  $> 30$   $\mu$ s. Three integration and differentiation time constants are jumper-selectable on the printed wiring board (PWB) to provide optimum shaping for resolution and count rate. The differentiation network has variable pole-zero cancellation that can be adjusted to match preamplifiers with decay times  $> 30$   $\mu$ s. The pole-zero cancellation drastically reduces the undershoot after the differentiator and greatly improves overload and count rate characteristics. In addition, the amplifier contains an active, filter-shaping network that optimizes the signal-to-noise ratio and minimizes the overall resolving time.

The amplifier has unipolar and bipolar BNC outputs. The unipolar output is used for spectroscopy in systems where dc coupling can be maintained from the 575A to the analyzer. A BLR (baseline restorer) circuit is included in the unit for improved performance at all count rates. Baseline correction is applied only during intervals between input pulses and automatically selects a discriminator level to identify input pulses. The unipolar output dc level is within the range of  $-5$  mV to  $+5$  mV. This output permits the use of the direct-coupled input of the analyzer with a minimum amount of interface problems.

The 575A can be used for constant-fraction timing when operated in conjunction with an ORTEC 551, 552, or 553 Timing Single-Channel Analyzer. The ORTEC Timing Single-Channel Analyzers feature a minimum of walk as a function of pulse amplitude

and incorporate a variable delay time on the output pulse to enable the timing pick-off output to be placed in time coincidence with other signals.

The 575A has complete provisions, including power distribution, for operating any ORTEC solid-state preamplifier. Normally, the preamplifier pulses should have a rise time of  $0.25$   $\mu$ s or less to properly match the amplifier filter network and a decay time  $> 30$   $\mu$ s for proper pole-zero cancellation. The input impedance is  $1000\Omega$ .

When long preamplifier cables are used, the cables can be terminated in series at the preamplifier end or in shunt at the amplifier end with the proper resistors. The output impedance is  $\sim 0.2\Omega$ , and the output can be connected to other equipment by a single cable going to all equipment. The cable must be shunt-terminated at the far end. (See Section 3 for further information).

### 1.2. POLE-ZERO CANCELLATION

Pole-zero cancellation is a method for eliminating pulse undershoot after the differentiating network. In an amplifier not using pole-zero cancellation (Fig. 1) the exponential tail on the preamplifier output signal (usually  $50$  to  $500$   $\mu$ s) causes an undershoot whose peak amplitude is roughly determined from :

$$\frac{\text{undershoot amplitude}}{\text{differentiated pulse amplitude}} \\ = \frac{\text{differentiation time}}{\text{preamplifier pulse decay time}}$$

For a  $1$ - $\mu$ s differentiation time and a  $50$ - $\mu$ s pulse decay time the maximum undershoot is  $2\%$ , and this decays with a  $50$ - $\mu$ s time constant. Under overload conditions this undershoot is often sufficiently large to saturate the amplifier during a considerable portion of the undershoot, causing excessive dead time. This effect can be reduced by increasing the preamplifier pulse decay time (which generally reduces the counting rate capabilities of the preamplifier) or compensating for the undershoot by providing pole-zero cancellation.

Pole-zero cancellation is accomplished by the network shown in Fig. 2. The pole  $[s + (1/T_0)]$  due to the preamplifier pulse decay time is cancelled by the zero of the network  $[s + (k/R_2C_1)]$ . In effect, the

dc path across the differentiation capacitor adds an attenuated replica of the preamplifier pulse to just cancel the negative undershoot of the differentiating network.

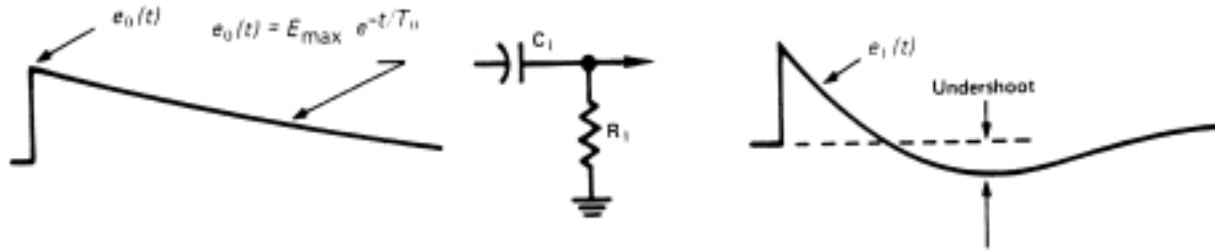

Charge loop output  $\times$  First differentiate network = Differentiated pulse with undershoot

$$E_{max} e^{-t/T_0} \times G(t) = e_1(t).$$

$$E_{max} \frac{1}{s + \frac{1}{T_0}} \times \frac{s}{s + \frac{1}{R_1 C_1}} = E_1(s) \text{ (Laplace transform).}$$

$$\frac{E_{max}}{T_0 - T_1} T_0 e^{-t/T_1} - T_1 e^{-t/T_0} = e_1(t), \text{ where } T_1 = R_1 C_1.$$

200409

Fig. 1. Differentiation in an Amplifier Without Pole-Zero Cancellation.

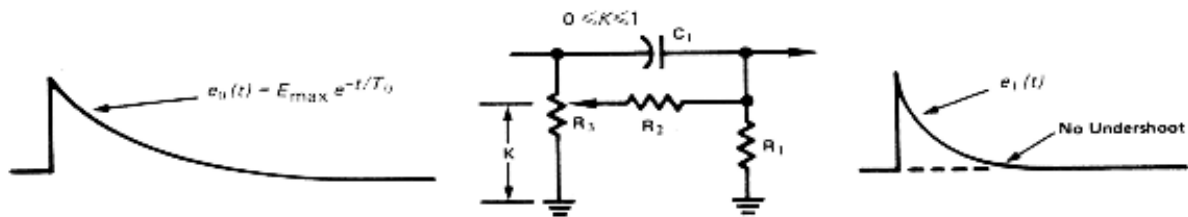

Charge loop output  $\times$  Pole-zero cancelled differentiate network = Differentiated pulse without undershoot

Pole zero cancel by letting

$$s + \frac{1}{T_0} = s + \frac{K}{R_2 C_1}.$$

or

$$\frac{E_{max}}{s + \frac{1}{R_1 + R_2}} = \frac{E_{max}}{s + \frac{1}{R_p C_1}} = E_1(s), \text{ where } R_p = \frac{R_1 R_2}{R_1 + R_2}$$

$$E_{max} \frac{1}{s + \frac{1}{T_0}} \times \frac{s + \frac{K}{R_2 C_1}}{s + \frac{1}{R_1 + R_2}} = E_1(s) \text{ (Laplace transform).}$$

$$E_{max} e^{-t/R_p C_1} = e_1(t).$$

200410

Fig. 2. Differentiation in a Pole-Zero Cancelled Amplifier.



Total preamplifier-amplifier pole-zero cancellation requires that the preamplifier output pulse decay time be a single exponential decay and be matched to the pole-zero cancellation network. The variable pole-zero cancellation network allows accurate cancellation for all preamplifiers having 30- $\mu$ s or greater decay times. Improper matching of the pole-zero network will degrade the overload performance and cause excessive pileup distortion at medium counting rates. Improper matching causes either an undercompensation (undershoot is not eliminated) or an overcompensation (output after the main pulse does not return to the baseline but decays to the baseline with the preamplifier time constant). The pole-zero adjust is accessible on the front panel of the 575A and can easily be adjusted by observing the baseline on an oscilloscope with a monoenergetic source or pulser having the same decay time as the preamplifier under overload conditions. The adjustment should be made so that the pulse returns to the baseline in the minimum time with no undershoot.

### 1.3. ACTIVE FILTER

When only FET gate current and drain thermal noise are considered, the best signal-to-noise ratio occurs when the two noise contributions are equal for a given input pulse shape. The Gaussian pulse shape (Fig. 3) for this condition requires an amplifier with a single RC differentiation and  $n$  equal RC integrations where  $n$  approaches infinity. The Laplace transform of this transfer function is

$$G(s) = \frac{s}{s + (1/RC)} \times \frac{1}{[s + (1/RC)]^n} \quad (n \rightarrow \infty),$$

where the first factor is the single differentiation, and the second factor is the  $n$  integrations. The active filter approximates this transfer function.

Figure 3 illustrates the results of pulse shaping in an amplifier. Of the four pulse shapes shown the cusp would produce minimum noise, but this is impractical to achieve with normal electronic circuitry and would be difficult to measure with an ADC. The true Gaussian shape deteriorates the signal-to-noise ratio by only about 12% from that of the cusp and produces a signal that is easy to measure but requires many sections of integration ( $n \rightarrow \infty$ ). With two sections of integration the waveform identified as a Gaussian approximation can be obtained, and this deteriorates the signal-to-noise ratio by about 22%. The ORTEC active filter network in the 575A provides a fourth waveform in

Fig. 3; this waveform has characteristics superior to the  $n = 2$  Gaussian approximation, yet obtains them with two complex poles and a real pole. By this method, the output pulse shape has a good signal-to-noise ratio, is easy to measure, and yet requires only a practical amount of electronic circuitry to achieve the desired results.

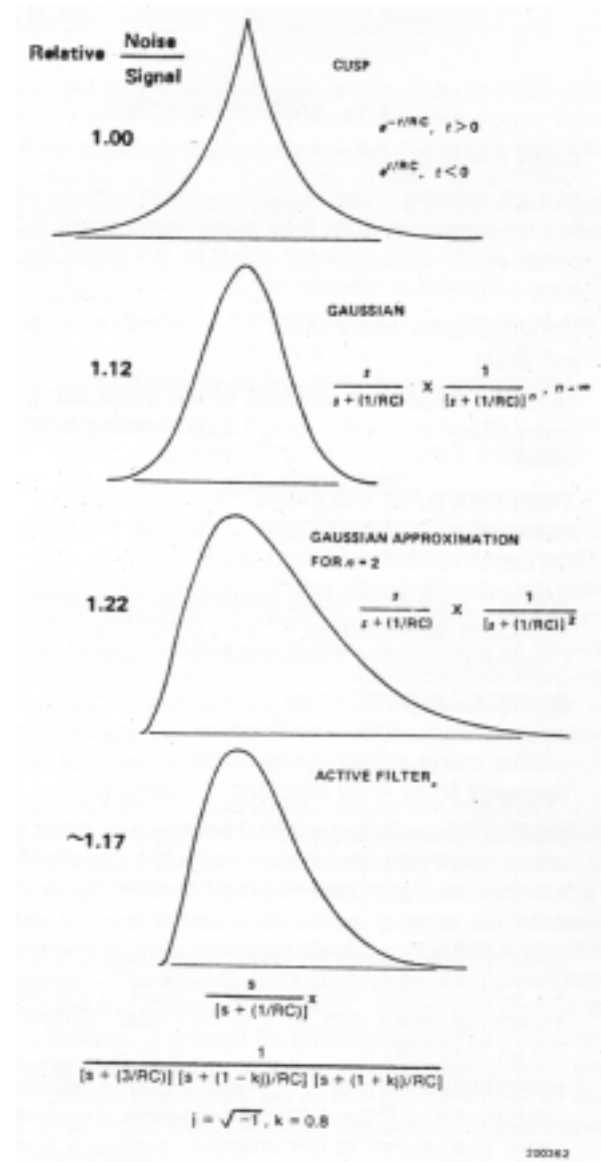

Fig. 3. Pulse Shapes for Good Signal-to-Noise Ratios.

## 2. SPECIFICATIONS

### 2.1. PERFORMANCE

**GAIN RANGE** Continuously adjustable from 5 to 1250.

**PULSE SHAPE** Semi-Gaussian on all ranges with peaking time equal to  $2.2T$ , 50% pulse width equal to  $3.3T$ , and pulse width at 0.1% level equal to 4.0 times the peaking time. Bipolar crossover =  $1.5T$ .

**INTEGRAL NONLINEARITY**  $\leq \pm 0.05\%$  for 1.5- $\mu$ s shaping time.

**NOISE**  $< 5 \mu$ V rms referred to the input using 3  $\mu$ s unipolar shaping;  $< 7 \mu$ V using 1.5  $\mu$ s shaping; both for a gain  $\geq 100$ .

#### TEMPERATURE INSTABILITY

**Gain**  $\leq \pm 0.0075\%/^{\circ}\text{C}$ , 0 to  $50^{\circ}\text{C}$ .

**Dc Level**  $\leq \pm 30 \mu\text{V}/^{\circ}\text{C}$ , 0 to  $50^{\circ}\text{C}$ .

**WALK**  $\leq \pm 5$  ns at 0.5  $\mu$ s shaping for 50:1 dynamic range, including contribution of an ORTEC 551 or 552 Constant-Fraction Timing Single-Channel Analyzer.

**OVERLOAD RECOVERY** Recovers to within 2% of rated output from  $\times 300$  overload in 2.5 nonoverload pulse widths using maximum gain for unipolar output. Same recovery from  $\times 500$  overload for bipolar.

**RESTORER** Gated active baseline stabilizer with automatic threshold circuit to provide the threshold level as a function of signal noise to the baseline restorer discriminator.

**SPECTRUM BROADENING\*** Typically  $< 10\%$  FWHM for a  $^{60}\text{Co}$  1.33-MeV gamma line at 85% of full scale for an incoming count rate of 1 to 50k cps. Unipolar output, 1.5  $\mu$ s shaping.

**SPECTRUM SHIFT\*** Peak position shifts typically  $< 0.02\%$  for a  $^{60}\text{Co}$  1.33-MeV gamma line at 85% of full scale (measured at the unipolar output, 1.5  $\mu$ s shaping, 1 to 50k cps).

\*These count rate specifications were measured with a 10% HPGe detector. Detectors with a large number of slow, rise-time signals will most likely give poorer results.

### 2.2. CONTROLS

**FINE GAIN** Ten-turn precision potentiometer with graduated dial for continuously variable direct-reading gain factor of  $\times 2.5$  to  $\times 12.5$ .

**COARSE GAIN** Six-position switch selects feedback resistors for gain factors of 2, 4, 10, 20, 40, and 100.

**SHAPING TIME** Three-position printed wiring board (PWB) jumpers, easily accessible through side panel, select time constants for active pulse-shaping filter network of 0.5, 1.5, or 3  $\mu$ s.

**POS/NEG** Toggle switch selects either Pos or Neg input pulse polarity.

**PZ ADJ** Screwdriver adjustable potentiometer to set the pole-zero cancellation to compensate input decay times from 30  $\mu$ s to  $\infty$ .

### 2.3. INPUT

**INPUT** BNC (UG-1094A/U) front and rear panel connectors accept either positive or negative pulses with rise times of 10 to 650 ns and decay times of 30  $\mu$ s to  $\infty$ ;  $Z_{in} = 1000\Omega$  dc-coupled; linear maximum 2 V; absolute maximum 20 V.

### 2.4. OUTPUTS

**UNI** Front panel BNC connector with  $Z_o < 1\Omega$  and rear panel connector with  $Z_o = 93\Omega$ . Short-circuit proof; full-scale linear range of 0 to +10 V; active filter shaped; dc-restored with dc level adjustable to  $\pm 25\text{mV}$ .

**BI** Front panel BNC connector with  $Z_o < 1\Omega$  and rear panel connector with  $Z_o = 93\Omega$ . Short-circuit proof; positive lobe leading and full-scale linear range of 0 to +10 V; active filter shaped.

**PREAMP POWER** Rear panel standard ORTEC power connector (Amphenol 17-10090) mates with captive and noncaptive power cords on all ORTEC preamplifiers.

### 2.5. RELATED EQUIPMENT

The ORTEC 575A Amplifier accepts linear pulses from, and furnishes power to, any standard ORTEC preamplifier or equivalent. Its output pulses may be used for linear signal analysis, using any of the

ORTEC modular instruments and multichannel analyzers.

## 2.6. ELECTRICAL AND MECHANICAL

**POWER REQUIRED** +24 V, 55 mA; -24 V, 40 mA; +12 V, 70 mA; -12 V, 75 mA.

## WEIGHT

**Net** 1.5 kg (3.3 lb).

**Shipping** 3.1 kg (7.0 lb.)

**DIMENSIONS** Standard single-width NIM module 3.43 × 22.13 cm (1.35 × 8.714 in.) per TID-20893 (Rev).

## 3. INSTALLATION

### 3.1. GENERAL

The 575A operates on power that must be furnished from a NIM-standard bin and power supply such as the ORTEC 4001A/4002A Series. The bin and power supply is designed for relay rack mounting. If the equipment is to be rack mounted, be sure that there is adequate ventilation to prevent any localized heating of the components used in the 575A. The temperature of equipment mounted in racks can easily exceed the maximum limit of 50°C unless precautions are taken.

### 3.2. CONNECTION TO POWER

The 575A contains no internal power supply and must obtain the necessary dc operating power from the bin and power supply in which it is installed for operation. Always turn off power for the power supply before inserting or removing any modules. After all modules have been installed in the bin and any preamplifiers have also been connected to the Preamp Power connectors on the amplifiers, check the dc voltage levels from the power supply to see that they are not overloaded. The ORTEC 4001A/4002A Series Bins and Power Supplies have convenient test points on the power supply control panel to permit monitoring these dc levels. If any one or more of the dc levels indicates an overload, some of the modules will need to be moved to another bin to achieve operation.

### 3.3. CONNECTION TO PREAMPLIFIER

The preamplifier output signal is connected to the 575A through the Input BNC connectors on the front and rear panels. The input impedance is  $\sim 1000\Omega$  and is dc-coupled to ground; therefore, the preamplifier output must be either ac-coupled or have approximately zero dc voltage under no-signal conditions.

The 575A incorporates pole-zero cancellation to enhance the overload and count rate characteristics of the amplifier. This technique requires matching the network to the preamplifier decay-time constant to achieve perfect compensation. The pole-zero adjustment should be set each time the preamplifier or the shaping time constant of the amplifier is changed. For details of the pole-zero adjustment see Section 4.5. An alternate method is accomplished easily by using a monoenergetic source and observing the amplifier baseline with an oscilloscope after each pulse under  $\sim 2$  overload conditions. Adjustment should be made so that the pulse returns to the baseline in a minimum amount of time with no undershoot.

Preamplifier power at +24 V, -24 V, +12 V, and -12 V is available through the Preamp Power connector on the rear panel. When the preamplifier is connected, its power requirements are obtained from the same bin and power supply as is used for the amplifier, and this increases the dc loading on each voltage level over and above the requirements for the unit at the module position in the bin.

When the 575A is used with a remotely located preamplifier (i.e., preamplifier-to-amplifier connection through 25 ft or more of coaxial cable), be careful to ensure that the characteristic impedance of the transmission line from the preamplifier output to the 575A input is matched. Because the input impedance of the 575A is  $\sim 1000\Omega$ , sending-end termination will normally be preferred; the transmission line should be series-terminated at the preamplifier output. All ORTEC preamplifiers contain series terminations that are either  $93\Omega$  or variable; coaxial cable type RG-62/U or RG-71/U is recommended.

### 3.4. CONNECTION OF TEST PULSE GENERATOR

**THROUGH A PREAMPLIFIER** The satisfactory connection of a test pulse generator (such as the ORTEC 419 Precision Pulse Generator or equivalent) depends primarily on two considerations: the preamplifier must be properly connected to the unit as discussed in Section 3.3, and the proper input signal simulation must be applied to the preamplifier. To ensure proper input signal simulation, refer to the instruction manual for the particular preamplifier being used.

**DIRECTLY INTO THE 575A** Since the input of the 575A has 1000- $\Omega$  input impedance, the test pulse generator will normally have to be terminated at the amplifier input with an additional shunt resistor. In addition, if the test pulse generator has a dc offset, a large series isolating capacitor is also required because the 575A input is dc coupled. The ORTEC test pulse generators are designed for direct connection. When any one of these units is used, it should be terminated with a 100- $\Omega$  terminator at the amplifier input or be used with at least one of the output attenuators set at In. (The small error due to the finite input impedance of the amplifier can normally be neglected.)

**SPECIAL CONSIDERATIONS FOR POLE-ZERO CANCELLATION** When a tail pulser is connected directly to the amplifier input, the PZ ADJ should be adjusted if overload tests are to be made (other tests are not affected). See Section 4.5 for the pole-zero adjustment. If a preamplifier is used and a tail pulser is connected to the preamplifier test input, similar precautions are necessary. In this case the effect of the pulser decay must be removed; that is, a step input should be simulated.

### 3.5. SHAPING CONSIDERATIONS

The shaping time constant on the 575A is selectable by PWB-mounted jumpers in steps of 0.5, 1.5, and 3  $\mu$ s. The choice of the proper shaping time constant is generally a compromise between operating at a shorter time constant for accommodation of high counting rates and operating with a longer time constant for a better signal-to-noise ratio. For scintillation counters, the energy resolution depends largely on the scintillator and photomultiplier, and therefore a shaping time constant of about four times the decay-time constant of the scintillator is a reasonable choice (for NaI, a 1.5- $\mu$ s shaping time constant is about optimum). For gas proportional counters, the

collection time is normally in the 0.5 to 5  $\mu$ s range and a 1.5  $\mu$ s or greater time constant selection will generally give optimum resolution. For surface barrier semiconductor detectors, a 0.5- to 2- $\mu$ s resolving time will generally provide optimum resolution. Shaping time for Ge(Li) detectors will vary from 1.5 to 6  $\mu$ s, depending on the size, configuration, and collection time of the specific detector and preamplifier. When a charge-sensitive preamplifier is used, the optimum shaping time constant to minimize the noise of a system can be determined by measuring the output noise of the system and dividing it by the system gain. The 575A has almost constant gain for all shaping modes; therefore, the optimum shaping can be determined by measuring the output noise with a voltmeter as each shaping time constant is selected.

### 3.6. LINEAR OUTPUT CONNECTIONS AND TERMINATING CONSIDERATIONS

Since the 575A unipolar output is normally used for spectroscopy, the unit is designed with the flexibility to interface the pulse with an analyzer. A gated baseline restorer (BLR) circuit is included in this output for improved performance at all count rates. The threshold for the restorer gate is determined automatically, according to the input noise level. The unipolar output dc level is 0 to  $\pm$  5 mV. Three general methods of termination are used. The simplest of these is shunt termination at the receiving end of the cable. A second method is series termination at the sending end. The third is a combination of series and shunt termination, where the cable impedance is matched both in series at the sending end and in shunt at the receiving end. The combination is most effective, but this reduces the amount of signal strength at the receiving end to 50% of that which is available in the sending instrument.

To use shunt termination at the receiving end of the cable, connect the output from the 575A front or rear panels through 93- $\Omega$  cable to the input of the receiving instrument. Then use a BNC tee connector to attach both the interconnecting cable and a 100- $\Omega$  terminator at the input connector of the receiving instrument. Since the input impedance of the receiving instrument is normally 1000 $\Omega$  or more, the effective instrument input impedance with the 100- $\Omega$  terminator will be of the order of 93 $\Omega$ , and this will match the cable impedance correctly.

For customer convenience, ORTEC stocks the proper terminators and BNC tees, or they can be ordered from a variety of commercial sources.

### 3.7. SHORTING OR OVERLOADING THE AMPLIFIER OUTPUT

The 575A output is dc-coupled with an output impedance of  $\sim 0.2\Omega$ . If the output is shorted with a direct short circuit, the output stage will limit the peak current of the output so that the amplifier will

not be harmed. When the amplifier is terminated with  $100\Omega$ , the maximum count rate consistent with linear output is

$$Rate_{\max} = \frac{125\,000\text{ cps}}{\tau} \times \frac{10}{V_o}$$

where  $V_o$  is the peak output pulse amplitude in volts (V) and  $\tau$  is the shaping time in  $\mu\text{s}$ .

## 4. OPERATION

### 4.1. INITIAL TESTING AND OBSERVATION OF PULSE WAVEFORMS

Refer to Section 5 for information on testing performance and observing waveforms at front panel test points. Figure 4 shows typical output waveforms.

### 4.2. FRONT PANEL CONTROLS

**GAIN** A Coarse Gain switch and a Gain control (a precision 10-turn locking potentiometer) select and precisely adjust the gain factor for the amplification in the 575A. Switch settings are  $\times 2$ , 4, 10, 20, 40, and 100. Continuous fine gain range is from  $\times 0.5$  to  $\times 12.5$  using markings of 500 through 1250 dial divisions.

Using these controls collectively, the gain can be set at any level from  $\times 5$  through  $\times 1250$ .

**POS/NEG** A toggle switch selects an input circuit which accepts either polarity of pulses from the preamplifier.

**PZ ADJ** A screwdriver control sets the pole-zero cancellation to match the preamplifier pulse decay characteristics. The range is from  $30\ \mu\text{s}$  to  $\infty$ .

**SHAPING** PWB jumpers, easily accessed through the side panel, select equal integration and differentiation time constants to shape the input pulses. Settings are  $0.5$ ,  $1.5$ , and  $3\ \mu\text{s}$ . Illustrated drawings and instructions for setting time-constant jumpers are shown in Fig. 5.

### 4.3. PANEL CONNECTORS

**INPUTS** Accept input pulses to be shaped and/or amplified by the 575A. Compatible characteristics; positive or negative with rise time from 10 to 650 ns; decay time  $>30\ \mu\text{s}$  for proper pole-zero

cancellation; input linear amplitude range 0 to 2 V with a maximum limit of  $\pm 20\ \text{V}$ . Input impedance is  $\sim 1000\Omega$ .

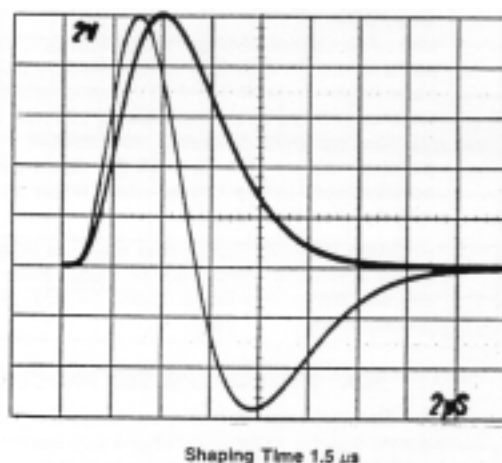

Fig. 4. Typical Unipolar and Bipolar Output Waveforms.

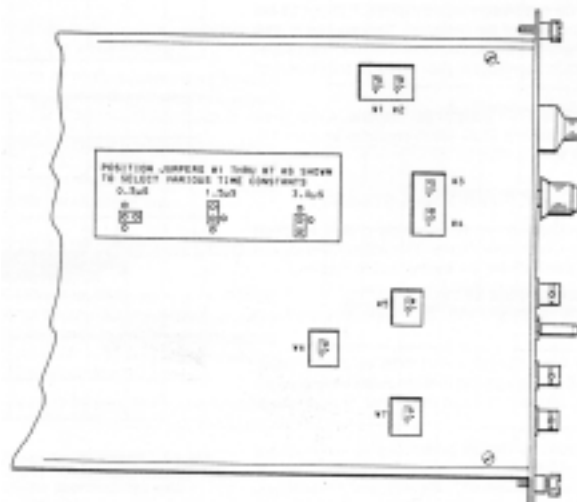

Fig. 5. Settings for Time-Constant Jumpers.

## OUTPUTS

**UNI** Front panel BNC connector with  $Z_o < 1\Omega$  and rear panel connector with  $Z_o = 93\Omega$ . Short-circuit proof; full-scale linear range of 0 to +10 V; active filter shaped; dc-restored with dc level adjustable to  $\pm 25$  mV.

**BI** Front panel BNC connector with  $Z_o < 1\Omega$  and rear panel connector with  $Z_o = 93\Omega$ . Short-circuit proof; positive lobe leading and full-scale linear range of 0 to +10 V; active filter shaped.

**PREAMP POWER** Rear panel standard ORTEC power connector (Amphenol 17-10090) mates with captive and noncaptive power cords on all ORTEC preamplifiers.

### 4.4. STANDARD SETUP PROCEDURE

- Connect the detector, preamplifier, high-voltage power supply, and preamplifier into a basic system and connect the amplifier output to an oscilloscope. Connect the preamplifier power cable to the Preamp connector on the 575A rear panel. Turn on power in the bin and power supply and allow the electronics of the system to warm up and stabilize.
- Set the 575A controls initially as follows:

Shaping	1.5 $\mu$ s
Coarse Gain	10
Fine Gain	5.00
Pos/Neg	Match input pulse polarity

- Use a  $^{60}\text{Co}$  calibration source; place it about 25 cm from the active face of the detector. The unipolar output pulse from the 575A should be about 8 to 10 V using a preamplifier with a conversion gain (charge sensitivity) of 170 mV/MeV.
- Readjust the Gain control so that the higher peak from the  $^{60}\text{Co}$  source (1.33 MeV) provides an amplifier output at  $\sim 9$  V.

### 4.5. POLE-ZERO ADJUSTMENT

The pole-zero adjustment is extremely critical for good performance at high count rates. This adjustment should be checked carefully for the best possible results.

### USING A GERMANIUM SYSTEM AND $^{60}\text{Co}$

- Adjust the radiation source count rate between 2 kHz and 10 kHz.

- Observe the unipolar output with an oscilloscope. Adjust the PZ ADJ control so that the pulse trailing edges return to the baseline without overshoot or undershoot (Fig. 6).

The oscilloscope used must be dc coupled and must not contribute distortion in the observed waveforms. Oscilloscopes such as Tektronix 453, 454, 465, and 475 will overload for a 10-V signal when the vertical sensitivity is  $< 100$  mV/cm. To prevent overloading the oscilloscope, use the clamp circuit shown in Fig. 7.

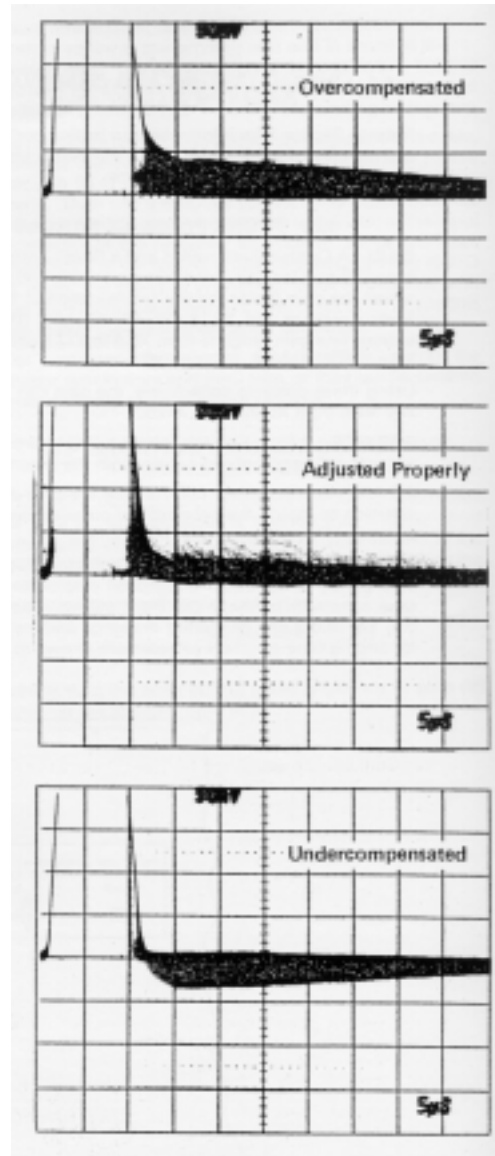

Fig. 6. Typical Waveforms Illustrating Pole-Zero Adjustment Effects; Oscilloscope Trigger, Internal Pos.,  $^{60}\text{Co}$  Source with 1.33-MeV Peak Adjusted  $\sim 9$  V; Count Rate 3 kHz; Shaping Time Constant 1.5  $\mu$ s.

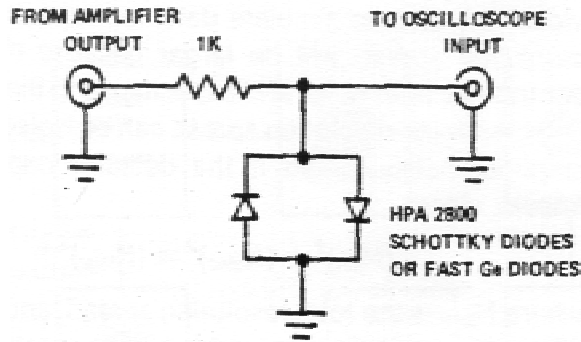

Fig. 7. A Clamp Circuit that can be used to Prevent Overloading the Oscilloscope Input.

### USING SQUARE WAVE THROUGH PREAMPLIFIER TEST INPUT

A more precise pole-zero adjustment in the 575A can be obtained by using a square wave signal as the input to the preamplifier. Many oscilloscopes include a calibration output on the front panel, and this is a good source of square wave signals at a frequency of  $\sim 1$  kHz. The amplifier differentiates the signal from the preamplifier so that it generates output signals of alternate polarities on the leading and trailing edges of the square wave input signal, and these can be compared as shown in Fig. 8 to achieve excellent pole-zero cancellation. Use the following procedure:

- Remove all radioactive sources from the vicinity of the detector. Set up the system as for normal operation, including detector bias.
- Set the 575A controls as for normal operation; this includes gain, shaping, and input polarity.
- Connect the source of 1-kHz square waves through an attenuator to the Test input of the preamplifier. Adjust the attenuator so that the 575A output amplitude is  $\sim 9$  V.
- Observe the Unipolar output of the 575A with an oscilloscope. Adjust the PZ ADJ control for proper response according to Fig. 8. Use the clamp circuit in Fig. 7. to prevent overloading the oscilloscope input.

### 4.6. OPERATION WITH SEMICONDUCTOR DETECTORS

**CALIBRATION OF TEST PULSER** An ORTEC 419 Precision Pulse Generator (or equivalent) is easily calibrated so that the maximum pulse height dial reading (1000 divisions) is equivalent to 10-MeV loss in a silicon radiation detector. The procedure is as follows:

- Connect the detector to be used to the spectrometer system; that is, preamplifier, main amplifier, and biased amplifier.
- Allow excitation from a source of known energy (e.g., alpha particles) to fall on the detector.

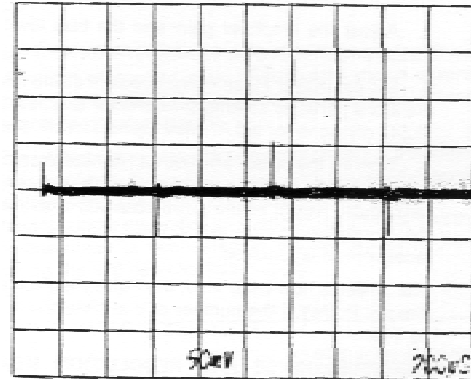

A. PZ Properly Adjusted; Slow Trigger to Separate Pulses.

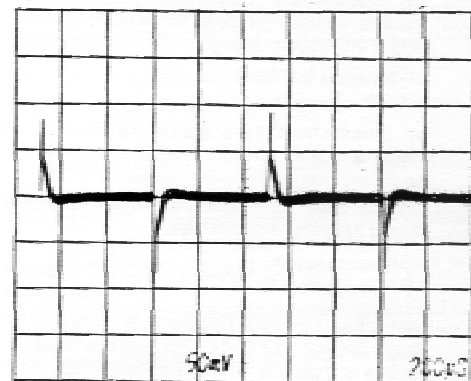

B. Overcompensated.

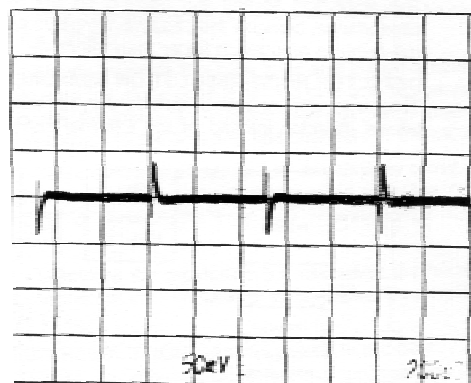

C. Undercompensated.

Fig. 8. Pole-Zero Adjustment Using a Square W to the Preamplifier.

- Adjust the amplifier gain and the bias level of the biased amplifier to give a suitable output pulse.

- d. Set the pulser Pulse Height control at the energy of the alpha particles striking the detector (e.g., set the dial at 547 divisions for a 5.47-MeV alpha particle energy).
- e. Turn on the pulser and use its Normalize control and attenuators to set the output due to the pulser for the same pulse height as the pulse obtained in step c. Lock the Normalize control and do not move it again until recalibration is required.

The pulser is now calibrated; the Pulse Height dial reads directly in MeV if the number of dial divisions is divided by 100.

### AMPLIFIER NOISE AND RESOLUTION MEASUREMENTS

As shown in Fig. 9, a preamplifier, amplifier, pulse generator, oscilloscope, and wide-band rms voltmeter such as the Hewlett-Packard 3400A are required for this measurement. Connect a suitable capacitor to the input to simulate the detector capacitance desired. To obtain the resolution spread due to amplifier noise:

- a. Measure the rms noise voltage ( $E_{rms}$ ) at the amplifier output.
- b. Turn on the 419 precision pulse generator and adjust the pulser output to any convenient readable voltage,  $E_o$ , as determined by the oscilloscope.

The full-width-half-maximum (FWHM) resolution spread due to amplifier noise is then

$$N(FWHM) = \frac{2.35 E_{rms} E_{dial}}{E_o}$$

where  $E_{dial}$  is the pulser dial reading in MeV, and 2.35 is the factor for rms to FWHM. For average-responding voltmeters such as the Hewlett-Packard 400D, the measured noise must be multiplied by 1.13 to calculate the rms noise.

The resolution spread will depend on the total input capacitance, because the capacitance degrades the signal-to-noise ratio much faster than the noise.

### DETECTOR NOISE-RESOLUTION MEASUREMENTS

The measurement just described can be made with a biased detector instead of the external capacitor that would be used to simulate detector capacitance. The resolution spread will be larger because the detector contributes both noise and

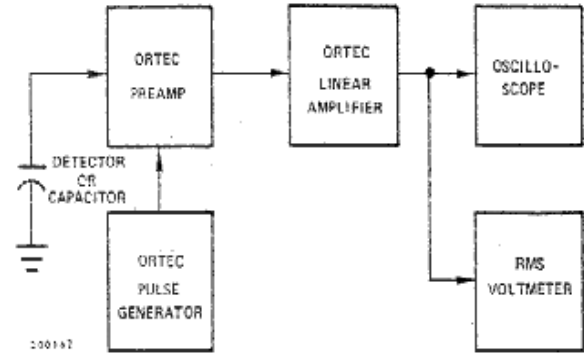

Fig. 9. System for Measuring Amplifier and Detector Noise Resolution.

capacitance to the input. The detector noise-resolution spread can be isolated from the amplifier noise spread if the detector capacitance is known, since

$$(N_{det})^2 + (N_{elec})^2 = (N_{total})^2,$$

where  $N_{total}$  is the total resolution spread, and  $N_{elec}$  is the electronic resolution spread when the detector is replaced by its equivalent capacitance.

The detector noise tends to increase with bias voltage, while the detector capacitance decreases. The net change in resolution spread will depend upon which effect is dominant. Figure 10 shows curves of typical noise-resolution spread versus bias voltage using data from several ORTEC silicon surface-barrier semi-conductor radiation detectors.

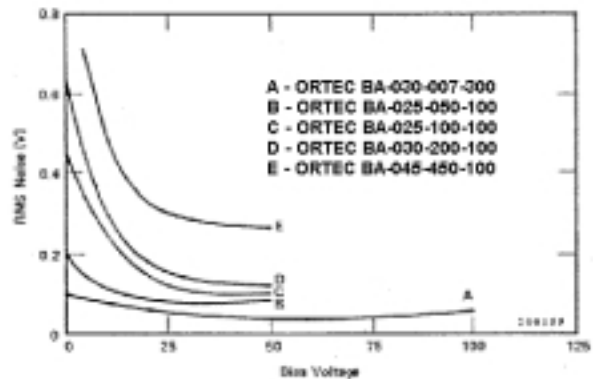

Fig. 10. Noise as a Function of Bias Voltage.

### AMPLIFIER NOISE-RESOLUTION MEASUREMENTS USING MCA

Probably the most convenient method of making resolution measurements is with a pulse height analyzer, as shown by the setup illustrated in Fig. 11.



The electronic noise-resolution spread can be measured directly with a pulse height analyzer and the mercury pulser as follows:

- Select the energy of interest with an ORTEC 419 Precision Pulse Generator. Set the amplifier and biased amplifier gain and bias level controls so that the energy is in a convenient channel of the analyzer.
- Calibrate the analyzer in keV per channel, using the pulser; full scale on the pulser dial is 10 MeV when calibrated as described above.
- Obtain the amplifier noise-resolution spread by measuring the FWHM of the pulser peak in the spectrum.

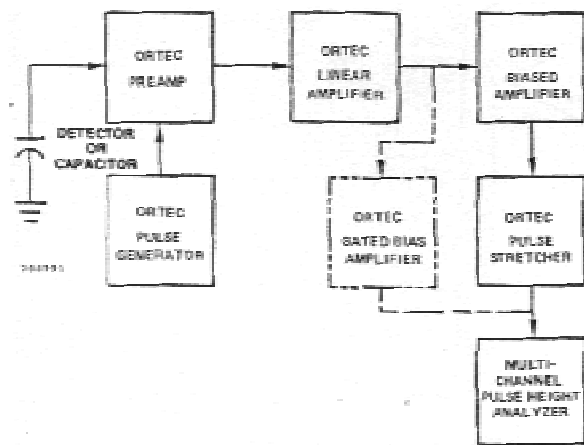

Fig. 11. System for Measuring Resolution with a Pulse Height Analyzer.

The detector noise-resolution spread for a given detector bias can be determined in the same manner by connecting a detector to the preamplifier input. The amplifier noise-resolution spread must be subtracted as described in "Detector Noise-Resolution Measurements." The detector noise will vary with detector size and bias conditions and possibly with ambient conditions.

**CURRENT VOLTAGE MEASUREMENTS FOR Si AND Ge DETECTORS** The amplifier system is not directly involved in semiconductor detector current voltage measurements, but the amplifier serves to permit noise monitoring during the setup. The detector noise measurement is a more sensitive method than a current measurement of determining the maximum detector voltage that should be used because the noise increases more rapidly than the reverse current at the onset of detector breakdown. Make this measurement in the absence of a source.

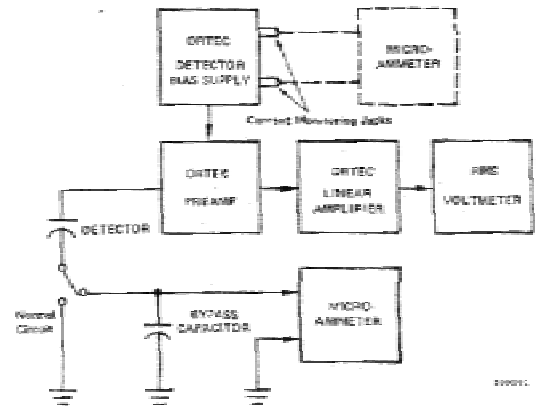

Fig. 12. System for Detector Current and Voltage Measurements.

Figure 12 shows the setup required for current voltage measurements. An ORTEC 428 Bias Supply is used as the voltage source. Bias voltage should be applied slowly and reduced when noise increases rapidly as a function of applied bias. Figure 13 shows several typical current voltage curves for ORTEC silicon surface-barrier detectors. When it is possible to float the microammeter at the detector bias voltage, the method of detector current measurement shown by the dashed lines in Fig. 12 is preferable. The detector is grounded as in normal operation, and the microammeter is connected to the current monitoring jack on the 428 detector bias supply.

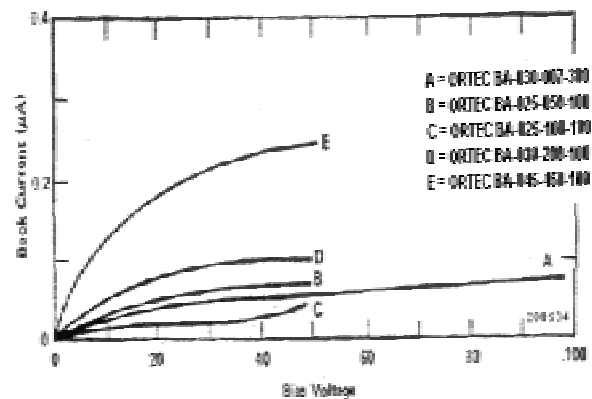

Fig. 13. Silicon Detector Back Current vs Bias Voltage.

## 4.7. OPERATION IN SPECTROSCOPY SYSTEMS

**HIGH-RESOLUTION ALPHA-PARTICLE SPECTROSCOPY SYSTEM** The block diagram of a high-resolution spectroscopy system for measuring natural alpha particle radiation is shown in Fig. 14. Since natural alpha radiation occurs only above several MeV, an ORTEC 444 Biased Amplifier is used to suppress the unused portion of the spectrum; the same result can be obtained by using digital suppression on the MCA in many cases. Alpha-particle resolution is obtained in the following manner:

- Use appropriate amplifier gain and minimum biased amplifier gain and bias level. Accumulate the alpha peak in the MCA.
- Slowly increase the bias level and biased amplifier gain until the alpha peak is spread over 5 to 10 channels and the minimum- to maximum-energy range desired corresponds to the first and last channels of the MCA.
- Calibrate the analyzer in keV per channel using the pulser and the known energy of the alpha peak (see "Calibration of Test Pulser") or two known-energy alpha peaks.
- Calculate the resolution by measuring the number of channels at the FWHM level in the peak and converting this to keV.

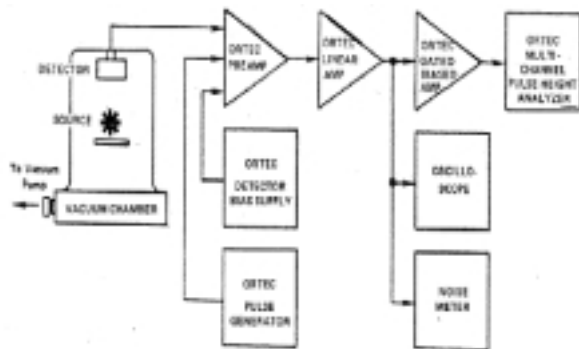

Fig. 14. System for High-Resolution Alpha-Particle Spectroscopy.

**HIGH-RESOLUTION GAMMA SPECTROSCOPY SYSTEM** A high-resolution gamma spectroscopy system block diagram is shown in Fig. 15. Although a biased amplifier is not shown (an analyzer with more channels being preferred), it can be used if the only analyzer available has fewer channels and only higher energies are of interest.

When a germanium detector that is cooled by a liquid nitrogen cryostat is used, it is possible to

obtain resolutions from about 1 keV FWHM up (depending on the energy of the incident radiation and the size and quality of the detector).

Reasonable care is required to obtain such results. Some guidelines for obtaining optimum resolution are:

- Keep interconnection capacitance between the detector and preamplifier to an absolute minimum (no long cables).
- Keep humidity low near the detector-preamplifier junction.
- Operate the amplifier with the shaping time that provides the best signal-to-noise ratio.
- Operate at the highest allowable detector bias to keep the input capacitance low.

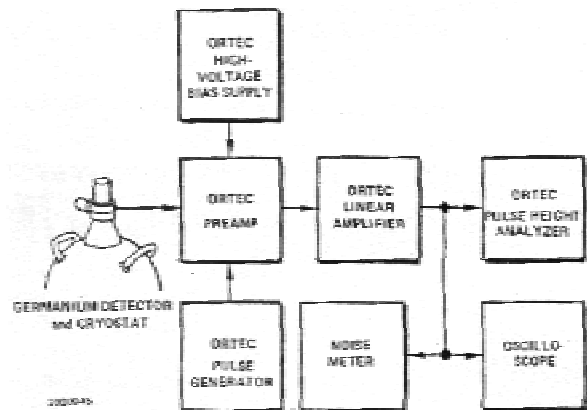

Fig. 15. System for High-Resolution Gamma Spectroscopy.

**SCINTILLATION-COUNTER GAMMA SPECTROSCOPY SYSTEMS** The ORTEC 575A can be used in scintillation-counter spectroscopy systems as shown in Fig. 16. The amplifier shaping time constants should be selected in the region of 0.5 to 1.5  $\mu$ s for NaI or plastic scintillators. For scintillators having longer decay times, longer time constants should be selected.

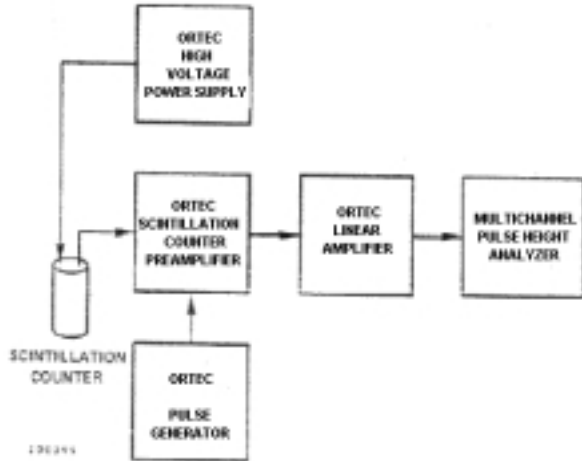

Fig. 16. Scintillation-Counter Gamma Spectroscopy System.

**X-RAY SPECTROSCOPY USING PROPORTIONAL COUNTERS** Space charge effects in proportional counters, operated at high gas amplification, tend to degrade the resolution capabilities drastically at x-ray energies, even at relatively low counting rates. By using a high-gain, low-noise amplifying system and lower gas amplification, these effects can be reduced and a considerable improvement in resolution can be obtained.

The block diagram in Fig. 17 shows a system of this type. Analysis can be accomplished by simultaneous acquisition of all data on a multichannel analyzer or counting a region of interest in a single-channel analyzer window with a counter and timer or counting ratemeter.

**4.8. OTHER EXPERIMENTS**

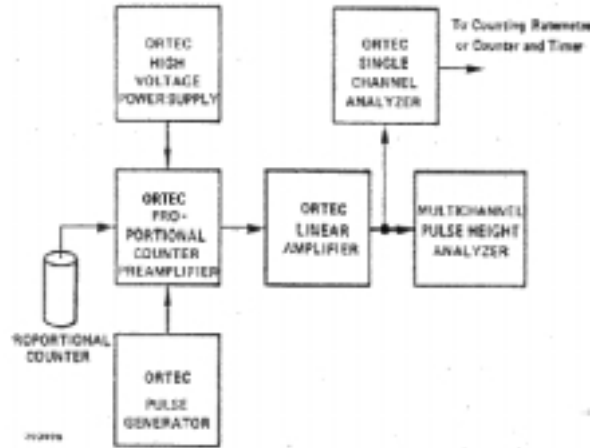

Fig. 17. High-Resolution X-Ray Energy Analysis System Using a Proportional Counter.

Block diagrams illustrating how the 575A and other ORTEC modules can be used for experimental setups for various other applications are shown in Figs. 18, 19, and 20.

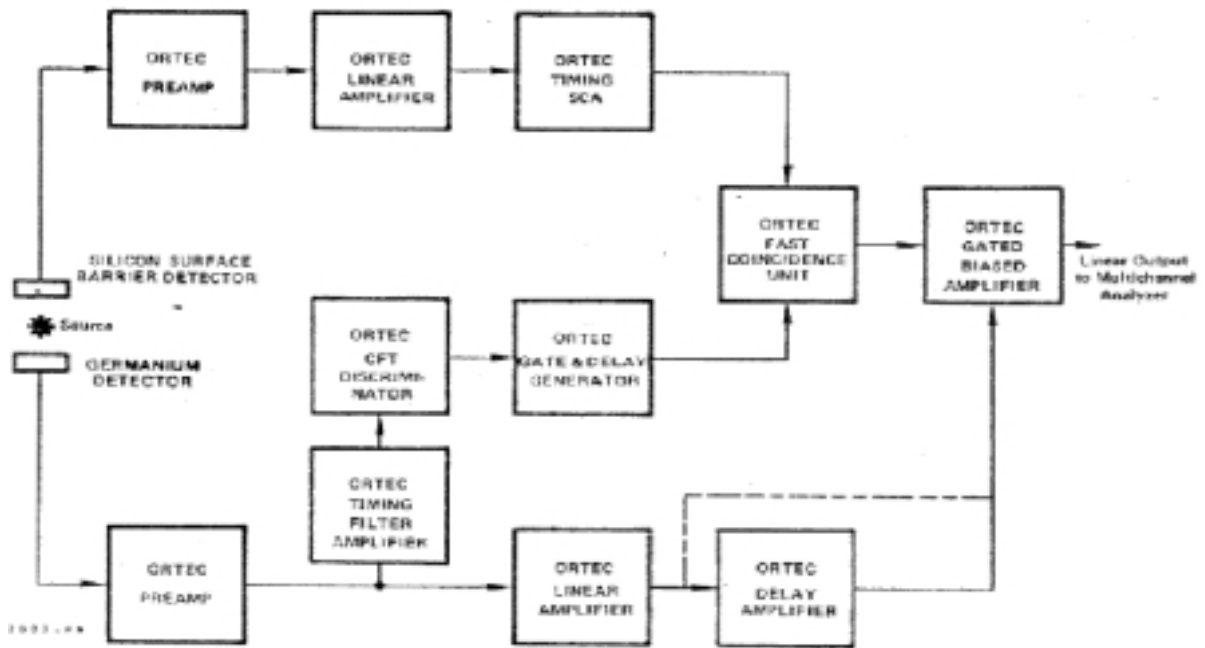

Fig. 18. Gamma-Ray Charged-Particle Coincidence Experiment.

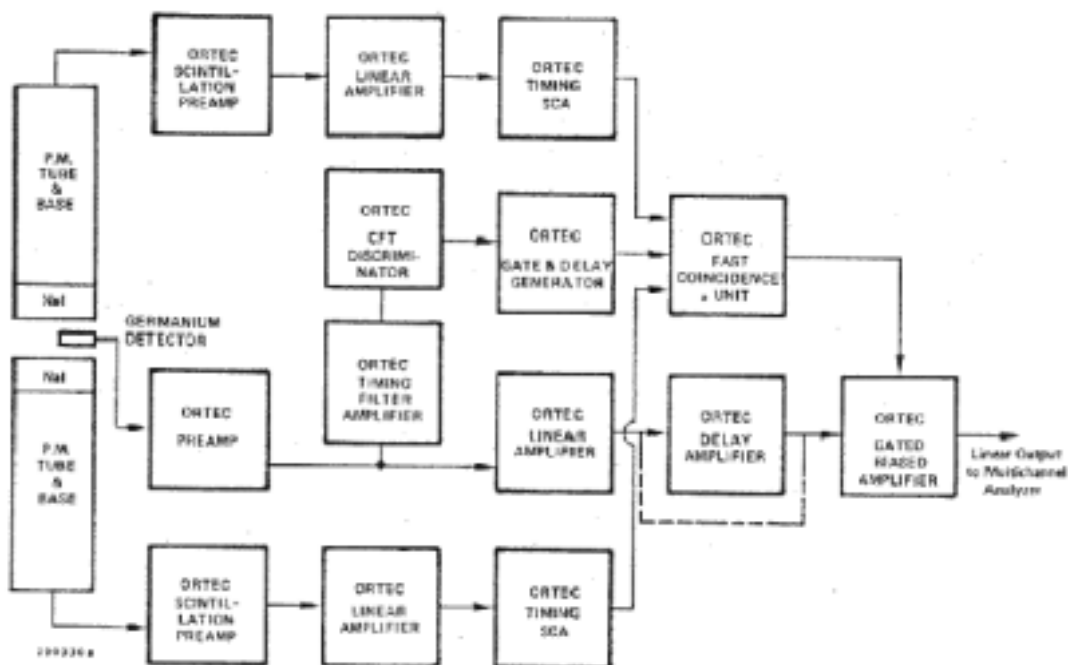

Fig. 19. Gamma-Ray Pair Spectrometry.

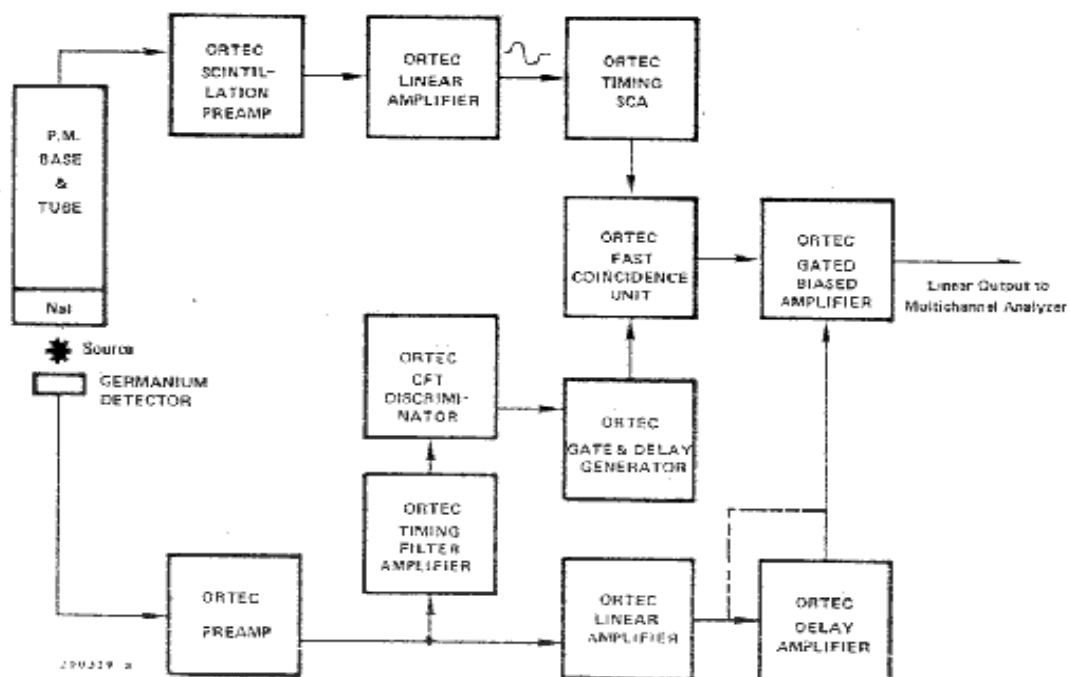

Fig. 20. Gamma-Gamma Coincidence Experiment.

## 5. MAINTENANCE

### 5.1. TEST EQUIPMENT REQUIRED

The following test equipment should be used to adequately test the specifications of the 575A amplifier:

1. ORTEC 419 Precision Pulse Generator or 448 Research Pulser.
2. Tektronix 547 Series Oscilloscope with a type 1A1 plug-in or equivalent.
3. Hewlett-Packard 3400A rms voltmeter.

### 5.2. PULSER TEST\*

**FUNCTIONAL CHECKS** Set the 575A controls as follows:

Coarse Gain	100
Gain	7.5
Input Polarity	Neg
Shaping Time Constant	1.5 $\mu$ s

- Connect a positive pulser output to the 575A input and adjust the pulser to obtain +10V at the unipolar output. This should require an input pulse of 13.3 mV using a 100- $\Omega$  terminator at the input. Adjust PZ if necessary.
- Change the input polarity switch to Pos and then back to Neg while monitoring the output for a polarity inversion.
- Monitor the bipolar output for dc level of  $<\pm 5$  mV; pulse shape should be bipolar. Return to UNI.
- Recheck the output pulse amplitude and adjust if necessary to set it at +10 V with maximum gain. Decrease the Coarse Gain switch stepwise from 100 to 2 and ensure that the output amplitude changes by the appropriate amount for each step. Return the Coarse Gain switch to 100.
- Decrease the Gain control from 7.5 to 2.5 and check to see that the output amplitude decreases by a factor of 2. Return the Gain control to maximum at 7.5.
- With the shaping jumpers set for 1.5  $\mu$ s measure the time to the peak on the unipolar output pulse; this should be 3.3  $\mu$ s (or 2.27).

Measure the time to baseline crossover of the bipolar output; this should be 5.0  $\mu$ s (or 3.37).

- Change the shaping jumpers to 0.5 and 3  $\mu$ s in turn. At each setting, check to see that the time to the unipolar peak is 2.27. Return the jumpers to 1.5  $\mu$ s.

**OVERLOAD TESTS** Start with maximum gain,  $T = 1.5$   $\mu$ s, and a +10 V output amplitude. Increase the pulser output amplitude by  $\times 200$  and observe that the unipolar output returns to within 200 mV of the baseline within 24  $\mu$ s after the application of a single pulse from the pulser. It will probably be necessary to vary the PZ ADJ control on the front panel in order to cancel the pulser pole and minimize the time required for return to the baseline.

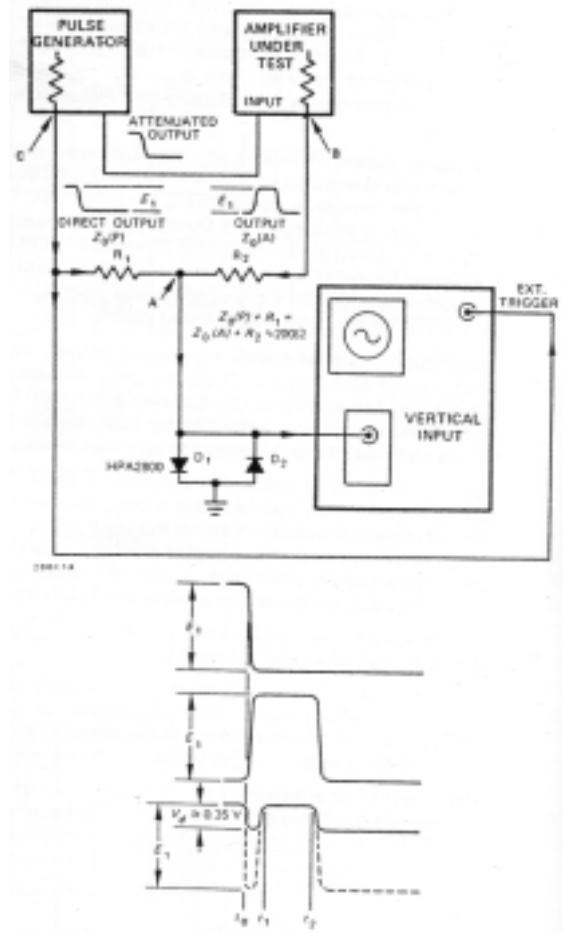

Fig. 21. Circuit Used to Measure Nonlinearity.

\*See IEEE Standards No. 301-1976.

**LINEARITY** The integral nonlinearity of the 575A can be measured by the technique shown in Fig. 21. In effect, the negative pulser output is subtracted from the positive amplifier output to cause a null point that can be measured with excellent sensitivity. The pulser output must be varied between 0 to 10 V, which usually requires an external control source for the pulser. The amplifier gain and the pulser attenuator must be adjusted to measure 0 V at the null point when the pulser output is 10 V. The variation in the null point as the pulser is reduced gradually from 10 V to 0 V is a measure of the nonlinearity. Since the subtraction network also acts as a voltage divider, this variation must be less than

$$(10 \text{ V full scale}) \times (\pm 0.05\% \text{ maximum nonlinearity}) \\ \times (1/2 \text{ for divider network}) \\ = \pm 2.5 \text{ mV for the maximum null-point variation.}$$

**OUTPUT LOADING** Use the test setup of Fig. 21. Adjust the amplifier output to 10 V and observe the null point when the front panel output is terminated in 100  $\Omega$ . The change should be <2.5 mV.

**NOISE** Measure the noise at the amplifier unipolar output with maximum amplifier gain and 3- $\mu$ s shaping time. Using a true-rms voltmeter, the noise should be <5  $\mu$ V  $\times$  750 (gain), or 3.75 mV.

For an average responding voltmeter, the noise reading would have to be multiplied by 1.13 to calculate the rms noise. The input must be terminated in 100 $\Omega$  during the noise measurements.

### 5.3. SUGGESTIONS FOR TROUBLESHOOTING

In situations where the 575A is suspected of a malfunction, it is essential to verify such malfunction in terms of simple pulse generator impulses at the input. The unit must be disconnected from its position in any system, and routine diagnostic analysis performed with a test pulse generator and oscilloscope. It is imperative that the testing not be performed with a source and detector until the amplifier performs satisfactorily with the test pulse generator.

The testing instructions in Section 5.2 should provide assistance in locating the region of trouble and repairing the malfunction. The two side plates

can be completely removed from the module to enable oscilloscope and voltmeter observations.

### 5.4. FACTORY REPAIR

This instrument can be returned to the ORTEC factory for service and repair at a nominal cost. Our standard procedure for repair ensures the same quality control and checkout as for a new instrument. Always contact Customer Services at ORTEC, (865) 483-2231, before sending in an instrument for repair to obtain shipping instructions. A Return Authorization Number is required and will be assigned to the unit. This number should be marked on the address label and on the package to ensure prompt attention when the unit reaches the factory.

### 5.5. TABULATED TEST POINT VOLTAGES

The voltages given in Table 5.1 are intended to indicate typical dc levels that can be measured on the PWB. In some cases the circuit will perform satisfactorily even though, due to component tolerances, there may be some voltage measurements which differ slightly from the listed values. The tabulated values should not be interpreted as absolute voltages but rather should be used as an aid during troubleshooting.

**Table 5.1. Typical dc Voltages**

Note: All voltages measured with no input signal, with the input terminated in 100  $\Omega$ , and all controls set fully clockwise at maximum.

Location	Voltage
T1	$\pm 50$ mV
T2	$\pm 60$ mV
T3	$\pm 0.7$ V
T4	$\pm 1.0$ V
T5	$\pm 60$ mV
T6	0 to - 0.8 V
T7	$\pm 6$ mV

**Bin/Module Connector Pin Assignments  
For Standard Nuclear Instrument Modules  
per DOE/ER-0457T.**

<b>Pin</b>	<b>Function</b>	<b>Pin</b>	<b>Function</b>
1	+3 V	23	Reserved
2	-3 V	24	Reserved
3	Spare bus	25	Reserved
4	Reserved bus	26	Spare
5	Coaxial	27	Spare
6	Coaxial	*28	+24 V
7	Coaxial	*29	-24 V
8	200 V dc	30	Spare bus
9	Spare	31	Spare
*10	+6 V	32	Spare
*11	-6 V	*33	117 V ac (hot)
12	Reserved bus	*34	Power return ground
13	Spare	35	Reset (Scaler)
14	Spare	36	Gate
15	Reserved	37	Reset (Auxiliary)
*16	+12 V	38	Coaxial
*17	-12 V	39	Coaxial
18	Spare bus	40	Coaxial
19	Reserved bus	*41	117 V ac (neutral)
20	Spare	*42	High-quality ground
21	Spare	G	Ground guide pin
22	Reserved		

Pins marked (\*) are installed and wired in ORTEC's 4001A and 4001C Modular System Bins.