

(revised 1/23/13)

## RAMSAUER - TOWNSEND EFFECT

Advanced Laboratory, Physics 407,  
University of Wisconsin  
Madison, Wisconsin 53706

### **Abstract**

The scattering cross section of electrons on noble gas atoms exhibits a very small value at electron energies near 1 eV. This is the Ramsauer-Townsend effect and provides an example of a phenomenon which requires a quantum mechanical description of the interaction of particles.

## Theory

The Ramsauer-Townsend effect can be observed as long as the scattering does not become inelastic by excitation of the first excited state of the atom. This condition is best fulfilled by the closed shell noble gas atoms. Physically, the Ramsauer-Townsend effect may be thought of as a diffraction of the electron around the rare-gas atom, in which the wave function inside the atom is distorted in just such a way that it fits smoothly to an undistorted wave function outside. The effect is analagous to the perfect transmission found at particular energies in one-dimensional scattering from a square well. Appendix A (from Ref.[2]) contains a one-dimensional treatment of scattering from a square well. This is the first model which you will use to analyze the data. A three-dimensional treatment using partial waves is given in Ref. [4], pp 396-402.

## Apparatus

### Thyratron - (RCA 2D21)

The tube contains Xenon gas. The assembly is mounted on a stand so that the filament of the tube is uppermost and so that the tube may be dipped into a liquid nitrogen dewar. (Note that the voltages being used here are NOT the voltages which are normally used in thyratron circuits).

### Regulated DC Power Supply

The supply provides the voltage to accelerate the electrons. The supply provides 0 to 30 volts but is difficult to adjust for very low voltages. For this reason a control box containing a potentiometer is used to accurately set the lower voltages.

### 4-Volt Transformer

The transformer provides the power for the thyratron filament. The tube normally uses 6.3 volts AC but by running the cathode at a lower temperature the spread in electron energies is reduced. The transformer is contained in the control box.

## **Dewar Flask**

The dewar will hold the liquid nitrogen necessary for freezing out the Xenon in the thyratron tube. The cold data is used to correct for thyratron geometry effects.

## **Digital Multimeters - (6 1/2 digit Keithley 2100)**

These are high impedance meters used to measure the plate voltage,  $V_p$ ; the shield voltage,  $V_s$ ; and the cathode to shield voltage,  $(V - V_s)$ .

## **Ramsauer.exe Program**

The ramsauer.exe program will allow you to record all the DVM readings in a .txt file which you can name. The program will also plot the  $V - V_s$  readings and both  $V_p$  and  $V_s$  as a function of  $V - V_s$ .

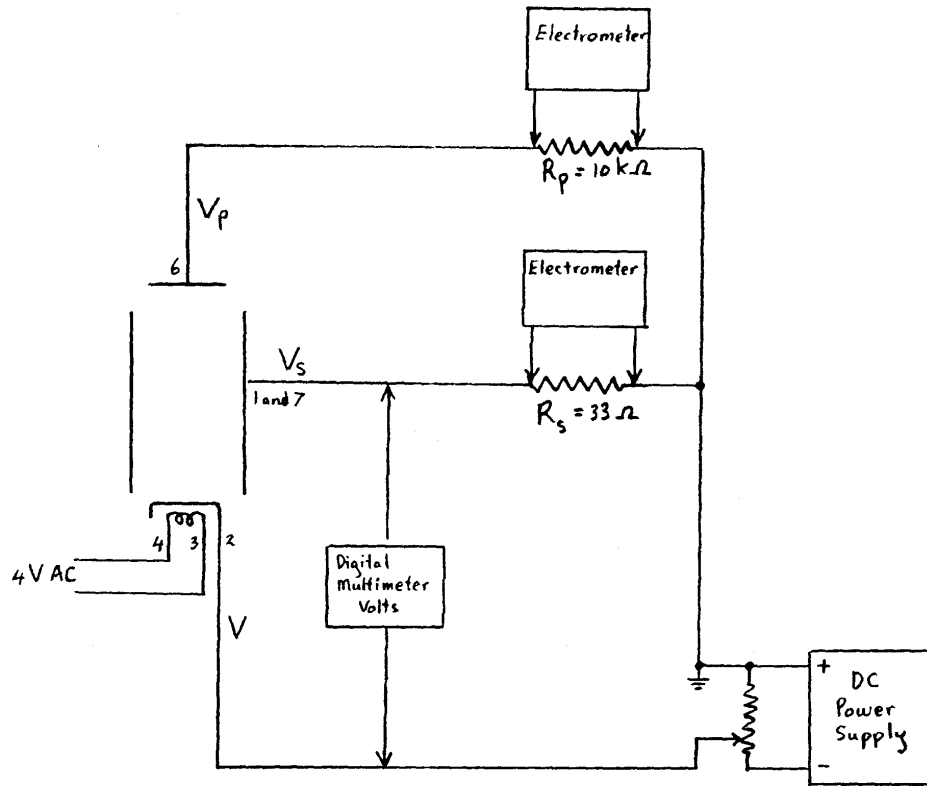

Circuit

Diagram

Thratron Socket Wiring Color Code

Pin	Internal Connection	Color of Wire
1	grid #1	green*
2	cathode	black
3	heater	red
4	heater	red
5	shield (grid #2)	no connection
6	anode	yellow
7	shield (grid #2)	green*

\* grid #1 and shield (grid #2) are joined externally

## Demonstration of the Ramsauer-Townsend Effect in a Xenon Thyatron

STEPHEN G. KUKOLICH

*Department of Physics, Massachusetts Institute of Technology, Cambridge, Massachusetts 02139*

(Received 15 January 1968; revision received 15 April 1968)

The anomalously small scattering of electrons near 1 eV energy by noble gas atoms may be easily demonstrated using a 2D21 xenon thyatron. This experiment is suitable for a lecture demonstration or for an undergraduate physics laboratory. The probability of scattering and the scattering cross section may be obtained as a function of electron energy by measuring the grid and plate currents in the tube.

The scattering cross section for electrons on noble gas atoms exhibits a very small value at electron energies near 1 eV. This cross section is much smaller than that obtained from measurements involving atom-atom collisions. This is the Ramsauer-Townsend effect and provides an example of a phenomenon which requires a quantum mechanical description of the interaction of particles. If the atoms are treated classically as hard spheres, the calculated cross section is independent of the incident electron energy and we cannot account for the Ramsauer-Townsend effect. If the noble-gas atoms are considered to present an attractive potential (e.g., square well, screened Coulomb) of typical atomic dimensions, the solution of the Schrödinger equation for the electrons indicates that the cross section will have a minimum at electron energies near 1 eV. Reviews of the Ramsauer-Townsend effect are given by Mott and Massey<sup>1</sup> and Brode.<sup>2</sup>

<sup>1</sup>N. F. Mott and H. S. W. Massey, *The Theory of Atomic Collisions* (Oxford University Press, London, 1965), 3rd ed., Chap. 18.

<sup>2</sup>R. B. Brode, *Rev. Mod. Phys.* **5**, 257 (1933).

The problem of scattering of electrons by a square well is considered in many introductory quantum physics texts.<sup>3-7</sup> The one-dimensional model predicts that the scattering will go to zero whenever half the electron wavelength in the well is a multiple of the well width. The difficulty with this model is that only one distinct minimum is observed.

A slightly better model of the xenon atom is a three dimensional square well. Then the scattering cross section will have a very small value when the phase shift  $\delta_0$  of the  $l=0$  partial wave is  $\pi$ . Here the scattering due to the  $l=0$  partial wave will vanish and the scattering due to higher  $l$  partial waves will be small if the width of the

<sup>3</sup>L. I. Schiff, *Quantum Mechanics* (McGraw-Hill Book Co., New York, 1955), Chap. 5.

<sup>4</sup>E. Merzbacher, *Quantum Mechanics* (John Wiley & Sons, Inc., New York, 1955), Chaps. 6, 12.

<sup>5</sup>D. Bohm, *Quantum Theory* (Prentice-Hall Inc., Englewood Cliffs, N.J., 1951), Chaps. 11.9, 21.51.

<sup>6</sup>A. Messiah, *Quantum Mechanics I* (North-Holland Publ. Co., Amsterdam, 1961), Chaps. III-6.

<sup>7</sup>R. M. Eisberg, *Fundamentals of Modern Physics* (John Wiley & Sons, Inc., N.Y., 1961), Chap. 15.

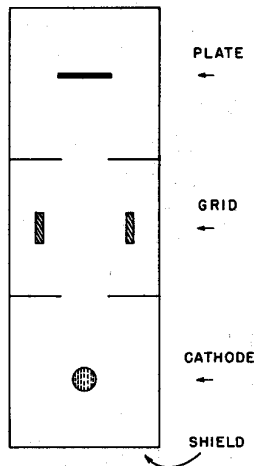

FIG. 1. Cross section of the 2D21 thyratron.

well is small.<sup>1</sup> When the  $l=0$  phase shift becomes  $2\pi$ , or higher  $l$  phase shifts become  $\pi$  at higher values of electron energy, the dips in the cross section will not be as prominent since contributions from other values of  $l$  will not be small. The well parameters may be adjusted to give a minimum at the observed energy. This model predicts the Ramsauer-Townsend effect in a qualitative way, but does not give quantitative agreement over a wide range of electron energies. The results of more accurate calculations with a screened coulomb potential are given by Mott and Massey.<sup>1</sup>

I. THE EXPERIMENT

The 2D21 thyratron is very well suited for a demonstration of the Ramsauer effect. The shield (grid 2) is a boxlike structure with three sections

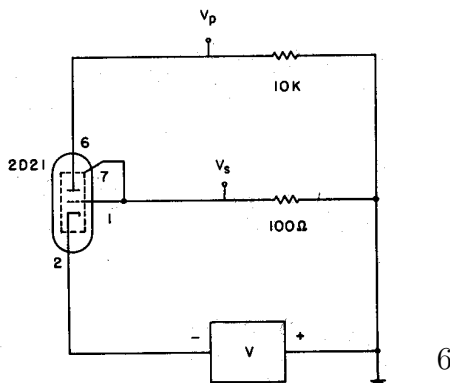

FIG. 2. Diagram of the circuit for the Ramsauer effect experiment. The filament of the 2D21 (pins 3, 4) is heated by 4 V dc.

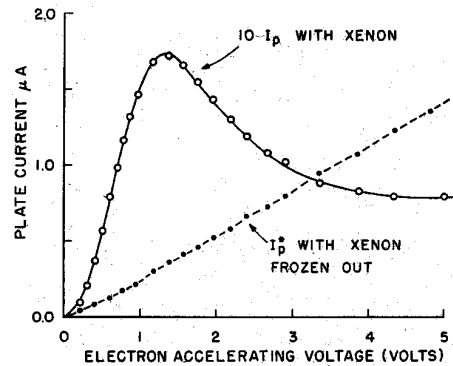

FIG. 3. The plate current  $I_p$  as a function of the voltage  $V$ , and  $I_p^*$  the plate current with the xenon frozen out with liquid nitrogen.

connected by apertures (see Fig. 1). The electron beam originates at the cathode in the first section, passes through the second section, and part of it is collected on the plate in the third section. The xenon pressure in the tube is approximately 0.05 Torr. A diagram of the circuit is shown in Fig. 2. The shield current is proportional to the intensity of the electron beam at the first aperture. After the first aperture the beam passes through an equipotential region where the scattering takes place. In this region the beam intensity is  $J = J_0 e^{-x/\lambda}$ , where  $\lambda$  is the mean free path. If the plate is a distance  $l$  from the first aperture, the intensity at the plate is  $J_p = J_0 e^{-l/\lambda}$  or  $J_p = J_0(1 - P_s)$ , where  $P_s$  is the probability of scattering. The plate current is  $I_p = I_s f(V)(1 - P_s)$ , where  $I_s$  is

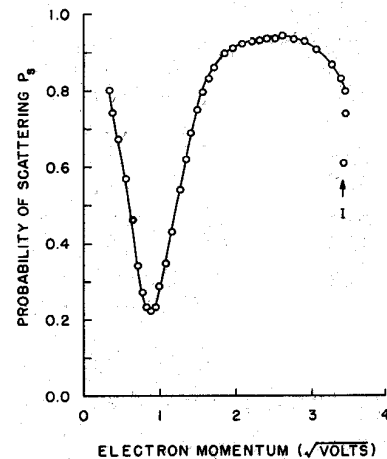

FIG. 4. The probability of scattering  $P_s$  as a function of  $(V - V_s)^{1/2}$ , where  $V - V_s$  is the electron energy. Ionization occurs at "I".

the shield current and  $f(V)$  is a geometrical factor which contains the ratio of the angle intercepted by the plate to the angle intercepted by the shield and a factor due to space charge effects near the cathode. To measure  $f(V)$  we freeze out the xenon by dunking the top of the tube in liquid nitrogen. This reduces the xenon pressure to  $\sim 10^{-3}$  Torr and  $P_s$  becomes very small so we get  $f(V) \cong I_p^*/I_s^*$ . Now we have  $P_s = 1 - I_p I_s^*/I_s I_p^*$ . Figure 3 shows that  $I_p$  has a maximum near 1 eV and that  $I_p/I_p^*$  approaches one there, indicating that there is very little scattering. At higher energies  $I_p/I_p^*$  is very small indicating a large probability of scattering. A plot of  $P_s$  calculated from the data using the above equation is shown in Fig. 4.

The probability of scattering is related to the mean free path by the relation  $P_s = 1 - e^{-l/\lambda}$ . For the 2D21  $l = 0.7$  cm so we can calculate  $\lambda$ . The cross section  $\sigma$  is related to  $\lambda$  by  $n\sigma = 1/\lambda$ , where  $n$  is the number of atoms per unit volume. A plot obtained from our values of  $P_s$  is shown in Fig. 5. A similar set of data for  $P_c$  ( $P_c = P/\lambda$ , where  $P$  is the pressure in Torr) given by Brode<sup>7</sup> is shown in Fig. 6. In the 2D21 fairly large angular deflections must be produced to scatter an electron out of the beam (greater than  $\sim 0.2$  rad) so the cross section measured in the 2D21 will be smaller than Brode's data.

## II. EXPERIMENTAL DETAILS

The filament of the 2D21 is operated on 4 V dc. This is lower than the recommended value of

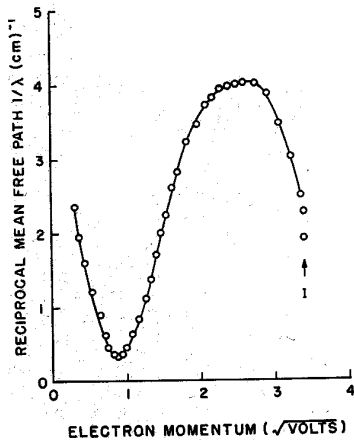

Fig. 5. The cross section times density  $n\sigma = 1/\lambda$  as a function of  $(V - V_s)^{1/2}$ , where  $V - V_s$  is the electron energy. Ionization occurs at "I".

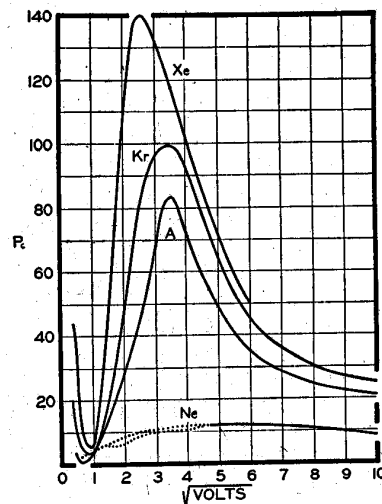

Fig. 6. The probability of collision  $P_c$  (= pressure times  $n\sigma$ ) as a function of  $(V)^{1/2}$  where  $V$  is the electron energy (from Brode see Ref. 2).

6.3 V, but tends to reduce space charge effects. Since the cathode temperature is lower, the thermal kinetic energy of the electrons is smaller and this will result in a narrower distribution of electron energies. The shield and plate currents are obtained by measuring the voltages  $V_s$  and  $V_p$  with two Keithley model 600A electrometers (see Fig. 2). The voltage source  $V$  is a well regulated and filtered supply which may be varied between 0-15 V. The electron energy plotted in the figures is  $V - V_s$ . We have not included a correction for the contact potential difference between the cathode and the shield. This contact potential difference is approximately 0.4 V and was measured by noting that ionization occurs when  $V - V_s$  is 0.4 V less than the tabulated ionization potential. A similar value was obtained by measuring the value of  $V$  required to cut off the electron current to the shield. The voltages  $V_s$  and  $V_p$  range from a few millivolts to a few tenths of a volt. The data may be displayed on an oscilloscope by using an audio oscillator for the source  $V$  and for the  $x$  axis of the scope.

## ACKNOWLEDGMENT

This experiment was suggested by Professor R. Weiss as a demonstration in an introductory course in quantum physics given by him at MIT.



2D21  
THYRATRON

RELAY and GRID-CONTROLLED RECTIFIER SERVICE

Maximum Ratings, Absolute Values:

PEAK ANODE VOLTAGE:	650 max. volts
Forward:	1300 max. volts
Inverse:	-100 max. volts
GRID-No.2 (SHIELD-GRID) VOLTAGE:	-100 max. volts
Peak, before anode conduction:	-100 max. volts
Average, during anode conduction:	-10 max. volts
GRID-No.1 (CONTROL-GRID) VOLTAGE:	-100 max. volts
Peak, before anode conduction:	-10 max. volts
Average, during anode conduction:	-10 max. volts
CATHODE CURRENT:	0.5 max. amp
Peak:	0.1 max. amp
Average:	10 max. amp
Surge, for duration of 0.1 sec. max.:	+0.01 max. amp
Average:	+0.01 max. amp
GRID-No.1 CURRENT:	100 max. volts
Peak heater-cathode voltage:	25 max. volts
Heater positive with respect to cathode:	-75 to +90 volts
AMBIENT TEMPERATURE RANGE:	-75 to +90 °C

Typical Operating Conditions for Relay Service:

RMS Anode Voltage:	117	400	volts
Grid-No.2 Voltage:	0	0	volts
RMS Grid-No.1 Bias Voltage:	5	5	volts
DC Grid-No.1 Bias Voltage:	-6	-6	volts
Peak Grid-No.1 Signal Voltage:	5	6	volts
Grid-No.1-Circuit Resistance:	1.0	1.0	megohms
Anode-Circuit Resistance:	1200	2000	ohms

Maximum Circuit Values:

Grid-No.1-Circuit Resistance:	10 max. megohms
-------------------------------	-----------------

A Averaged over any interval of 30 sec. max.  
 B Approximately 100 out of phase with the anode voltage.  
 C Sufficient resistance, including the tube load, must be used under any conditions of operation to prevent exceeding the current ratings.  
 → indicates a change.

JUNE 15, 1948  
TUBE DEPARTMENT  
RCA CORPORATION OF AMERICA, HUNTSVILLE, NEW ALBANY, INDIANA  
DATA



2D21  
THYRATRON

AVERAGE GRID CHARACTERISTICS BEFORE ANODE CONDUCTION

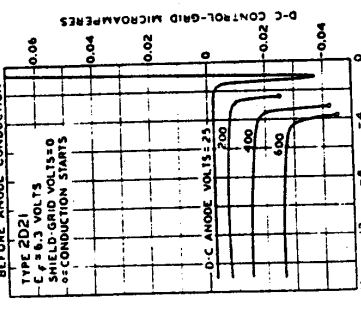

AVERAGE GRID CHARACTERISTICS DURING ANODE CONDUCTION

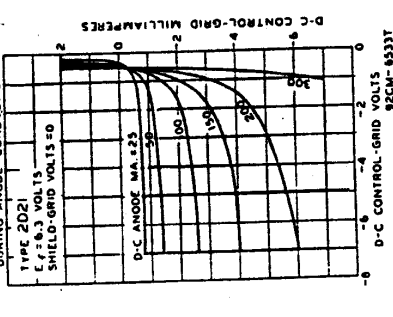

APRIL 1, 1944  
RCA VACUUM DIVISION  
RCA CORPORATION OF AMERICA, HUNTSVILLE, NEW ALBANY, INDIANA  
92CM-6532T1  
92CM-6533T



2D21  
THYRATRON

GENERAL DATA

Electrical:			
Heater, for Unipotential Cathode:	Min.	Av.	Max.
Voltage (AC or DC):	5.7	6.3	6.9
Current, with heater volts = 6.3:	0.54	0.60	0.66
Cathode:			
Heating Time, prior to tube conduction:	10		sec
Direct Interleaved Capacitances (Approx.):			
Grid No.1 to Anode:	0.026		µf
Input:	2.4		µf
Output:	1.6		µf
Ionization Time (Approx.):			
For conditions: dc anode volts 100; grid-No.1 square-pulse volts = 90; peak anode amp. during conduction 0.5:	0.5		µsec
Deionization Time (Approx.):			
For conditions: dc anode volts = 125; grid-No.1 volts = -100; grid-No.1 resistor (ohms) = 1000; dc anode amp. = 0.1:	35		µsec
For conditions: dc anode volts = 125; grid-No.1 volts = -10; grid-No.1 resistor (ohms) = 1000; dc anode amp. = 0.1:	75		µsec
Maximum Critical Grid Current, with ac anode supply volts (rms) = 450, and average anode amp. = 0.1:	0.5		µamp
Anode Voltage Drop (Approx.):	8		volts
Grid-No.1 Control Ratio (Approx.) with grid-No.1 resistor (megohms) = 0; grid-No.2 volts = 0:	250		
Grid-No.2 Control Ratio (Approx.) with grid-No.1 resistor (megohms) = 0; grid-No.2 resistor (megohms) = 0; grid-No.1 volts = 0:	1000		
0 without external shield.			
Mechanical:			
Mounting Position:	Any		
Maximum Overall Length:	2-1/8"		
Maximum Seated Length:	1-7/8"		
Length, Base Seat to Bulb Top (excluding tip):	1-1/2" ± 3/32"		
Bulb:	T-5-1/2"		
Maximum Diameter:	3/4"		
Base:	Snail-Button Miniature 7-Pin		
Basing Designation for BOTTOM VIEW:	Pin 5-Grid No.2 Pin 6-Anode Pin 7-Grid No.2 Pin 1-Grid No.1 Pin 2-Cathode Pin 3-Heater Pin 4-Heater		

JUNE 15, 1948  
TUBE DEPARTMENT  
RCA CORPORATION OF AMERICA, HUNTSVILLE, NEW ALBANY, INDIANA  
DATA





2D21

THYRATRON

AVERAGE CONTROL CHARACTERISTICS

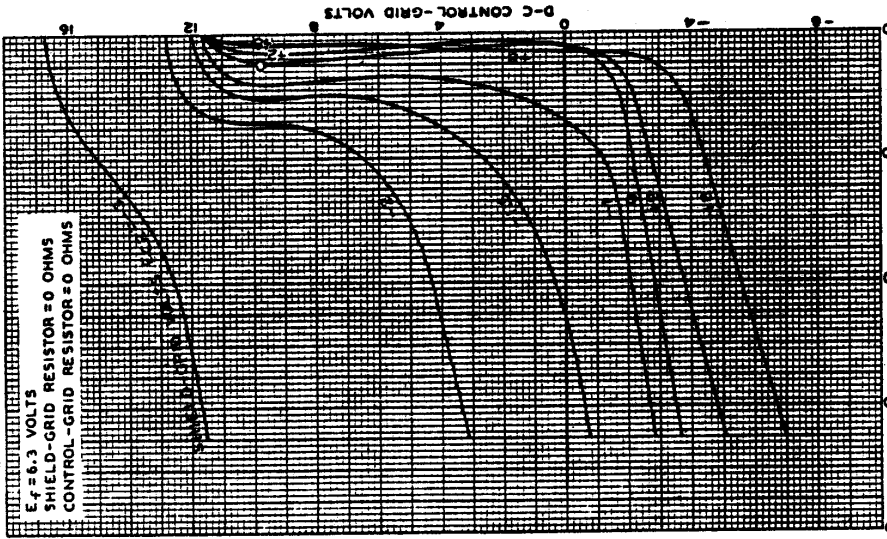

MAY 2, 1944  
 RCA VACUUM DIVISION  
 92CM-6531R1  
 BASED ON CHARACTERISTICS OF TYPICAL TUBES, SEE NOTE



2D21

THYRATRON

OPERATIONAL RANGE OF CRITICAL GRID VOLTAGE

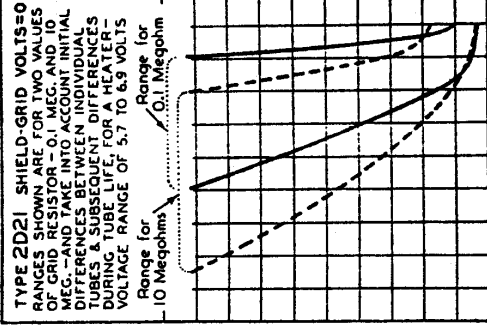

Range for 10 Megohms  
 Range for 0.1 Megohm  
 92CM-6534T2

JUNE 15, 1948  
 TUBE DEPARTMENT  
 BASED ON CHARACTERISTICS OF TYPICAL TUBES, SEE NOTE  
 CE-6534T2

## Procedure

1. Read the article by S.G. Kukolich in the Am. Jour. Phys. 36, 1968 and understand the one-dimensional scattering from a square well.
2. Set up the circuit as in the diagram on page 4.
3. Allow 5 minutes for the tube filament, cathode and multimeters to heat up and become stable.
4. In order for the ramsauer.exe program to display correctly the DVMs have to be connected to the control box in a specific way. The bottom DVM (V1) should connect to  $V - V_s$  as a negative voltage. The middle DVM (V2) connects to the grid ( $V_s$ ) and the top DVM (V3) connects to the plate ( $V_p$ ). The program will enter the DVM readings into a file (which you will name) by clicking on the READ button. The Append/Overwrite button should be set to Append for data taking. The file may be viewed by clicking on the ViewLogFile button. The file can be saved as a.txt file and viewed externally with WordPad.
5. Measure the voltages  $V_s$  and  $V_p$  as a function of the cathode to shield voltage ( $V - V_s$ ) with the thyratron at room temperature. Use values of ( $V - V_s$ ) as follows:

from	0.25	to	1.00	volts in steps of	0.1	volts
	1.00	to	2.00	volts in steps of	0.1	volts
	2.00	to	3.00	volts in steps of	0.2	volts
	3.00	to	5.00	volts in steps of	0.5	volts
	5.00	to	10.00	volts in steps of	1.0	volts

The purpose of the uneven steps is to give the best detail between 0.3 and 1.0 on the plot of  $\sqrt{V - V_s}$ . Above 10 V the Xenon begins to ionize and the tube currents become large. The true accelerating potential will be different from ( $V - V_s$ ) due to the contact potential difference cathode and shield. The contact potential has to be measured separately to make this correction.

6. Turn off the filament and gently immerse only the lower blackened part of the thyratron in liquid nitrogen. Allow it to cool for 15 minutes then turn on the filament again and allow a further 5 minutes for temperatures to stabilize. The Xenon will have condensed and frozen at the cold end of the tube.

7. Repeat measurements of Step 4 above at the same values of  $(V - V_s)$  to obtain  $V_s^*$  and  $V_p^*$ . Adjust the tube from time to time to keep the lower end in the liquid nitrogen.
8. Plot  $I_p$  and  $I_p^*$  against  $\sqrt{V - V_s}$ .
9. Calculate the probability of transmission (no scattering):

$$T = \frac{I_p I_s^*}{I_s I_p^*}.$$

Since  $V_p = I_p R_p$

$$V_p^* = I_p^* R_p$$

$$V_s = I_s R_s$$

$$V_s^* = I_s^* R_s,$$

it is easier to calculate:

$$T = \frac{V_p V_s^*}{V_s V_p^*}.$$

Plot  $T$  against  $\sqrt{V - V_s}$  (which is proportional to the electron momentum).

Plot  $T$  against  $V - V_s$  (which is proportional to the electron energy).

Note the value of  $(V - V_s)$  corresponding to maximum  $T$ . Correct your result for the contact potential difference.

The contact potential is best determined by measuring the the value of  $V - V_s$  which makes the grid current  $I_s$  equal to zero. If there were no contact potential,  $I_s = 0$  would correspond to  $V - V_s = 0$ . You will find that the required value of  $V - V_s$  to make  $I_s = 0$  is a reverse polarity. Reverse the power supply voltage and take data with increasing  $(V - V_s)$  so that the the value of  $(V - V_s)$  which makes  $I_s = 0$  can be determined. The value of this offset voltage will be the contact potential.

10. Assume that the diameter of a Xenon atom is about 2.8 Å (Xenon is smaller than Cesium (5.5 Å) because Xenon has closed shells). From your data and using one-dimensional Quantum Mechanics estimate the average depth of the square well seen by the electrons.

11. A somewhat more realistic result for the depth of the square well seen by the electrons can be made by using the three-dimensional square well as a model. Theory predicts that the scattering will be a minimum when the phase shift  $\delta_0$  of the  $\ell = 0$  partial wave is  $n\pi$  provided that all other partial wave contributions are negligible. The condition that the wave function and its derivative must be continuous at the boundary  $r = a$  then becomes

$$k_2 a \tan k_1 a = k_1 a \tan k_2 a$$

where  $k = \frac{2\pi}{\lambda}$ ,  $\lambda_1 =$  wave length of the electron inside the square well, and  $\lambda_2 =$  wave length of the free electron. Use this relation to make another estimate of the depth of the square well.

## References

- [1] "Demonstration of the Ramsauer - Townsend Effect in a Xenon Thyatron", S.G. Kukolich, Am. J. Phys. **36**, 1968, pages 701 - 701, included in this description.
- [2] *An Introduction to Quantum Physics* (Norton, 1978), A.P. French and E.F. Taylor,
- [3] *Quantum Mechanics, 3rd Ed.* (Wiley, 1998), E. Merzbacher.
- [4] *Modern Physics and Quantum Mechanics* (Saunders, 1971), E.E. Anderson.