

Entangled photons, nonlocality, and Bell inequalities in the undergraduate laboratory

Dietrich Dehlinger and M. W. Mitchell

Citation: *American Journal of Physics* **70**, 903 (2002); doi: 10.1119/1.1498860

View online: <http://dx.doi.org/10.1119/1.1498860>

View Table of Contents: <http://scitation.aip.org/content/aapt/journal/ajp/70/9?ver=pdfcov>

Published by the [American Association of Physics Teachers](#)



Re-register for Table of Content Alerts

Create a profile.

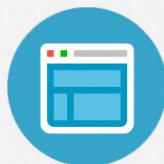

Sign up today!



Entangled photons, nonlocality, and Bell inequalities in the undergraduate laboratory

Dietrich Dehlinger and M. W. Mitchell^{a)}

Physics Department, Reed College, 3203 SE Woodstock Boulevard, Portland, Oregon 97202

(Received 3 December 2001; accepted 13 June 2002)

We use polarization-entangled photon pairs to demonstrate quantum nonlocality in an experiment suitable for advanced undergraduates. The photons are produced by spontaneous parametric downconversion using a violet diode laser and two nonlinear crystals. The polarization state of the photons is tunable. Using an entangled state analogous to that described in the Einstein–Podolsky–Rosen paradox, we demonstrate strong polarization correlations of the entangled photons. Bell’s idea of a hidden variable theory is presented by way of an example and compared to the quantum prediction. A test of the Clauser, Horne, Shimony, and Holt version of the Bell inequality finds $S = 2.307 \pm 0.035$, in clear contradiction of hidden variable theories. The experiments described can be performed in an afternoon. © 2002 American Association of Physics Teachers.

[DOI: 10.1119/1.1498860]

I. INTRODUCTION

Entanglement of particles, an idea introduced into physics by the famous Einstein–Podolsky–Rosen GEDANKENEXPERIMENT,¹ is one of the most strikingly nonclassical features of quantum theory. In quantum mechanics, particles are called entangled if their state cannot be factored into single-particle states. The particles are, at least in their quantum description, inseparable. This inseparability is reflected in the behavior of the particles. For example, a pair of entangled photons can show strong polarization correlations even when each one by itself appears unpolarized. The standard Copenhagen interpretation of quantum measurement suggests that these correlations arise from *nonlocality* of the measuring process: a measurement on one particle instantly collapses the state of both particles, even if they are not near each other. Alternative theories, which contain no such nonlocal “action at a distance” effects, were considered by Bell.^{2,3} His Bell inequality showed that a very broad class of local theories disagreed with quantum mechanics about the degree of polarization correlation. Experimental tests have repeatedly found agreement with quantum mechanics and disagreed with this class of more intuitive, local theories.

Recent advances in optical technologies have reduced the cost of producing and detecting entangled particles, making this fascinating subject accessible to a wider audience. Here we describe experiments to demonstrate polarization entanglement and test a Bell inequality. To our knowledge, these are the first experiments of this sort designed for undergraduates. The new technologies which make the experiments practical at reasonable cost, the InGaN diode laser and the two-crystal geometry, were both introduced in 1999.^{4,5} In parallel with the experiments, we present a brief exposition of the concept of entanglement, from its introduction by Einstein through the insights of Bell to experimental tests.

II. HISTORY

Einstein remained troubled by the uncertainty principle long after quantum mechanics had been accepted by his contemporaries. Following a talk by Bohr in 1933, Einstein made a comment and introduced a

GEDANKENEXPERIMENT to question the uncertainty principle. As recounted by Rosenfeld, the argument went as follows:

“Suppose two particles are set in motion towards each other with the same, very large, momentum, and that they interact with each other for a very short time when they pass at known positions. Consider now an observer who gets hold of one of the particles, far away from the region of interaction, and measures its momentum; then, from the conditions of the experiment, he will obviously be able to deduce the momentum of the other particle. If, however, he chooses to measure the position of the first particle, he will be able to tell where the other particle is. This is a perfectly correct and straightforward deduction from the principles of quantum mechanics; but is it not very paradoxical? How can the final state of the second particle be influenced by a measurement performed on the first, after all physical interaction has ceased between them?”⁶

This last sentence assumes (as Bohr had insisted) that the act of getting information about a particle disturbs it, changing its state. Einstein realized that this information could be obtained by a measurement on a different particle, with the paradoxical implication that a measurement in one place influences a particle in another.

Two years after Bohr’s talk Einstein, Podolsky, and Rosen (EPR) published a mathematical version of the same idea.¹ The paper does not suggest the paradoxical action at a distance, indeed it assumes that such a thing is impossible. Rather, the paper was intended “to expose an essential imperfection of quantum theory. Any attribute of a physical system that can be accurately determined without disturbing the system, thus went the argument, is an ‘element of physical reality,’ and a description of the system can only be regarded as complete if it embodies all the elements of reality which can be attached to it. Now, the example of the two particles shows that the position and the momentum of a given particle can be obtained by appropriate measurements performed on another particle without disturbing the first, and are therefore elements of reality in the sense indicated.

Because quantum theory does not allow both to enter into the description of the state of the particle, such a description is incomplete.”⁶

EPR concluded their paper with a challenge of sorts: “While we have thus shown that the wave function does not provide a complete description of the physical reality, we left open the question of whether or not such a description exists. We believe, however, that such a theory is possible.”¹

The “EPR paradox,” although it did not seriously shake confidence in quantum mechanics, did bring to light some of its most astounding features. Much work has been done since then to understand the apparent paradox that EPR raised, including both the clarification of the issues involved and experimental tests.^{7–14} Soon after the EPR paper appeared, it became clear that the paradox was not limited to position/momentum states. The paradoxical features remain, but the math is simpler if we work with discrete variables such as particle spin or photon polarization.

III. A POLARIZATION-ENTANGLED STATE

Consider a quantum mechanical system consisting of two photons called, for historical reasons, the “signal” and “idler” photons. The photons are heading in different directions, and thus can be treated as distinguishable particles. We assume the photons have the polarization state

$$|\psi_{\text{EPR}}\rangle \equiv \frac{1}{\sqrt{2}}(|V\rangle_s|V\rangle_i + |H\rangle_s|H\rangle_i), \quad (1)$$

where $|V\rangle$ and $|H\rangle$ indicate vertical and horizontal polarizations, respectively, and the subscripts indicate signal or idler. This state cannot be factored into a simple product of signal and idler states: $|\psi_{\text{EPR}}\rangle \neq |A\rangle_s|B\rangle_i$ for any choice of $|A\rangle_s$ and $|B\rangle_i$. This nonfactorability means the state of one particle cannot be specified without making reference to the other particle. Such particles are said to be “entangled” and $|\psi_{\text{EPR}}\rangle$ is an entangled state.

If we measure the polarizations of signal and idler photons in the H, V basis, there are two possible outcomes: both vertical or both horizontal. Each occurs half of the time. We could instead measure the polarizations with polarizers rotated by an angle α . We use the rotated polarization basis

$$\begin{aligned} |V_\alpha\rangle &= \cos \alpha |V\rangle - \sin \alpha |H\rangle, \\ |H_\alpha\rangle &= \sin \alpha |V\rangle + \cos \alpha |H\rangle. \end{aligned} \quad (2)$$

Here $|V_\alpha\rangle$ describes a state with polarization rotated by α from the vertical, while $|H_\alpha\rangle$ is α from the horizontal. In this basis the state is

$$|\psi_{\text{EPR}}\rangle = \frac{1}{\sqrt{2}}(|V_\alpha\rangle_s|V_\alpha\rangle_i + |H_\alpha\rangle_s|H_\alpha\rangle_i). \quad (3)$$

Clearly, if we measure in this rotated basis, we obtain the same results: half the time both are $|V_\alpha\rangle$ and half of the time both are $|H_\alpha\rangle$. Knowing this, we can measure the signal polarization and infer with certainty the idler polarization. This is the situation EPR described, but we have used polarizations instead of position and momentum. Note that there is an uncertainty relationship between polarizations in different bases. Knowledge of a photon’s polarization in the V_{0°, H_{0° basis implies complete uncertainty of its polarization in the $V_{45^\circ}, H_{45^\circ}$ basis, for example.

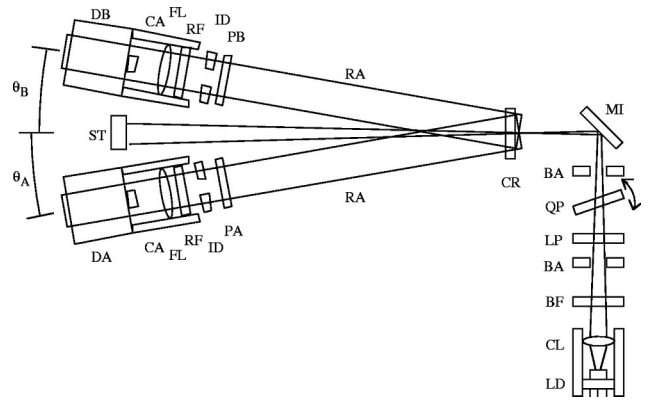

Fig. 1. Schematic of experimental setup, not to scale. Symbols: (LD) laser diode, (CL) collimating lens, (BF) blue filter, (BA) beam aperture, (LP) laser polarizer, (QP) quartz plate, (MI) mirror, (CR) downconversion crystals, (RA) rail, (PA) polarizer A, (PB) polarizer B, (ID) iris diaphragm, (RF) red filter, (FL) focusing lens, (CA) cage assembly, (DA) detector A, (DB) detector B, (ST) beam stop.

IV. SETUP

Figure 1 shows a schematic of our experimental setup to produce polarization-entangled photons. A 5-mW free-running InGaN diode laser produces a beam of violet (405 nm) photons which pass through a blue filter, a linear polarizer, and a birefringent plate before reaching a pair of beta barium borate (BBO) crystals. In the crystals, a small fraction of the laser photons spontaneously decay into pairs of photons by the process of spontaneous parametric downconversion (SPD).^{15–20} In a given decay the downconverted photons emerge at the same time and on opposite sides of the laser beam.

SPD can be understood as the time-reversed process of sum-frequency generation (SFG). In SFG, two beams of frequency ω_1 and ω_2 meet in a nonlinear crystal that lacks inversion symmetry. The crystal acts like a collection of ions in anharmonic potentials. When driven at both ω_1 and ω_2 , the ions oscillate with several frequency components including the sum frequency $\omega_1 + \omega_2$. Each ion radiates at this frequency (among others). The coherent addition of light from each ion in the crystal leads to constructive interference only for certain beam directions and certain polarizations. The condition for constructive interference is called the “phase matching” requirement: inside the crystal the wave vectors of the input beams must sum to that of the output beam.²¹ In SPD, the violet laser drives the crystal at the sum frequency and downconverted light at ω_1 and ω_2 is produced. SPD was first used to test a Bell inequality in 1988.^{22,23}

The detectors, two single-photon counting modules (SPCMs), are preceded by linear polarizers and red filters to block any scattered laser light. Even so, it is necessary to use coincidence detection to separate the downconverted photons from the background of other photons reaching the detectors. Because the photons of a downconverted pair are produced at the same time, they cause coincident, that is, nearly simultaneous, firings of the SPCMs. Coincidences are detected by a fast logic circuit and recorded by a personal computer (not shown in Fig. 1). The detection components (SPCMs, lenses and filters) are mounted on rails that pivot about a vertical axis passing through the crystals. This arrangement allows the detection of SPD photons at different angles with

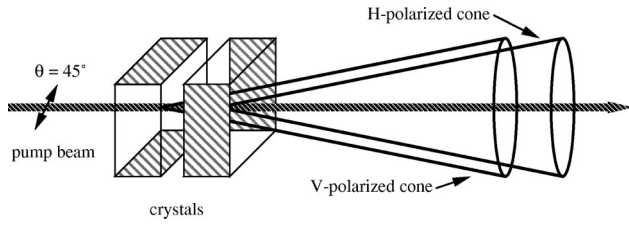

Fig. 2. Two-crystal downconversion source, not to scale. The crystals are 0.1 mm thick and in contact face-to-face, while the pump beam is approximately 1 mm in diameter. Thus the cones of downconverted light from the two crystals overlap almost completely.

minimal realignment. The setup is described in detail in the preceding article.²⁴ The rails were positioned at $\theta_A = \theta_B = 2.5^\circ$ and the focusing lenses adjusted for maximum singles rates. With the irises fully open and polarizers both set to vertical, more than 300 coincidence counts per second were observed.

V. POLARIZATIONS

Our BBO crystals are cut for type I phase matching, which means that the signal and idler photons emerge with the same polarization, which is orthogonal to that of the pump photon. Each crystal can only support downconversion of one pump polarization. The other polarization passes through the crystal unchanged. We use two crystals, one rotated 90° from the other, so that either pump polarization can downconvert according to the rules

$$|V\rangle_p \rightarrow |H\rangle_s |H\rangle_i, \quad (4a)$$

$$|H\rangle_p \rightarrow \exp[i\Delta] |V\rangle_s |V\rangle_i, \quad (4b)$$

where Δ is a phase due to dispersion and birefringence in the crystals. The geometry is shown schematically in Fig. 2.

To create an entangled state, we first linearly polarize the laser beam at an angle θ_l from the vertical and then shift the phase of one polarization component by ϕ_l with the birefringent quartz plate. The laser photons (pump photons) are then in the state

$$|\psi_{\text{pump}}\rangle = \cos \theta_l |V\rangle_p + \exp[i\phi_l] \sin \theta_l |H\rangle_p, \quad (5)$$

when they reach the crystals. The downconverted photons emerge in the state

$$|\psi_{\text{DC}}\rangle = \cos \theta_l |H\rangle_s |H\rangle_i + \exp[i\phi] \sin \theta_l |V\rangle_s |V\rangle_i, \quad (6)$$

where $\phi \equiv \phi_l + \Delta$ is the total phase difference of the two polarization components.²⁵

By placing polarizers rotated to angles α and β in the signal and idler paths, respectively, we measure the polarization of the downconverted photons. For a pair produced in the state $|\psi_{\text{DC}}\rangle$, the probability of coincidence detection is

$$P_{VV}(\alpha, \beta) = |\langle V_\alpha | \langle V_\beta | \psi_{\text{DC}} \rangle|^2. \quad (7)$$

The VV subscripts on P indicate the measurement outcome $V_\alpha V_\beta$, both photons vertical in the bases of their respective polarizers. More generally, for any pair of polarizer angles α , β , there are four possible outcomes, $V_\alpha V_\beta$, $V_\alpha H_\beta$, $H_\alpha V_\beta$, and $H_\alpha H_\beta$, indicated by VV , VH , HV , and HH , respectively. Using the basis of Eq. (2), we find

$$P_{VV}(\alpha, \beta) = |\sin \alpha \sin \beta \cos \theta_l + \exp[i\phi] \cos \alpha \cos \beta \sin \theta_l|^2, \quad (8)$$

or

$$P_{VV}(\alpha, \beta) = \sin^2 \alpha \sin^2 \beta \cos^2 \theta_l + \cos^2 \alpha \cos^2 \beta \sin^2 \theta_l + \frac{1}{4} \sin 2\alpha \sin 2\beta \sin 2\theta_l \cos \phi. \quad (9)$$

A special case occurs when $|\psi_{\text{DC}}\rangle = |\psi_{\text{EPR}}\rangle$, that is, when $\theta_l = \pi/4$ and $\phi = 0$. In this case

$$P_{VV}(\alpha, \beta) = \frac{1}{2} \cos^2(\beta - \alpha), \quad (10)$$

which depends only on the *relative* angle $\beta - \alpha$.

The last term in Eq. (9) is a cross term that accounts for the interference between the H, H and V, V parts of the state. The ϕ in this term is, through its dependence on Δ , a complicated function of pump photon wavelength, signal photon wavelength and angle, as well as crystal characteristics. Because the laser has a finite linewidth and we collect photons over a finite solid angle and wavelength range, we collect a range of ϕ . To account for this, we replace $\cos \phi$ by its average $\langle \cos \phi \rangle \equiv \cos \phi_m$ and write

$$P_{VV}(\alpha, \beta) = \sin^2 \alpha \sin^2 \beta \cos^2 \theta_l + \cos^2 \alpha \cos^2 \beta \sin^2 \theta_l + \frac{1}{4} \sin 2\alpha \sin 2\beta \sin 2\theta_l \cos \phi_m. \quad (11)$$

In our experiment we choose a fixed interval T of data acquisition (typically in the range 0.5–15 s) and record the number of coincidences $N(\alpha, \beta)$ during that interval. Assuming a constant flux of photon pairs, the number collected will be

$$N(\alpha, \beta) = A(\sin^2 \alpha \sin^2 \beta \cos^2 \theta_l + \cos^2 \alpha \cos^2 \beta \sin^2 \theta_l + \frac{1}{4} \sin 2\alpha \sin 2\beta \sin 2\theta_l \cos \phi_m) + C, \quad (12)$$

where A is the total number of entangled pairs produced, and C is an offset to account for imperfections in the polarizers and alignment of the crystals. This offset is necessary to account for the fact that some coincidences are observed even when the polarizers are set to $\alpha = 0$, $\beta = 90^\circ$.

VI. TUNING THE STATE

To create the state $|\psi_{\text{EPR}}\rangle$ or something close to it, we adjust the parameters that determine the laser polarization. First we adjust θ_l to equalize the coincidence counts $N(0^\circ, 0^\circ)$ and $N(90^\circ, 90^\circ)$. Next we set ϕ_l by rotating the quartz plate about a vertical axis to maximize $N(45^\circ, 45^\circ)$. When performing these optimizations, we typically collect a few hundred photons per point, which requires an acquisition window of a few seconds.

A rough idea of the purity of the entangled state can be found by measuring $N(0^\circ, 0^\circ)$, $N(90^\circ, 90^\circ)$, $N(45^\circ, 45^\circ)$, and $N(0^\circ, 90^\circ)$. Using the model of Eq. (12), we find

$$C = N(0^\circ, 90^\circ), \quad (13)$$

$$A = N(0^\circ, 0^\circ) + N(90^\circ, 90^\circ) - 2C, \quad (14)$$

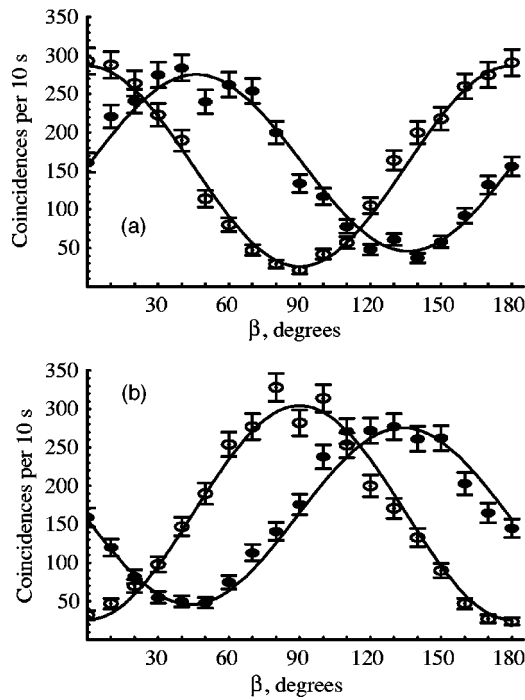

Fig. 3. Experimental polarization correlations. (a) $\alpha=0^\circ$ (open circles) and $\alpha=45^\circ$ (closed circles). (b) $\alpha=90^\circ$ (open circles) and $\alpha=135^\circ$ (closed circles). Error bars indicate plus/minus one standard deviation statistical uncertainty. The curves are a fit to Eq. (12).

$$\tan^2 \theta_l = \frac{N(90^\circ, 90^\circ) - C}{N(0^\circ, 0^\circ) - C}, \quad (15)$$

$$\cos \phi_m = \frac{1}{\sin 2\theta_l} \left(4 \frac{N(45^\circ, 45^\circ) - C}{A} - 1 \right). \quad (16)$$

After optimizing θ_l and ϕ_l we find in a typical acquisition with $T=10$ s that $N(0,0)=293$, $N(90,90)=307$, $N(0,90)=22$, and $N(45,45)=286$. These results give $C=22$, $A=556$, $\theta_l=46^\circ$, and $\phi_m=26^\circ$. More extensive data are shown in Fig. 3 along with a fit to Eq. (12). The best fit parameters, $C=31$, $A=539$, $\theta_l=46^\circ$, and $\phi_m=26^\circ$ are in good agreement with the rough estimates made with just four points.

Careful inspection of Fig. 3 shows that the theoretical curve would fit better if it were shifted slightly to the left. In other words, it appears as if our polarizer angle β is consistently off by a few degrees. This could be due to imperfect positioning of the crystals, polarizers, or detector rails. In realignments of the lenses and rails this shift varied from 3° (shown) to 8° , but could not be completely eliminated. Although we did not find it necessary to do so, a shift of this sort could be compensated by appropriately counter-shifting the settings of β at which measurements are taken. This compensation has no effect on any of the procedures described below.

VII. QUANTUM MEASUREMENT AND ENTANGLED PARTICLES

In his comment on Bohr's lecture, Einstein noted that quantum mechanics allows a measurement of one particle to influence the state of another.⁶ To illustrate this influence for polarizations, we consider again the state $|\psi_{\text{EPR}}\rangle$ of Eq. (3).

If the signal photon is measured with a polarizer set to α , the result will be H_α or V_α , each occurring half the time. In the usual Copenhagen interpretation the state has collapsed at the moment of measurement from $|\psi_{\text{EPR}}\rangle$ to either $|V_\alpha\rangle_s |V_\alpha\rangle_i$ or $|H_\alpha\rangle_s |H_\alpha\rangle_i$. But the mere choice of α does not determine the state of the idler photon; it is the (random) outcome of the measurement on the signal photon that decides whether the idler ends up as $|V_\alpha\rangle_i$ or $|H_\alpha\rangle_i$. Despite the randomness, the choice of α clearly has an effect on the state of the idler photon: it gives it a definite polarization in the $|V_\alpha\rangle_i, |H_\alpha\rangle_i$ basis, which it did not have before the measurement.

The process described above is nonlocal: the state changes instantly even though the particles could be separated by a large distance. We are accustomed to saying that this sort of instantaneous action at a distance is forbidden by relativity, or that it leads to paradoxes about sending messages to earlier times. In this case, though, the randomness of quantum mechanics prevents any paradoxes from arising. The measurement on the signal photon, whatever its effect on the state of the idler photon, cannot be observed in measurements on the idler photon alone. After the signal photon is measured, the idler is equally likely to be V_α or H_α . A measurement of its polarization, at any angle β , finds V_β with probability

$$P_V(\beta) = \frac{1}{2} |\langle V_\beta | V_\alpha \rangle|^2 + \frac{1}{2} |\langle V_\beta | H_\alpha \rangle|^2 \quad (17a)$$

$$= \frac{1}{2} [\cos^2(\beta - \alpha) + \sin^2(\beta - \alpha)] \quad (17b)$$

$$= \frac{1}{2}. \quad (17c)$$

This measurement gives no information about the choice of α . It is also the probability we would find if the signal photon had *not* been measured.

Thus quantum mechanics (in the Copenhagen interpretation) is consistent with relativistic causality. It achieves that consistency by balancing two improbable claims: the particles influence each other nonlocally, and the randomness of nature prevents us from sending messages that way. A comment by Einstein succinctly captures the oddness of this situation. In a 1947 letter to Max Born he objected that quantum mechanics entails "spooky actions at a distance."²⁶

VIII. A LOCAL REALISTIC HIDDEN VARIABLE THEORY

Einstein believed that a theory could be found to replace quantum mechanics, one which was complete and contained only local interactions. Here we describe such a theory, a "local realistic hidden variable theory" (HVT). The name will become clear shortly. These were first considered by Bell, although our presentation most closely follows that of Aspect.^{2,3,14} We emphasize that this theory is not a modification of quantum mechanics (in fact it is closer to classical mechanics). Only the predictions of the two theories will be similar.

In this HVT, each photon has a polarization angle λ , but this polarization does not behave like polarization in quantum mechanics. When a photon meets a polarizer set to an angle γ , it will always register as V_γ if λ is closer to γ than to $\gamma + \pi/2$, that is,

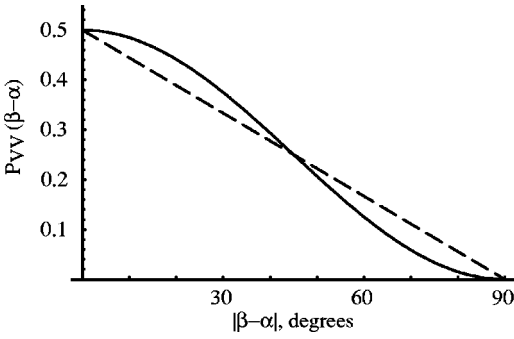

Fig. 4. Predicted polarization correlations for a quantum mechanical entangled state (solid curve) and a hidden-variable theory (dashed line).

$$P_V^{(\text{HVT})}(\gamma, \lambda) = \begin{cases} 1 & |\gamma - \lambda| \leq \pi/4 \\ 1 & |\gamma - \lambda| > 3\pi/4 \\ 0, & \text{otherwise.} \end{cases} \quad (18)$$

In each pair, the signal and idler photon have the same polarization $\lambda_s = \lambda_i = \lambda$. As successive pairs are produced, λ changes in an unpredictable manner that uniformly covers the whole range of possible polarizations.

The quantity λ is the “hidden variable,” a piece of information that is absent from quantum mechanics. HVTs do not have the spooky features of quantum mechanics. The theory is *local*: measurement outcomes are determined by features of objects present at the site of measurement. Any measurement on the signal (idler) photon is determined by λ_s and α (λ_i and β). The theory is also *realistic*: All measurable quantities have definite values, independent of our knowledge of them. Furthermore, the theory specifies all of these values (for a given λ), so it is *complete* in Einstein’s sense of the word. Finally, there is no requirement that λ be random; it could be that λ is changing in a deterministic way that remains to be discovered.

To compare this theory to quantum mechanics, we need a prediction for the coincidence probability $P_{VV}^{(\text{HVT})}(\alpha, \beta)$. A coincidence occurs when λ is in a range such that both α and β are close to λ . The probability of this coincidence is

$$\begin{aligned} P_{VV}^{(\text{HVT})}(\alpha, \beta) &= \frac{1}{\pi} \int_0^\pi P_V^{(\text{HVT})}(\alpha, \lambda) P_V^{(\text{HVT})}(\beta, \lambda) d\lambda \\ &= \frac{1}{2} - \frac{|\beta - \alpha|}{\pi}. \end{aligned} \quad (19)$$

This function and the corresponding quantum mechanical probability from Eq. (10) are plotted in Fig. 4. The predictions are fairly similar. Where they disagree quantum mechanics predicts stronger correlations (or stronger anticorrelations) than the HVT.

Our HVT is very simple, and yet it agrees pretty well with quantum mechanics. We might hope that some slight modification would bring it into perfect agreement. In 1964 Bell showed that this is impossible. He derived an inequality that all HVTs obey, but which quantum mechanics violates. We will use a slightly different inequality, one due to Clauser, Horne, Shimony, and Holt.²⁷ It is nonetheless called a Bell inequality.

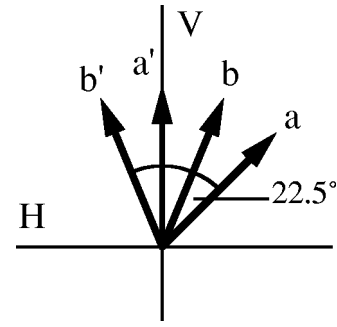

Fig. 5. Polarizer angles for maximal $S^{(\text{QM})}$.

The Bell inequality constrains the degree of polarization correlation under measurements at different polarizer angles. The proof involves two measures of correlation. The first is

$$\begin{aligned} E(\alpha, \beta) &\equiv P_{VV}(\alpha, \beta) + P_{HH}(\alpha, \beta) - P_{VH}(\alpha, \beta) \\ &\quad - P_{HV}(\alpha, \beta). \end{aligned} \quad (20)$$

The measure $E(\alpha, \beta)$ incorporates all possible measurement outcomes and varies from $+1$ when the polarizations always agree to -1 when they always disagree. The second measure is

$$S \equiv E(a, b) - E(a, b') + E(a', b) + E(a', b'), \quad (21)$$

where a, a', b, b' are four different polarizer angles. S does not have a clear physical meaning. Its importance comes from the fact that

$$|S| \leq 2 \quad (22)$$

for any HVT and arbitrary a, a', b, b' . This is proved in the Appendix, and was first shown by Clauser, Horne, Shimony, and Holt.²⁷ Quantum mechanics can, for certain settings, violate this inequality. If we choose the polarizer angles, $a = -45^\circ$, $a' = 0^\circ$, $b = 22.5^\circ$, and $b' = 22.5^\circ$ as shown in Fig. 5, then, using Eqs. (10), (20), and (21), we find

$$S^{(\text{QM})} = 2\sqrt{2}. \quad (23)$$

This result is specific to the state $|\psi_{\text{EPR}}\rangle$. Other states give lower values of S . It is interesting to note that for these angles our simple HVT gives

$$S^{(\text{HVT})} = 2. \quad (24)$$

The simple HVT mimics quantum mechanics as well as possible in light of Eq. (22).

The Bell inequality shows that no theory which is both local and realistic (or complete in the EPR sense) will ever agree with quantum mechanics. There remains the question of whether *nature* agrees with quantum mechanics or the Bell inequality. Because we have a source that produces photons in the state $|\psi_{\text{EPR}}\rangle$, or something close to it, we can measure S . If we find $S > 2$, we will have violated the Bell inequality and thus disproved all HVTs. If we find $S \leq 2$, no conclusion can be drawn; both quantum mechanics and HVTs are consistent with this result.

IX. BELL INEQUALITY VIOLATION

To find the probabilities P that make up E , we need four values of N , specifically $P_{VV}(\alpha, \beta) = N(\alpha, \beta)/N_{\text{tot}}$, $P_{VH}(\alpha, \beta) = N(\alpha, \beta_\perp)/N_{\text{tot}}$, $P_{HV}(\alpha, \beta) = N(\alpha_\perp, \beta)/N_{\text{tot}}$,

Table I. Singles (N_A, N_B) and coincidence (N) detections as a function of polarizer angles α, β . The acquisition window was $T=15$ s, and the irises were fully open. Also shown are accidental coincidences ($N_{ac} = \tau N_A N_B / T$) assuming a coincidence window of $\tau=25$ ns.

α	β	N_A	N_B	N	N_{ac}
-45°	-22.5°	84 525	80 356	842	10.0
-45°	22.5°	84 607	82 853	212	10.3
-45°	67.5°	83 874	82 179	302	10.1
-45°	112.5°	83 769	77 720	836	9.5
0°	-22.5°	87 015	80 948	891	10.3
0°	22.5°	86 674	83 187	869	10.6
0°	67.5°	87 086	81 846	173	10.5
0°	112.5°	86 745	77 700	261	9.9
45°	-22.5°	87 782	80 385	255	10.3
45°	22.5°	87 932	83 265	830	10.7
45°	67.5°	87 794	81 824	814	10.5
45°	112.5°	88 023	77 862	221	10.1
90°	-22.5°	88 416	80 941	170	10.5
90°	22.5°	88 285	82 924	259	10.7
90°	67.5°	88 383	81 435	969	10.6
90°	112.5°	88 226	77 805	846	10.1

and $P_{HH}(\alpha, \beta) = N(\alpha_{\perp}, \beta_{\perp}) / N_{tot}$, where $N_{tot} = N(\alpha, \beta) + N(\alpha_{\perp}, \beta) + N(\alpha, \beta_{\perp}) + N(\alpha_{\perp}, \beta_{\perp})$ is the total number of pairs detected and $\alpha_{\perp}, \beta_{\perp}$ are the polarizer settings $\alpha + 90^\circ, \beta + 90^\circ$. Thus measuring E requires counting coincidences for equal intervals with the polarizers set four different ways. In measuring the probabilities this way we make the assumption that the flux of photon pairs is the same in each interval and does not depend on the polarizer settings. These assumptions are reasonable, but they do create a loophole in our experimental test. A HVT, along with the hypothesis that the polarizer settings influence the rate of downconversion, could account for any results we observe. There is no evidence to support such a hypothesis. Nevertheless, for someone convinced of locality and realism, an ad hoc hypothesis of this sort may be more plausible than the alternative.²⁸

A typical set of measurements is shown in Table I. Also shown is the computed number of accidental coincidences, the average number of times that photons from two different downconversion events will arrive, purely by happenstance, within the coincidence interval τ of each other. This background is small, nearly constant, and acts to decrease $|S|$. A finding of $|S| > 2$ thus cannot be an artifact of the accidental background.

The quantity $E(\alpha, \beta)$ requires four N measurements,

$$E(\alpha, \beta) = \frac{N(\alpha, \beta) + N(\alpha_{\perp}, \beta_{\perp}) - N(\alpha, \beta_{\perp}) - N(\alpha_{\perp}, \beta)}{N(\alpha, \beta) + N(\alpha_{\perp}, \beta_{\perp}) + N(\alpha, \beta_{\perp}) + N(\alpha_{\perp}, \beta)}, \quad (25)$$

and $S \equiv E(a, b) - E(a, b') + E(a', b) + E(a', b')$ requires sixteen.

From these we find $S = 2.307 > 2$. We have violated the Bell inequality. To be sure of the result, we compute its statistical uncertainty. The uncertainty of the i th measurement N_i is $\sigma_{N_i} = \sqrt{N_i}$, and the uncertainty of the quantity S is

$$\sigma_S = \sqrt{\sum_{i=1}^{16} \left(\sigma_{N_i} \frac{\partial S}{\partial N_i} \right)^2} = \sqrt{\sum_{i=1}^{16} N_i \left(\frac{\partial S}{\partial N_i} \right)^2}. \quad (26)$$

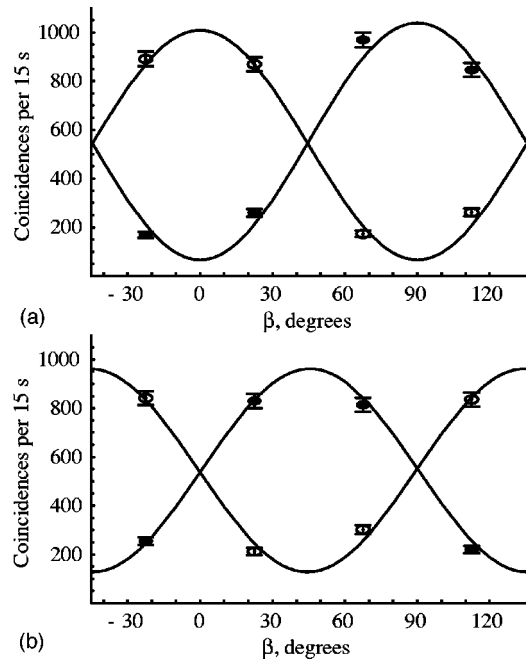

Fig. 6. Typical coincidence counts for the Bell inequality test. (a) Open and closed circles show $\alpha=0^\circ, 90^\circ$, respectively. (b) Open and closed circles show $\alpha=45^\circ, 135^\circ$, respectively. Error bars indicate plus or minus one standard deviation statistical uncertainty. The curves are a fit to Eq. (12).

This sum contains a very large number of terms and can be evaluated by computer to yield $\sigma_S = 0.035$. Hence,

$$S = 2.307 \pm 0.035, \quad (27)$$

a violation of the Bell inequality by more than eight standard deviations. This result conclusively eliminates the HVTs, and is consistent with quantum mechanics. Figure 6 shows a comparison of these data to Eq. (12).

X. INTERPRETATION

The meaning of a Bell inequality violation is a topic for philosophy, not experimental physics. A good starting point for readings in the philosophy of entanglement is Ref. 29. Still, we will make a few comments. These should be understood as our (perhaps idiosyncratic) interpretation, rather than any consensus on the part of philosophers or physicists.

In the HVTs every measurement outcome can be explained in terms of an underlying reality in which all interactions are local. In our example, all possible outcomes are explained by the polarizations λ_s, λ_i of the photons, and the measurement of one does not change the other. In light of the Bell inequality and our experimental findings, this sort of explanation (not just our particular example) is impossible. We may be able to retain one of our assumptions, realism or locality, but not both. Any realistic explanation must therefore include nonlocal interactions, for example λ_s could change in response to a measurement performed on the idler photon. This explanation seems to be preferred by most researchers, and an experimental Bell inequality violation is sometimes described as a “disproof of the principle of locality.”³⁰ Another possibility exists: one could instead give up the realism assumption and say that there is no underlying reality to explain the observations, just statistical regularities

relating measurement outcomes. If one of the goals of physics is to explain the hidden workings of nature, accepting this position is profoundly disappointing.

It is interesting to note that a similar dilemma concerns the interpretation of the state vector in quantum mechanics. In the Copenhagen interpretation, the state vector of a pair of entangled particles changes instantaneously upon measurement. Furthermore, it can change in response to a measurement made on either particle, that is, to measurements made in different places. If the state vector is considered to be a real thing, then state vector collapse is an example of instantaneous action at a distance. But the state vector could be viewed differently, as nothing more than a calculational device. After all, there is no way to measure the state vector, only probabilities derived from it. As shown in Eq. (17), the probability for any single-particle outcome behaves locally. In this view, there is no action at a distance, but there is also no answer to the question of what really is going on.

XI. CONCLUSION

Using technology within reach of an undergraduate laboratory, we have created polarization-entangled photon pairs. We have used these to illustrate the Einstein–Podolsky–Rosen paradox and quantum nonlocality. The source of entangled photons uses a violet diode laser and a two-crystal geometry and can be tuned to produce an approximation of the state $|\psi_{\text{EPR}}\rangle \equiv (|V\rangle_s |V\rangle_i + |H\rangle_s |H\rangle_i) / \sqrt{2}$. Polarization-sensitive coincidence measurements clearly show the polarization correlations of this state, analogous to the position-momentum correlations discussed by Einstein, Podolsky, and Rosen.¹ Using this setup we have shown a Bell inequality violation of more than eight standard deviations, in clear contradiction of local realistic hidden variable theories.

ACKNOWLEDGMENTS

We thank Paul Kwiat and David Griffiths for extensive and helpful comments. This work was supported by Reed College and Grant No. DUE-0088605 from the National Science Foundation.

APPENDIX: PROOF OF THE CHSH BELL INEQUALITY

For any HVT, the distribution of the hidden variable λ is described by a function $\rho(\lambda)$, where

$$\rho(\lambda) \geq 0, \quad (\text{A1})$$

and

$$\int \rho(\lambda) d\lambda = 1. \quad (\text{A2})$$

The assumptions of locality and realism are embodied in the following: It is assumed that for the signal photon the outcome of a measurement is determined completely by λ and the measurement angle α . These outcomes are specified by the function $A(\lambda, \alpha)$, which can take on the values $+1$ for detection as V_α and -1 for detection as H_α . Similarly, a function $B(\lambda, \beta)$ describes the outcomes for the idler photon as $+1$ for V_β and -1 for H_β . A HVT could specify the functions ρ , A and B .

The probability of a particular outcome, averaged over an ensemble of photon pairs, is given by an integral. In particular,

$$P_{VV}(\alpha, \beta) = \int \frac{1+A(\lambda, \alpha)}{2} \frac{1+B(\lambda, \beta)}{2} \rho(\lambda) d\lambda, \quad (\text{A3a})$$

$$P_{VH}(\alpha, \beta) = \int \frac{1+A(\lambda, \alpha)}{2} \frac{1-B(\lambda, \beta)}{2} \rho(\lambda) d\lambda, \quad (\text{A3b})$$

$$P_{HV}(\alpha, \beta) = \int \frac{1-A(\lambda, \alpha)}{2} \frac{1+B(\lambda, \beta)}{2} \rho(\lambda) d\lambda, \quad (\text{A3c})$$

$$P_{HH}(\alpha, \beta) = \int \frac{1-A(\lambda, \alpha)}{2} \frac{1-B(\lambda, \beta)}{2} \rho(\lambda) d\lambda, \quad (\text{A3d})$$

are the probabilities of finding $V_\alpha V_\beta$, $V_\alpha H_\beta$, $H_\alpha V_\beta$, and $H_\alpha H_\beta$, respectively.

It is easy to show that E , given in Eq. (20), is

$$E(\alpha, \beta) = \int A(\lambda, \alpha) B(\lambda, \beta) \rho(\lambda) d\lambda. \quad (\text{A4})$$

We define the quantity s , which describes the polarization correlation in a single pair of particles:

$$\begin{aligned} s &\equiv A(\lambda, a)B(\lambda, b) - A(\lambda, a)B(\lambda, b') + A(\lambda, a')B(\lambda, b) \\ &\quad + A(\lambda, a')B(\lambda, b') \\ &= A(\lambda, a)[B(\lambda, b) - B(\lambda, b')] \\ &\quad + A(\lambda, a')[B(\lambda, b) + B(\lambda, b')], \end{aligned} \quad (\text{A5})$$

where a , a' , b , b' are four angles as in Eq. (21). Note that s can only take on the values ± 2 . The average of s over an ensemble of pairs is

$$\begin{aligned} \langle s \rangle &= \int s(\lambda, a, a', b, b') \rho(\lambda) d\lambda \\ &= E(a, b) - E(a, b') + E(a', b) + E(a', b') \\ &= S(a, a', b, b'). \end{aligned} \quad (\text{A6})$$

Because s can only take on the values ± 2 , its average S must satisfy $-2 \leq S \leq +2$, which is the Bell inequality given in Eq. (22).

^{a)}Electronic mail: morgan.mitchell@reed.edu

¹A. Einstein, B. Podolsky, and N. Rosen, "Can quantum-mechanical description of physical reality be considered complete?" *Phys. Rev.* **47**, 777–780 (1935).

²J. S. Bell, "On the Einstein–Podolsky–Rosen paradox," *Physics* (Long Island City, N.Y.) **1**, 195–200 (1964). This article is reprinted in Ref. 31.

³J. S. Bell, *Speakable and Unsayable in Quantum Mechanics: Collected Papers on Quantum Philosophy* (Cambridge U.P., Cambridge, 1993).

⁴<http://www.nichia.co.jp>. Home page of Nichia Corporation, manufacturer of InGaN laser diodes.

⁵P. G. Kwiat, E. Waks, A. G. White, I. Applebaum, and P. H. Eberhard, "Ultrabright source of polarization-entangled photons," *Phys. Rev. A* **60** (2), R773–R776 (1999).

⁶L. Rosenfeld, "Niels Bohr in the thirties: consolidation and extension of the conception of complementarity," in *Niels Bohr: His Life and Work as Seen by his Friends and Colleagues*, edited by S. Rozental (North-Holland, Amsterdam, 1967).

⁷N. Bohr, "Can quantum-mechanical description of physical reality be considered complete?" *Phys. Rev.* **48**, 696–702 (1935).

⁸J. F. Clauser and M. A. Horne, "Experimental consequences of objective local theories," *Phys. Rev. D* **10**, 526–535 (1974).

⁹A. Peres, "Unperformed experiments have no results," *Am. J. Phys.* **46**, 745–747 (1978).

- ¹⁰N. D. Mermin, "Is the moon there when nobody looks? Reality and the quantum theory," *Phys. Today* **38** (4), 38–47 (1985).
- ¹¹J. F. Clauser, "Experimental investigation of a polarization correlation anomaly," *Phys. Rev. Lett.* **36** (5), 1223–1226 (1976).
- ¹²J. F. Clauser, "Measurement of the circular-polarization correlation in photons from an atomic cascade," *Nuovo Cimento Soc. Ital. Fis., B* **338** (2), 740–746 (1976).
- ¹³J. F. Clauser and A. Shimony, "Bell's theorem—experimental tests and implications," *Rep. Prog. Phys.* **41**, 1881–1927 (1978).
- ¹⁴A. Aspect and P. Grangier, "Experiments on Einstein–Podolsky–Rosen-type correlations with pairs of visible photons," edited by R. Penrose and C. J. Isham, *Quantum Concepts in Space and Time* (Oxford U.P., 1986), pp. 1–44.
- ¹⁵W. H. Louisell, A. Yariv, and A. E. Siegman, "Quantum fluctuations and noise in parametric processes I," *Phys. Rev.* **124** (6), 1646–1654 (1961).
- ¹⁶B. R. Mollow, "Quantum statistics of coupled oscillator systems," *Phys. Rev.* **162** (5), 1256–1273 (1967).
- ¹⁷T. G. Giallorenzi and C. L. Tang, "Quantum theory of spontaneous parametric scattering of intense light," *Phys. Rev.* **166** (2), 225–233 (1968).
- ¹⁸B. Ya. Zel'dovich and D. N. Klyshko, "Field statistics in parametric luminescence," *JETP Lett.* **9** (1), 40–43 (1969).
- ¹⁹C. K. Hong and L. Mandel, "Theory of parametric frequency down conversion of light," *Phys. Rev. A* **31** (4), 2409–2418 (1985).
- ²⁰P. Hariharan and B. Sanders, "Quantum phenomena in optical interferometry," *Prog. Opt.* **36**, 49–128 (1996).
- ²¹R. W. Boyd, *Nonlinear Optics* (Academic, Boston, MA, 1992).
- ²²Z. Y. Ou and L. Mandel, "Violation of Bell's inequality and classical probability in a two-photon correlation experiment," *Phys. Rev. Lett.* **61** (1), 50–53 (1988).
- ²³Y. H. Shih and C. O. Alley, "New type of Einstein–Podolsky–Rosen–Bohm experiment using pairs of light quanta produced by optical parametric down conversion," *Phys. Rev. Lett.* **61** (26), 2921–2924 (1988).
- ²⁴D. Dehlinger and M. W. Mitchell, "Entangled photon apparatus for the undergraduate laboratory," *Am. J. Phys.* **70**, 898 (2002).
- ²⁵This state is an entangled state and is already quite adjustable. Further modifications can be made with ordinary optical components. For example, if $\theta_i = \pi/4$ and $\phi = \pi$, then a half-wave plate in the signal beam could be used to switch the signal polarization $|H\rangle_s \leftrightarrow |V\rangle_s$ to produce $|\psi'_{DC}\rangle = (|V\rangle_s |H\rangle_i - |H\rangle_s |V\rangle_i) / \sqrt{2}$. This polarization state is analogous to the singlet state for two spin-1/2 particles $|\psi_{\text{singlet}}\rangle = (|\uparrow\rangle|\downarrow\rangle - |\downarrow\rangle|\uparrow\rangle) / \sqrt{2}$.
- ²⁶*The Born–Einstein Letters: Correspondence between Albert Einstein and Max and Hedwig Born from 1916–1955*, with commentaries by Max Born (Walker, New York, 1971).
- ²⁷J. F. Clauser, M. A. Horne, A. Shimony, and R. A. Holt, "Proposed experiment to test local hidden-variable theories," *Phys. Rev. Lett.* **23** (15), 880–884 (1969).
- ²⁸A full discussion of loopholes in experimental tests of nonlocality is beyond the scope of this paper. Several other loopholes have been identified, for example the "timing loophole:" Given sufficient time, something could travel at a subluminal velocity from one polarizer to another and influence the measurement outcome at that other polarizer. This could explain any observed correlations, and in a purely local way. Experiments with rapidly changing polarizers have been performed to close this loophole (Refs. 32–34). Another important loophole that has been tested is the "detection loophole" (Refs. 25 and 36). To date, no single experiment has closed all loopholes. Thus HVTs have not been disproven, but the hypotheses required to save them have become highly implausible. See also Refs. 37–40.
- ²⁹M. Redhead, *Incompleteness, Nonlocality, and Realism: A Prolegomenon to the Philosophy of Quantum Mechanics* (Oxford U.P., Oxford, 1987).
- ³⁰L. Smolin, *The Life of the Cosmos* (Oxford U.P., Oxford, 1997), p. 253.
- ³¹J. A. Wheeler and W. H. Zurek, *Quantum Theory and Measurement* (Princeton U.P., Princeton, NJ, 1983).
- ³²A. Aspect, P. Grangier, and G. Roger, "Experimental realization of Einstein–Podolsky–Rosen–Bohm Gedankenexperiment—a new violation of Bell inequalities," *Phys. Rev. Lett.* **49** (2), 91–94 (1982).
- ³³A. Aspect, J. Dalibard, and G. Roger, "Experimental test of Bell inequalities using time-varying analyzers," *Phys. Rev. Lett.* **49** (25), 1804–1807 (1982).
- ³⁴G. Weihs, T. Jennewein, C. Simon, H. Weinfurter, and A. Zeilinger, "Violation of Bell's inequality under strict Einstein locality conditions," *Phys. Rev. Lett.* **81** (23), 5039–43 (1998).
- ³⁵N. Gisin and B. Gisin, "A local hidden variable model of quantum correlation exploiting the detection loophole," *Phys. Lett. A* **260** (5), 323–327 (1999).
- ³⁶M. A. Howe, D. Kielpinski, V. Meyer, C. A. Sackett, W. M. Itano, C. Monroe, and D. J. Wineland, "Experimental violation of a Bell's inequality with efficient detection," *Nature (London)* **409**, 791–794 (2001).
- ³⁷E. Santos, "Critical analysis of the empirical tests of local hidden-variable theories," *Phys. Rev. A* **46** (7), 3646–3656 (1992).
- ³⁸P. G. Kwiat, P. H. Eberhard, A. M. Steinberg, and R. Y. Chiao, "Proposal for a loophole-free Bell inequality experiment," *Phys. Rev. A* **49** (5), 3209–3220 (1994).
- ³⁹E. S. Fry, T. Walther, and S. F. Li, "Proposal for a loophole-free test of the Bell inequalities," *Phys. Rev. A* **52** (6), 4381–4395 (1995).
- ⁴⁰S. F. Huelga, M. Ferrero, and E. Santos, "Loophole-free test of the Bell inequality," *Phys. Rev. A* **51** (6), 5008–5011 (1995).