

Errata

Title & Document Type: 8011A Pulse Generator, Operation & Service Manual

Manual Part Number: 08011-90004

Revision Date: 1990

HP References in this Manual

This manual may contain references to HP or Hewlett-Packard. Please note that Hewlett-Packard's former test and measurement, semiconductor products and chemical analysis businesses are now part of Agilent Technologies. We have made no changes to this manual copy. The HP XXXX referred to in this document is now the Agilent XXXX. For example, model number HP8648A is now model number Agilent 8648A.

About this Manual

We've added this manual to the Agilent website in an effort to help you support your product. This manual provides the best information we could find. It may be incomplete or contain dated information, and the scan quality may not be ideal. If we find a better copy in the future, we will add it to the Agilent website.

Support for Your Product

Agilent no longer sells or supports this product. You will find any other available product information on the Agilent Test & Measurement website:

www.tm.agilent.com

Search for the model number of this product, and the resulting product page will guide you to any available information. Our service centers may be able to perform calibration if no repair parts are needed, but no other support from Agilent is available.

8011A PULSE GENERATOR

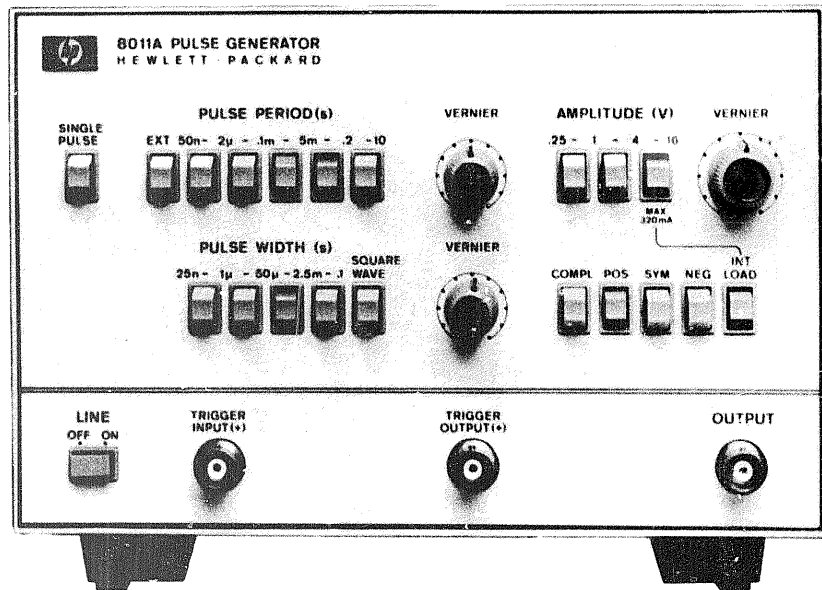

HEWLETT  PACKARD

CERTIFICATION

The Hewlett-Packard Company certifies that this instrument was thoroughly tested and inspected and found to meet its published specifications when it was shipped from the factory. The Hewlett-Packard Company further certifies that its calibration measurements are traceable to the U.S. National Bureau of Standards to the extent allowed by the Bureau's calibration facilities, or to the calibration facilities of other International Standards Organization members.

WARRANTY AND ASSISTANCE

This Hewlett-Packard product is warranted against defects in materials and workmanship. This warranty applies for one year from the date of delivery. Hewlett-Packard will repair or replace products which prove to be defective during the warranty period provided they are returned to Hewlett-Packard. No other warranty is expressed or implied. We are not liable for consequential damages.

Service contracts or customer assistance agreements are available for Hewlett-Packard products that require maintenance and repair on-site.

For any assistance, contact your nearest Hewlett-Packard Sales and Service Office. Addresses are provided at the back of this manual.

HEWLETT  PACKARD

OPERATING AND SERVICE MANUAL

8011 A PULSE GENERATOR

SERIAL NUMBERS

This manual applies directly to instruments with serial number 1411 G 01136 and higher. Any changes made in instruments having serial numbers higher than the above number will be found in a "Manual Changes" supplement (yellow pages) supplied with this manual. Be sure to examine this supplement for any changes which apply to your instrument and record these changes in the manual.

© HEWLETT-PACKARD GmbH 1975
D-703 BÖBLINGEN, HERRENBERGER STR. 110,
FEDERAL REPUBLIC OF GERMANY

CONTENTS

Section 1	General Information	Page
1-1	Description	1-1
1-6	Pulse Burst Option 001	1-1
Section 2	Installation	
2-1	General	2-1
2-2	Initial Inspection	2-1
2-5	Installation	2-1
2-6	Power Source Requirements	2-1
2-9	Power Cord	2-1
2-12	Temperature Requirements	2-2
2-14	Claims and Repackaging	2-2
2-15	Claims for Damage	2-2
2-17	Repackaging for Shipment and Storage	2-2
Section 3	Operating Instructions	
3-1	General	3-1
3-3	Modes of Operation	3-1
3-4	Internal	3-1
3-5	External	3-1
3-7	Burst Mode	3-2
Section 4	Principles of Operation	
4-1	Introduction	4-1
4-5	Rate Generator	4-1
4-15	Width Generator	4-2
4-19	Output Stages	4-3
4-20	Trigger Output Stages	4-3
4-22	Pulse Output Stages	4-3
4-25	Attenuator	4-3
4-27	Power Supply	4-3
4-30	8011A Option 001 - Pulse Burst	4-4
Section 5	Maintenance	
5-1	Introduction	5-1
5-3	Preventive Maintenance	5-1
5-6	Servicing	5-1
5-7	Removal of Assemblies	5-1
5-9	Performance Checks and Adjustment Procedures	5-1
5-10	Troubleshooting	5-1
Section 6	Diagrams and Replaceable Parts	
6-1	Introduction	6-1
6-3	Ordering Information	6-1
6-8	Circuit Diagram Waveforms	6-3
Section 7	Backdating	

ILLUSTRATIONS

Figure	Title	Page
2-1	8011A and Delivered Accessories	1-2
2-2	Power Cords	2-1
2-3	Switch Settings for the Various Nominal Powerline Voltages	2-1
3-1	Control and Connectors	3-0
3-2	8011A Internal Mode	3-1
3-3	8011A External Mode	3-1
3-4	External Triggering Timing Sequence	3-1
3-5	8011A Burst Mode	3-2
3-6	Examples of Repetitive and Single Burst Output	3-2
4-1	8011A Block Diagram	4-0
4-2	Repetition Rate Generator	4-1
4-3	Width Generator	4-2
4-4	Output Stages	4-3
4-5	Voltage Regulator	4-4
4-6	Pulse Burst Control	4-4
5-1	Assembly 1, Assembly 2: Troubleshooting Aid	5-20
Diagram		
1	Rate Generator	6-5
2	Width Generator and Selector Circuit	6-7
3	Output Stage	6-9
4	Power Supply	6-11
5	Opt. 001 Burst Board	6-13

TABLES

Table	Title	Page
1-1	Specifications	1-1
5-1	Test Equipment and Accessories Required	5-2
5-2	Performance Check - Repetition Rate	5-3
5-3	Performance Check - Manual Trigger	5-4
5-4	Performance Check - Pulse Width	5-5
5-5	Performance Check - Square Wave	5-6
5-6	Performance Check - Single Burst (8011A - Opt. 001)	5-7
5-7	Performance Check - Duty Cycle	5-8
5-8	Performance Check - Pulse Period Jitter	5-9
5-9	Performance Check - Pulse Width Jitter	5-10
5-10	Performance Check - External Trigger	5-11
5-11	Performance Check - High Frequency Triggering	5-12
5-12	Performance Check - Minimum Width	5-13
5-13	Performance Check - Preshoot, Overshoot and Ringing	5-14
5-14	Performance Check - Transition Time	5-15
5-15	Performance Check - Output Amplitude	5-16
5-16	Performance Check - Trigger Output	5-17
5-17	Performance Check - Repetitive Burst (8011A - Opt. 001)	5-18
5-18	Adjustment Procedure: Power Supplies	5-19
5-19	Adjustment Procedure: Base Line	5-20
5-20	Adjustment Procedure: Amplitude	5-21
5-21	Troubleshooting Procedures	5-23
5-22	Performance Test Record	5-38
5-23	Safety Check	5-40

Table	Title	Page
6-1	Reference Designators	6-1
6-2	Diagram Notes	6-2
6-3	List of Manufacturers Codes	6-3
6-4	Frame (Standard) Replaceable Parts List	6-4
6-5	Board A1 (Standard) Replaceable Parts List	6-6
6-6	Board A2 (Option 001) Replaceable Parts List	C-18
6-7	Frame (Option 001) Replaceable Parts List	6-19
6-8	Board A1 (Option 001) Replaceable Parts List	6-20

SAFETY SUMMARY

The following general safety precautions must be observed during all phases of operation, service, and repair of this instrument. Failure to comply with these precautions or with specific warnings elsewhere in this manual violates safety standards of design, manufacture, and intended use of the instrument. Hewlett-Packard Company assumes no liability for the customer's failure to comply with these requirements.

GENERAL – This is a Safety Class I instrument (provided with terminal for protective earthing) and has been manufactured and tested according to international safety standards.

OPERATION – BEFORE APPLYING POWER comply with the installation section. Additionally, the following shall be observed:

Do not remove instrument covers when operating.

Any interruption of the protective (grounding) conductor (inside or outside the instrument) or disconnecting the protective earth terminal is likely to make this instrument dangerous. Intentional interruption is prohibited.

Whenever it is likely that the protection has been impaired, the instrument must be made inoperative and be secured against any unintended operation.

Make sure that only fuses with the required rated current and of the specified type (normal blow, time delay, etc.) are used for replacement. The use of repaired fuses and the short-circuiting of fuseholders must be avoided.

Adjustments described in the manual are performed with power supplied to the instrument while protective covers are removed. Energy available at many points may, if contacted, result in personal injury.

Any adjustment, maintenance, and repair of the opened instrument under voltage should be avoided as much as possible, and when inevitable, should be carried out only by a skilled person who is aware of the hazard involved. Do not attempt internal service or adjustment unless another person, capable of rendering first aid and resuscitation is present. Do not replace components with power cable connected.

Do not operate the instrument in the presence of flammable gases or fumes. Operation of any electrical instrument in such an environment constitutes a definite safety hazard.

Do not install substitute parts or perform any unauthorized modification to the instrument.

Capacitors inside the instrument may still be charged even if the instrument has been disconnected from its source of supply.

SAFETY SYMBOLS



The apparatus will be marked with this symbol when it is necessary for the user to refer to the instruction manual in order to protect the apparatus against damage.



Indicates dangerous voltages.



Earth terminal (sometimes used in manual to indicate circuit common connected to grounded chassis).

WARNING The WARNING sign denotes a hazard. It calls attention to a procedure, practice or the like, which, if not correctly performed or adhered to, could result in injury or loss of life. Do not proceed beyond a WARNING sign until the indicated conditions are fully understood and met.

CAUTION The CAUTION sign denotes a hazard. It calls attention to an operating procedure, practice, or the like, which, if not correctly performed or adhered to, could result in damage to or destruction of part or all of the equipment. Do not proceed beyond a CAUTION sign until the indicated conditions are fully understood and met.



WARNING



Dangerous voltages, capable of causing death, are present in this instrument.
Use extreme caution when handling, testing, and adjusting.

1-1 DESCRIPTION

1-2 The Hewlett-Packard Model 8011A is a 20 MHz pulse source that can be externally and manually triggered. Ease of operation is ensured by logically arranged and clearly identified controls.

1-3 Pulse amplitudes up to 16V and selectable output format ensure compatibility with most logic families powered from either positive or negative supplies, and using either positive or negative logic conventions. Pulse width is continuously variable from 25ns to 100ms, or can be 50% of pulse period by selecting square wave mode.

1-4 Variable pulse width or square wave operation with up to 16V amplitude and the ability to pro-

duce positive, negative or symmetrical pulses in positive or negative logic make the instrument suitable for driving TTL, DTL, RTL, HTL and CMOS as well as discrete logic and linear circuits.

1-5 Serviceability is enhanced by using high quality components, and stable circuits reduce calibration adjustments to a minimum.

1-6 PULSE BURST OPTION 001

1-7 Thumbwheel switches on the front panel permit any number of pulses between 1 and 9999 to be preset. A "burst" starts on receipt of an electrical or manual trigger and ceases when the set number of pulses has been generated.

Table 1-1. Specifications

PULSE CHARACTERISTICS

(50 ohm source and load impedances)

Transition times: < 10ns fixed.

Overshoot, ringing and preshoot: < $\pm 5\%$ of pulse amplitude. May increase to 10% at counter-clockwise positions of amplitude vernier.

Pulse width: 25ns to 100ms in four ranges. Vernier provides continuous adjustment within each range.

Width jitter: < $0.1\% + 50\text{ps}$ for any width setting.

Maximum duty cycle: > 50% (100% using pulse complement).

Maximum output: 16V, with internal 50 ohms and external high impedance load or, with internal high impedance and external 50 Ω . 8V with 50 Ω source and load impedances.

Attenuator: three step attenuator provides the ranges 0.25V - 1V - 4V - 16V. Vernier provides continuous adjustment within each range.

Source impedance: 0.25V - 1V - 4V ranges, 50 ohms $\pm 10\%$ shunted by 30pF. 4V-16V range, 50 ohms $\pm 10\%$ or high impedance switch selectable.

Polarity: positive, negative or symmetrical switch selectable.

Format: normal or complement switch selectable.

REPETITION RATE AND TRIGGER

Repetition rate: 0.1 Hz to 20 MHz.

Period Jitter: < $0.1\% + 50\text{ps}$ for any period setting.

Square wave: 0.05 Hz to 10 MHz.

Trigger output: dc coupled 50 ohm (typ) source delivering $\geq +1\text{V}$ across 50 ohm load.

Trigger pulse width: 20ns \pm 10ns.

EXTERNALLY CONTROLLED OPERATION

External Input

Input impedance: 50 ohms $\pm 10\%$

Maximum input: $\pm 5\text{V}$

Trigger polarity: positive.

Table 1-1. Specifications (cont'd)

Sensitivity: 1V

Manual: front panel pushbutton for generating single pulse.

External Triggering

Repetition rate: 0 to 20 MHz. In square wave, output frequency is half input frequency.

Trigger source: manual or external signal. Min external signal width, 10ns.

Burst mode (optional): preselected number of pulses generated on receipt of trigger.

Burst trigger source: external signal or manual. Min external signal width, 25ns.

GENERAL

Operating temperature: 0°C to 55°C

Power: 100V, 120V, 220V or 240V, +5% -10%. 48 Hz to 440 Hz, 70 VA max.

Weight: net 4 kg (9 lbs), shipping 6.5 kg (14.6 lbs).

Dimensions: 200mm wide, 142mm high, 300mm deep (7.9 in. x 5.6 in. x 11.8 in.).

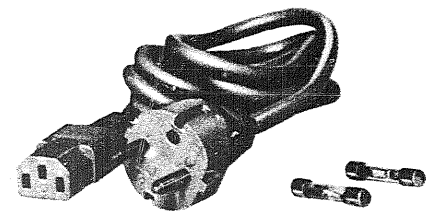
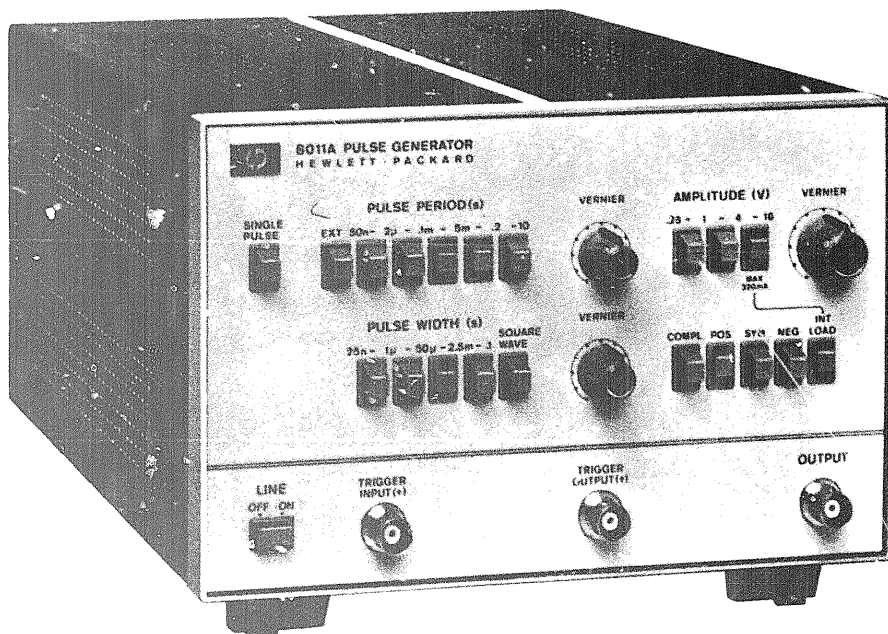

Figure 2-1. 8011A and Delivered Accessories

2-1 GENERAL**2-2 Initial Inspection**

2-3 Inspect the instrument and accessories for physical damage and if damage is evident refer to paragraph 2-14 for the recommended claim procedure and repacking information.

2-4 The 8011A is supplied with the following items:

Description	HP Part Number
300mA fuse (for 220/240V operation)	2110-0044
600mA fuse (for 110/120V operation)	2110-0016
Power Cord (one of those shown in figure 2-2).	

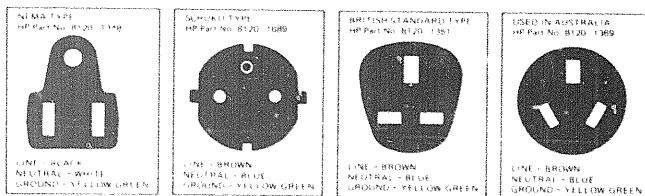

Figure 2-2. Power Cords

2-5 INSTALLATION**CAUTION**

Before applying power to the instrument, check that the 8011A is set in accordance with local supply conditions. To gain access to the voltage selector switches and fuse holder remove cover adjacent to the LINE switch.

2-6 Power Source Requirements

2-7 The model 8011A will operate from nominal ac line supplies of 100V, 120V, 220V, or 240V (-10%, +5%) at 48 Hz to 440 Hz. Two internally mounted switches allow one of the four voltages to be selected.

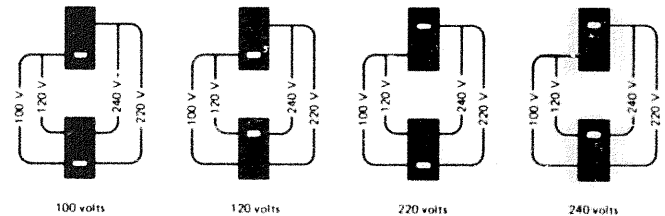

Figure 2-3. Switch Settings for the Various Nominal Powerline Voltages. The power dissipation is 70VA maximum.

2-8 To check the power requirements proceed as follows:

Disconnect the power cable.
Remove the fuse and check its value:
for 230V operation 300mA
for 115V operation 600mA

Check that the line selector switch position corresponds to the local supply voltage. If they do not correspond use a screwdriver to change the switch positions.

Insert the correct fuse into the fuse holder.

Connect the power cable to the rear connector.

2-9 Power Cord

2-10 The 3-wire power cable supplied with the 8011A when connected to the appropriate power outlet, grounds the instrument cabinet and panels. To preserve this safety feature when operating the instrument from an outlet without a ground connection use an appropriate adapter and connect the ground lead (green/yellow) to an external ground.

2-11 If the plug on the cable does not fit your power outlet then cut the cable at the plug end and connect a suitable plug. The plug should meet local safety requirements and include the following features:

- Minimum current rating of 1A.
- Ground connection
- Cable clamp

The colour coding used in the cable will depend on the cable supplied (see Figure 2-2 above).

2-12 Temperature Requirements

2-13 The model 8011A operates within specifications when the ambient temperature is between 0°C (32°F) and 55°C (131°F). The pulse generator may be stored between -40°C (-40°F) and 75°C (167°F).

2-14 CLAIMS AND REPACKAGING

2-15 Claims for Damage

2-16 If physical damage is evident or if the instrument does not meet specifications when received,

notify the carrier and the nearest Hewlett-Packard Sales/Service Office. The Sales/Service Office will arrange for repair or replacement of the unit without waiting for settlement of the claim against the carrier.

2-17 Repackaging for Shipment and Storage

2-18 If the instrument is to be shipped to a Hewlett-Packard Sales/Service Office, attach a tag showing owner, address, model and serial number and the repair required. The original shipping carton and packing material may be re-usable but the Hewlett-Packard Sales/Service Office will also provide information and recommendations on materials to be used if the original packing is not available or re-usable.

2-19 RACK MOUNTING

2-20 To rack mount model 8011A, order model 15179A Adapter for rackmounting 2 units

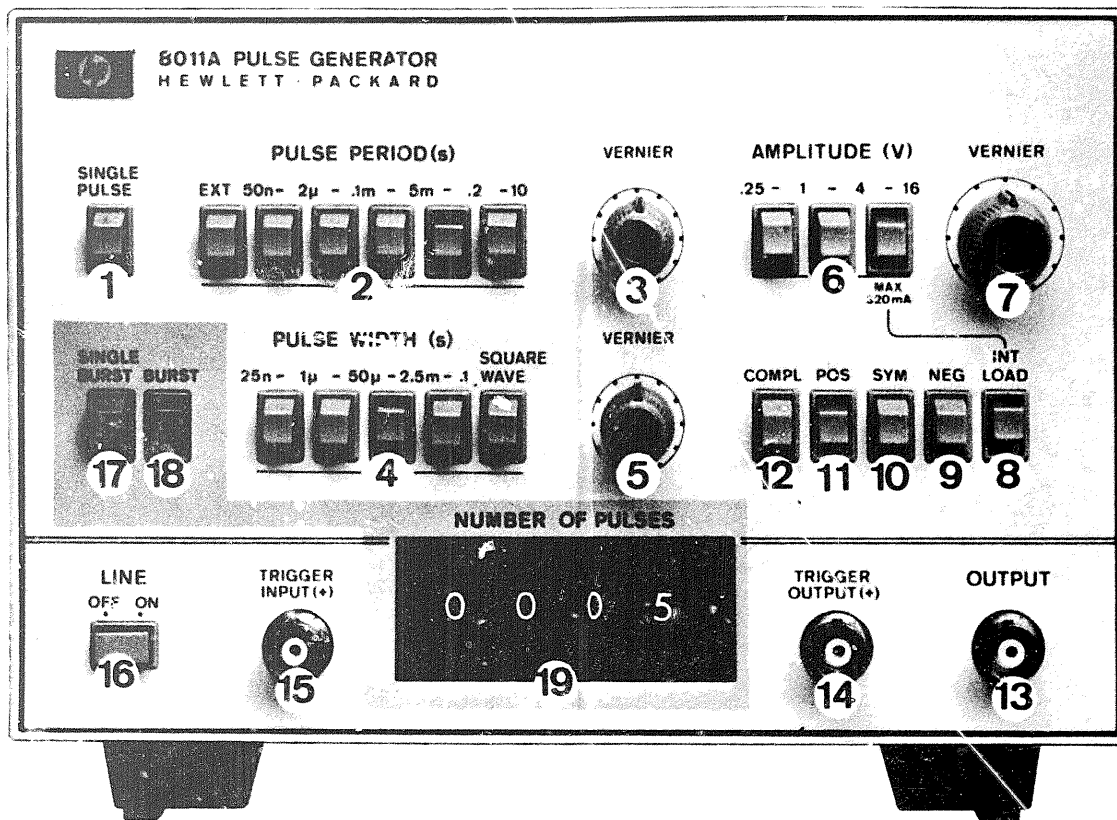

- 1 SINGLE PULSE: push-button for manually generating a single pulse in the EXTERNAL and Burst modes.
- 2 PULSE PERIOD: mutually exclusive push-buttons for selecting the range of pulse rate in the internal mode of operation. When EXT is selected rate controls are disabled.
- 3 Rate VERNIER: for continuous adjustment of the repetition rate between the limits of the range selected. Clockwise rotation increases the pulse period (i.e. reduces the rate).
- 4 PULSE WIDTH: mutually exclusive push-buttons for selecting pulse width range.
- 5 Pulse Width VERNIER: for continuous adjustment of pulse width between the limits of the range selected (is inoperative in SQUARE WAVE).
- 6 AMPLITUDE: mutually-exclusive push-buttons for selecting amplitude range. Note that, in the 4-16 Volt range the maximum current available is 320mA (from a current source) and in the other ranges the source impedance is 50Ω.
- 7 Amplitude VERNIER: for continuous adjustment of the amplitude between the limits of the range selected.
- 8 INT LOAD: push-button switch for connecting (pressed) and disconnecting (released) the 50Ω internal load in the 4-16 Volt range. In the other ranges the 50Ω load is always connected.
- 9 NEG: push-button for selecting negative polarity output.
- 10 SYM: push-button for selecting an output which is symmetrical about zero volt.
- 11 POS: push-button for selecting positive polarity output.
- 12 COMPL: push-button for selecting the pulse complement of the set pulse.

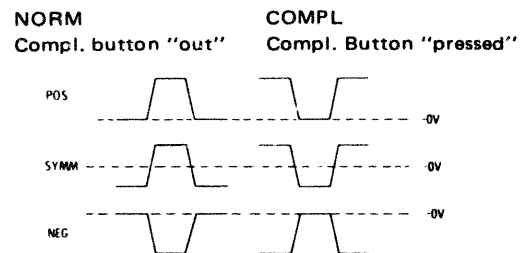

- 13 OUTPUT: BNC connector, 50Ω source (or, on 4-16 Volt range, current source if INT LOAD is released).
- 14 TRIGGER OUTPUT (+): BNC connector, positive trigger pulses from internal rate generator.
- 15 TRIGGER INPUT (+): BNC connector, to which external input signal is applied in EXTERNAL mode and Burst mode. Maximum input signal +5V.
- 16 LINE ON-OFF: press-for-on-press-for-off switch.

OPTION 001

- 17 SINGLE BURST: push-button for initiating a pulse burst.
- 18 BURST: push-button switch for selecting pulse burst mode.
- 19 NUMBER OF PULSES: thumbwheel switches on which the required number of pulses in a burst is set.

Figure 3-1. Controls and Connectors

OPERATING INSTRUCTIONS

3-1 GENERAL

3-2 The following instructions apply to model 8011A-Option 001. For the standard model, the instructions 3-7 and 3-8 for burst operation should be ignored.

3-3 MODES OF OPERATION

3-4 Internal

In this mode the 8011A requires no external signal to produce an output. Figure 3-2 shows the control which are effective in this mode.

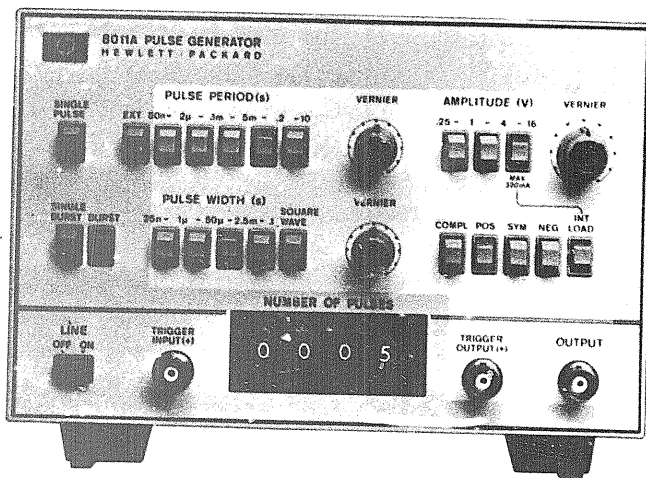

Figure 3-2. 8011A Internal Mode

3-5 External

3-6 In EXT 2 mode the repetition rate generator is externally triggered by a signal applied to the TRIGGER INPUT 15 or manually by means of the SINGLE PULSE push button 1. Figure 3-3 shows the controls which are effective in this mode.

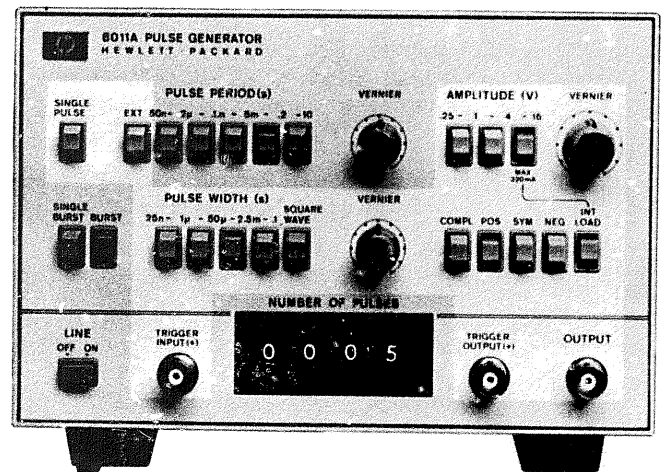

Figure 3-3. 8011A External Mode

Figure 3-4 illustrates the timing sequence between the trigger input and trigger and pulse outputs. Note that in SQUARE WAVE the trigger output frequency is half that of the external input.

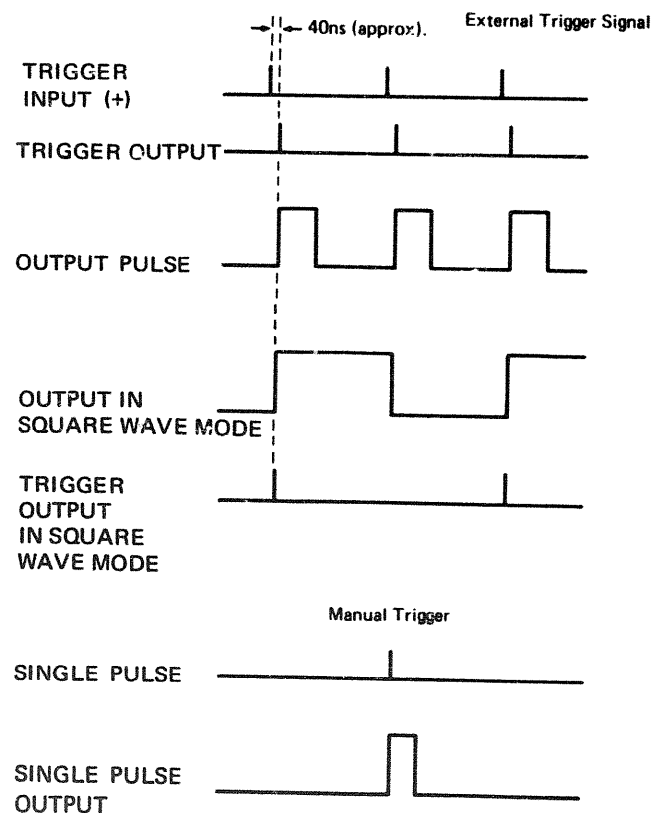

Figure 3-4. External Triggering Timing Sequence

3-7 Burst Mode

3-8 To operate the generator in BURST Mode press the BURST push-button 18, set the required NUMBER OF PULSES on the thumbwheel switches 19 and set the pulse parameters (rate, width, etc) on the front panel. A burst is started by pressing the SINGLE BURST button 17 or by applying a signal to the TRIGGER INPUT 15. At the end of a burst, single pulses can be added by pressing the SINGLE PULSE button. Figure 3-5 shows the controls which are effective in this mode and figure 3-6 illustrates examples of repetitive and single burst output.

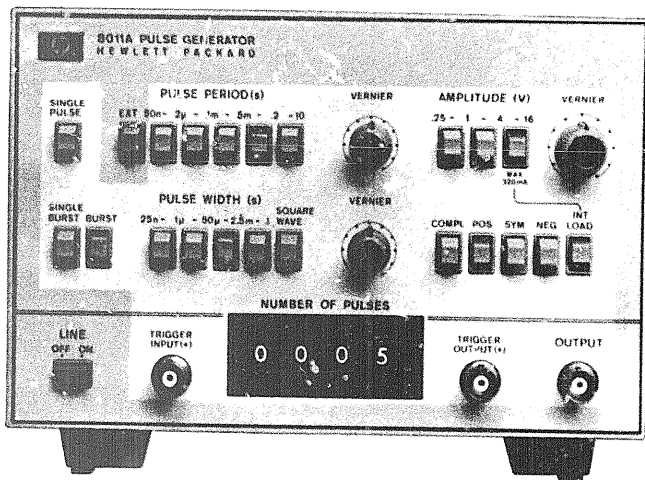
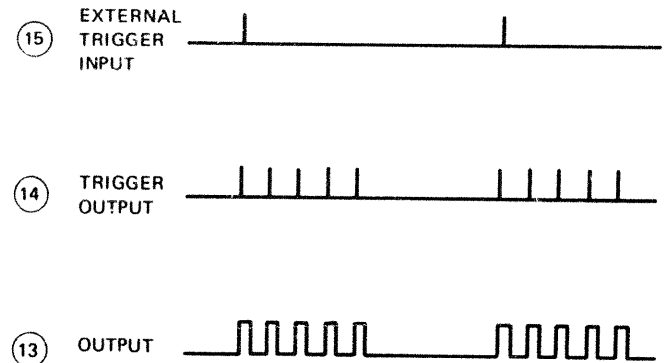

Figure 3-5. 8011A Burst Mode

REPETITIVE BURST



SINGLE BURST

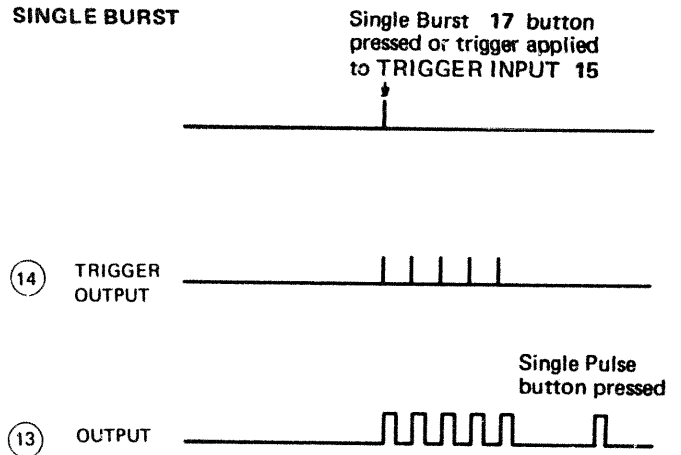

Figure 3-6. Examples of Repetitive and Single Burst Output.

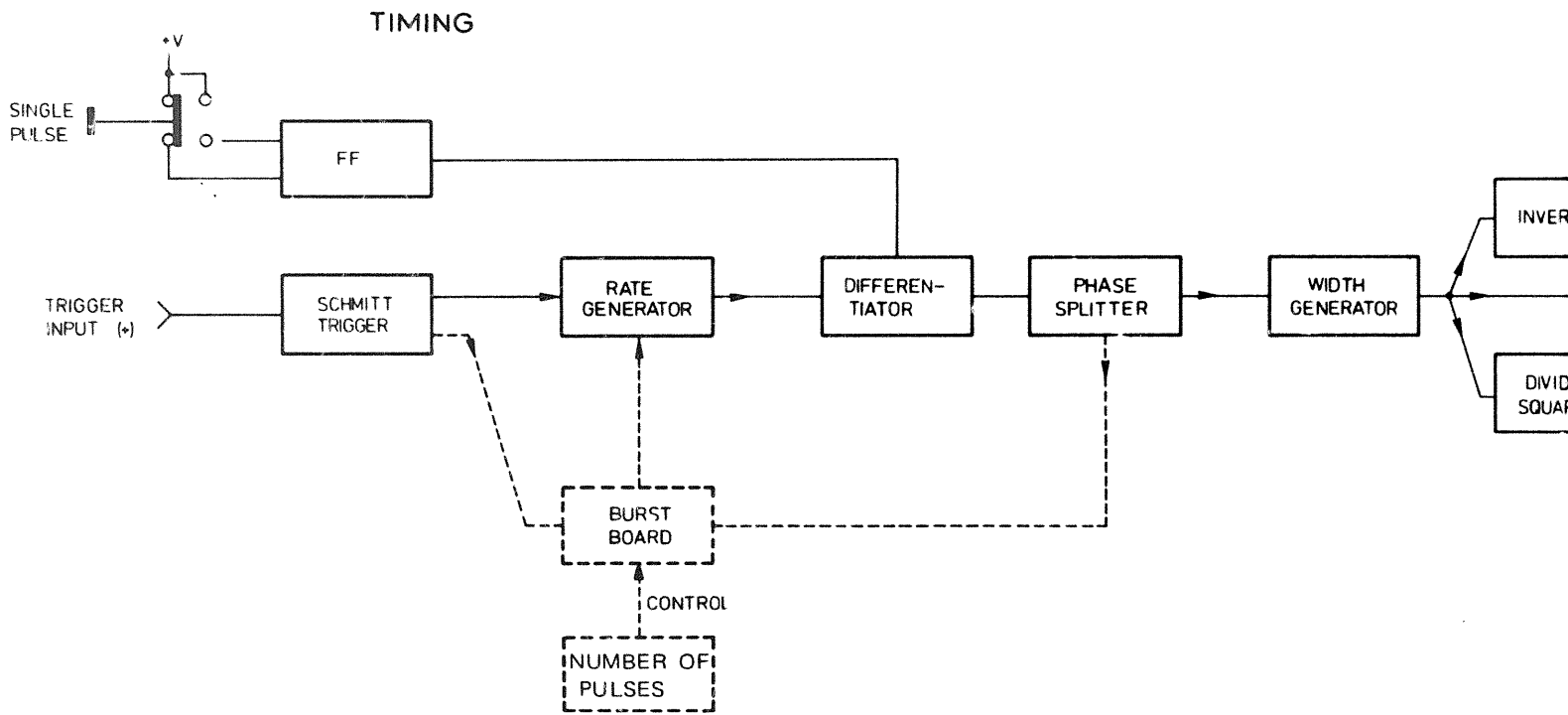
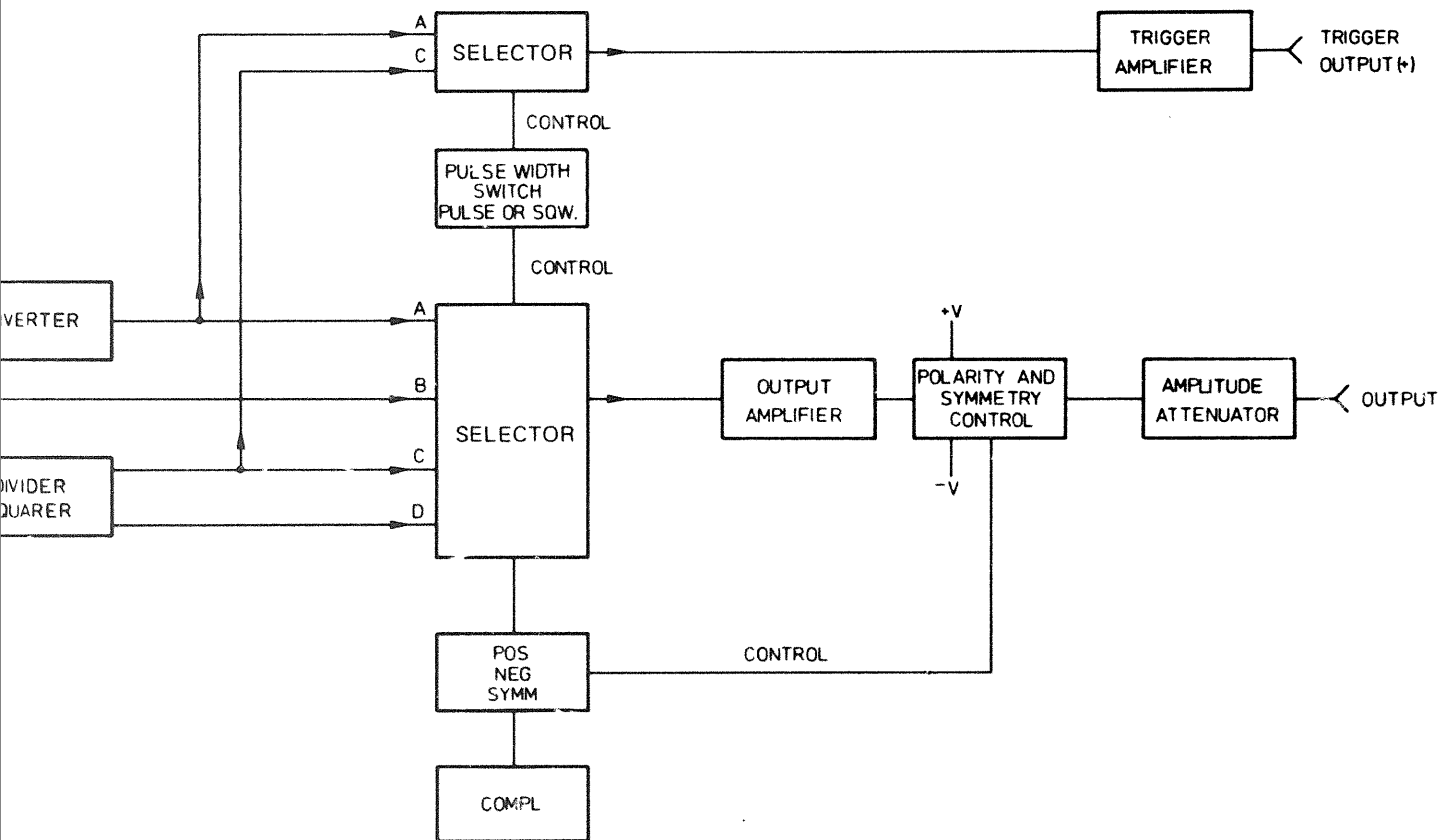

Figure 4-1. 8011A Block Diagram

PULSE SHAPING



4-1 INTRODUCTION (figure 4-1)

4-2 In normal mode operation, the rate generator is free-running at a rate determined by the PULSE PERIOD controls. In the external mode the disabled rate generator is turned on and off by the signal applied to the TRIGGER INPUT connector. The pulse generator can also be manually triggered by means of the SINGLE PULSE button which gives stimulus to the pulse shaping circuits via a flip-flop. When the 8011A has the Burst Option (001) the rate generator can be turned on by an external signal and turned off after a predetermined number of pulses have been generated.

4-3 In all modes of operation the pulse shaping circuits define the width (or square wave) and whether the normal or complement of the signal is to be used to drive the output stages. The conditioned signals (A,B,C

and D) are selected by a series of OR gates. Symmetry and polarity control and baseline correction take place in the output stage.

4-4 The trigger amplifier is driven by either signal A, which is the rate signal via an inverter in pulse width mode, or by signal C, which is the Q output from the divider squarer flip-flop in square wave mode.

4-5 RATE GENERATOR (Figure 4-2 and Diagram 1)

4-6 In the internal mode of operation the rate generator is free running and produces spikes at a rate determined by a multivibrator under the control of the PULSE PERIOD switch and RATE vernier. Under no-signal conditions in EXT mode, the rate generator is disabled. The pulse rate is then dependent on the frequency of the input signal which turns the multivibrator on and off.

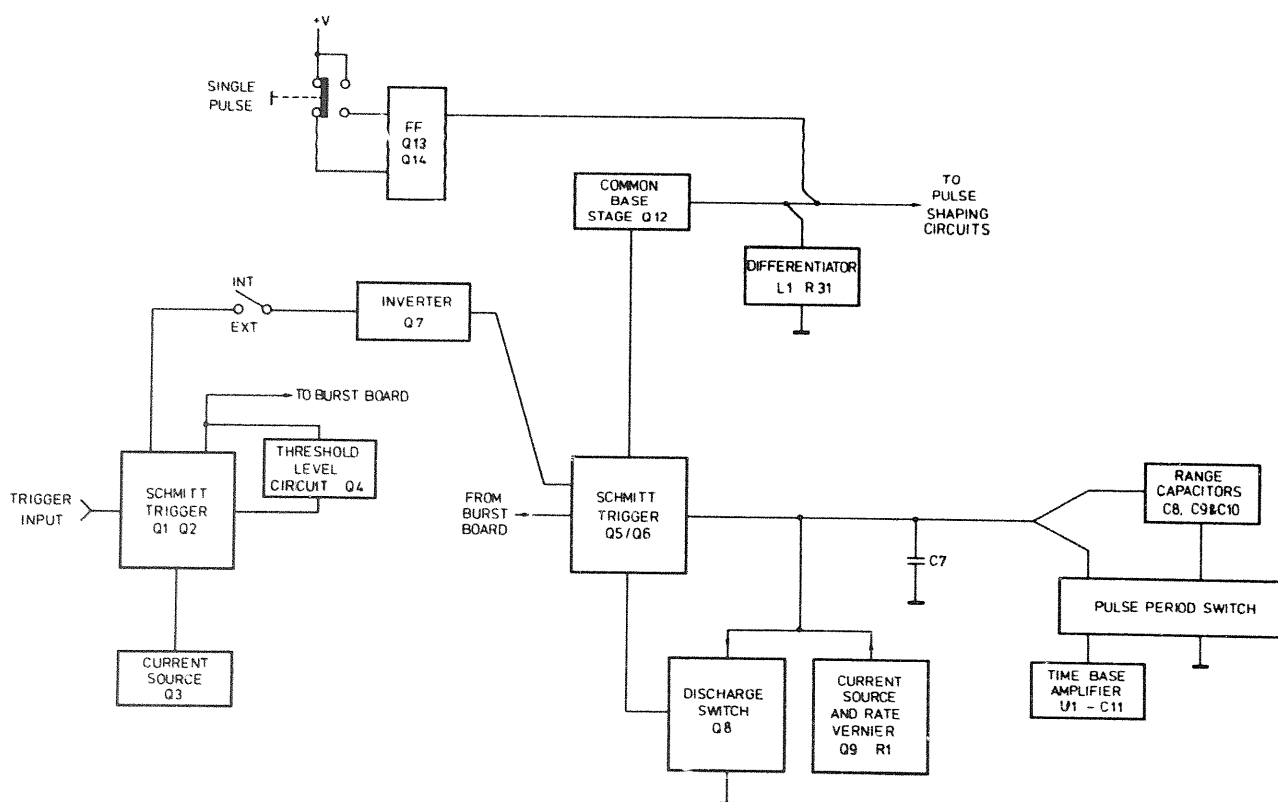

Figure 4-2. Repetition Rate Generator

4-7 The rate generator is a Schmitt trigger (Q5 and Q6) which switches when the voltage output of a ramp generator (Q9, vernier R1 and one or more of the range capacitors C7 to C10) reaches its threshold level. When switched it activates a switch (Q8) which rapidly discharges the ramp capacitor(s), causing the voltage to fall and reset the Schmitt trigger. This turns the switch off and the cycle repeats. Each time Q5 is turned off, a positive spike appears at differentiator (L1R31).

4-8 In the slowest rep rate range the available ramp current is reduced in order to prolong the charge cycle. That is, the capacitance of C10 is effectively increased during the charge cycle by "bleeding-off" the ramp current and thus increasing the time taken to charge the capacitor. For this purpose, a time base amplifier (U1) is connected in parallel with C10. This results in a division and reduction of the ramp current by an amount proportional to that drawn by the amplifier.

4-9 When the 0.2s - 10s range switch is closed, the voltage across the ramp capacitors C7 and C10 is amplified by a linear amplifier (U1 - A). The resulting signal, which is differentiated by C11, activates an operational amplifier (U1 - B) in order to equalize the IR drop across R29 with R30.

4-10 During the discharge cycle, the operational amplifier is disabled by the forward biased diode CR26 and the ramp capacitors are rapidly discharged.

4-11 The external input circuit comprises a Schmitt trigger (Q1 and Q2) a current source (Q3) and an inverter (Q7). Q4 maintains a constant voltage at the base of Q2 in spite of the changes in the supply caused by format selection. Refer to paragraph 4-27 for information concerning the power supplies.

4-12 The leading edge of a positive signal applied to the TRIGGER INPUT turns Q1 on, Q7 on and Q5 off. Each time Q5 is turned off, a positive spike appears at the differentiator (L1/R31).

4-13 When the EXT mode is selected, the Schmitt trigger (Q5/Q6) is disabled. Each time the SINGLE PULSE push button is depressed, a flip-flop (Q13/Q14) rapidly turns on and then off. Each time the flip-flop is turned on, a positive spike appears at the differentiator (L1/R31).

4-14 In all modes of operation, the phase splitter (Q15/Q16) is turned on and off by the positive spikes applied to the base of Q15. When on, it produces a positive pulse to drive the width circuit and a negative pulse which is applied to the burst counter (when fitted).

4-15 WIDTH GENERATOR (Figure 4-3 and Diagram 2)

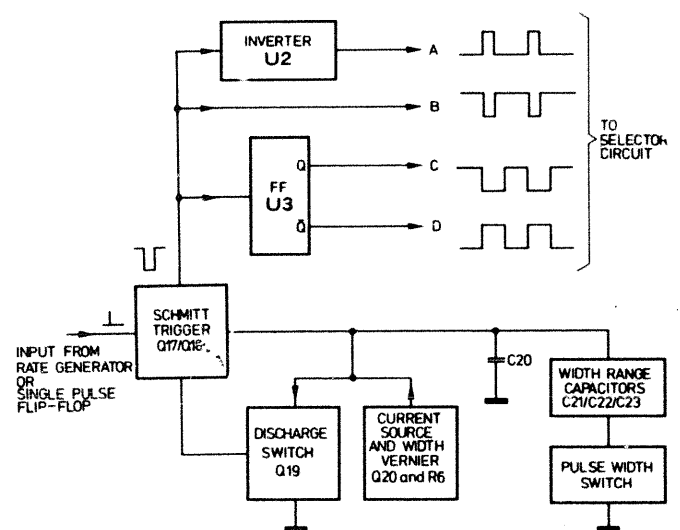

Figure 4-3. Width Generator

4-16 In the normal mode, the pulse leading edge occurs when Q17 turns on and Q18 off. The pulse width is determined by the time taken for the selected range capacitor (C20 and C21 or C22 or C23), charged from the variable current source (Q20/vernier R2), to reach the threshold level of the Schmitt trigger. The pulse trailing edge is created when the Schmitt trigger switches and turns on the discharge switch (Q19).

4-17 In selecting SQUARE WAVE, the width vernier (R2) is shorted and the narrowest pulse width range is automatically selected. This is in order to deliver a pulse of constant width to a divider-squarer flip-flop which generates the square wave.

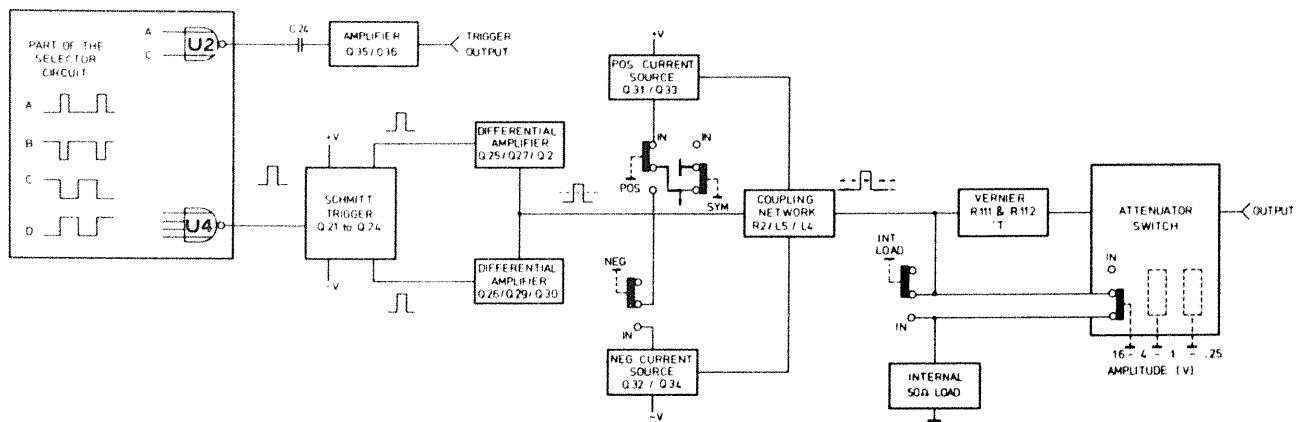

Figure 4-4. Output Stages

4-18 The Schmitt trigger output is applied directly (signal B) and via an inverter (U2 – signal A) and via the divider squarer (signals C and D) to an array of gates which select the required output as follows:

	Output Format	Mode	
		Pulse	Square Wave
Normal	Positive	B	D
	Symmetrical	B	D
	Negative	A	C
Complement	Positive	A	C
	Symmetrical	A	C
	Negative	B	D

4-19 **OUTPUT STAGES**
(Figure 4-4 and Diagrams 2 and 3)

4-20 **Trigger Output Stage (Q35, Q36)**

4-21 This is an ac-coupled cascode amplifier which produces a positive output pulse for each input pulse.

4-22 **Pulse Output Stage**

4-23 The function of the pulse output stage is to amplify the selected input signal, to supply the voltages for base line and polarity selection and attenuate the signal voltage to the required output level. The 50Ω internal load is always connected in the lower ranges but may be switched out in the 4-16 Volt range.

4-24 When POS output is selected, a positive current source (Q31, Q34) drives the output amplifier output above zero volts. For NEG outputs, a negative current source is enabled. Both current sources are disabled when SYMMetrical outputs are selected. The potentiometers R81 and R84 are used for positive (R81) and negative (R84) base line calibration.

4-25 **Attenuator**

4-26 The output attenuator comprises two resistive networks which provide stepped attenuation of the output. A bridged-T vernier provides continuous overlapping adjustment between the settings of the output attenuator. The internal 50Ω-load can be disconnected in the 4-16 Volt range when the INT LOAD button is released.

4-27 **POWER SUPPLY**
(Figure 4-5 and Diagram 4)

4-28 The positive and negative power supplies are identical monolithic voltage regulators (U5 and U6) with external PNP pass transistors (Q37 and Q38). The nominal output voltage with respect to the isolated PC board returns is ± 14V. The voltage levels with respect to zero volts, however, are dependent on the polarity and format switches:

- POS switch closed +22.3V/-5.7V
- NEG switch closed -22.3V/+5.7V
- SYMM switch closed ± 14V.

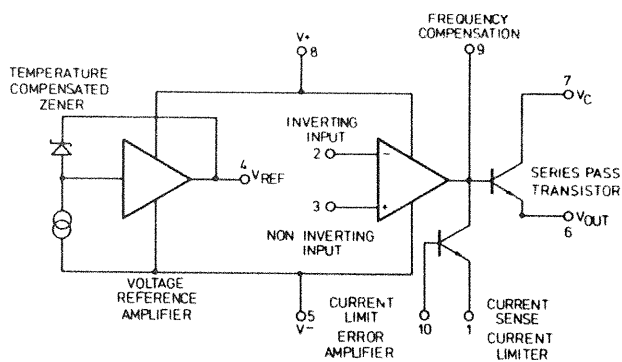

Figure 4-5. Voltage Regulator

4-29 A portion of the output voltage developed across the potential divider (R127, R129) is applied to an error amplifier which compares this with an internally developed reference voltage. If the difference between these voltages varies, the amplifier varies the base voltage of a series pass transistor which regulates the flow through Q37. Current limiting is accomplished by sensing the voltage drop across R123 by means of a current limiting device.

4-30 8011A Option 001 – Pulse Burst (Figure 4-6 and Diagram 5)

4-31 The Burst Control essentially consists of a counter which is loaded with numbers from front panel thumbwheel switches. When a burst is started, pulses from the rate generator decrement the counter until it is empty. This condition (all zeroes) is detected and generates a BURST COMPLETE signal which disables the rate generator.

4-32 The following description, in conjunction with figure 4-6, divides the burst operation into four successive stages:

1. Loading the Burst Counter
2. Start Burst
3. Zero Detection
4. Burst Complete

4-33 Loading the Burst Counter

4-34 When BURST mode is selected, the BURST ENABLE line goes high (0V) and 'clears' U19 (via Q7, C6, U13, U12), setting the Q output low. A low on this output then enables data to be loaded from the thumbwheel switches into the counter.

As data is being loaded, a comparator (U1, U2, U7 and U8) checks for equivalence between the counter inputs and outputs. When equivalence is detected, input pin 11 of U12d goes high, and the LOAD line (from output pin 13 of U12d) goes low thus preventing further loading of the counter.

4-35 Throughout this load process, the high on the \bar{Q} output of U19 disables the repetition rate generator (via AND gate CR11, CR12 and OR gate Q2, Q3), and therefore prevents the counter from counting.

4-36 Start Burst

4-37 When the START BURST signal is received, U19 is 'preset' (via NAND gate Q5, Q6) causing the Q and \bar{Q} outputs to change state. The low on the \bar{Q} output starts the repetition rate generator, and the counter begins to count down from the preset number. The high on the Q output of U19 ensures that the LOAD line remains disabled, thus preventing a re-load of the counter (e.g. by thumbwheel switch change) before the end of the burst.

4-38 Zero Detection

4-39 Throughout the count-down process, all outputs of the counter are monitored by two 'zero detect' configurations, one consisting of U9 and U11, and the other consisting of U9 and CR2→CR10. The significance of the two configurations is explained in the following Burst Complete description.

4-40 Burst Complete

4-41 When the counter reaches the 'all zero' condition, the fast 'zero detect' circuit (U9, CR2 → CR10) generates a BURST COMPLETE signal, which disables the repetition rate generator via OR gate Q2, Q3. This fast zero detection is achieved by using a 'hot carrier' diode for CR10, which monitors the final zero state, C1, of the counter. Fast detection then ensures that the repetition rate generator is switched off after the correct number of pulses have been output.

4-42 The other 'zero detect' circuit (U9, U11) clears U19, setting the Q output low again, and thus allowing the counter to be loaded once more from the thumbwheel switches.

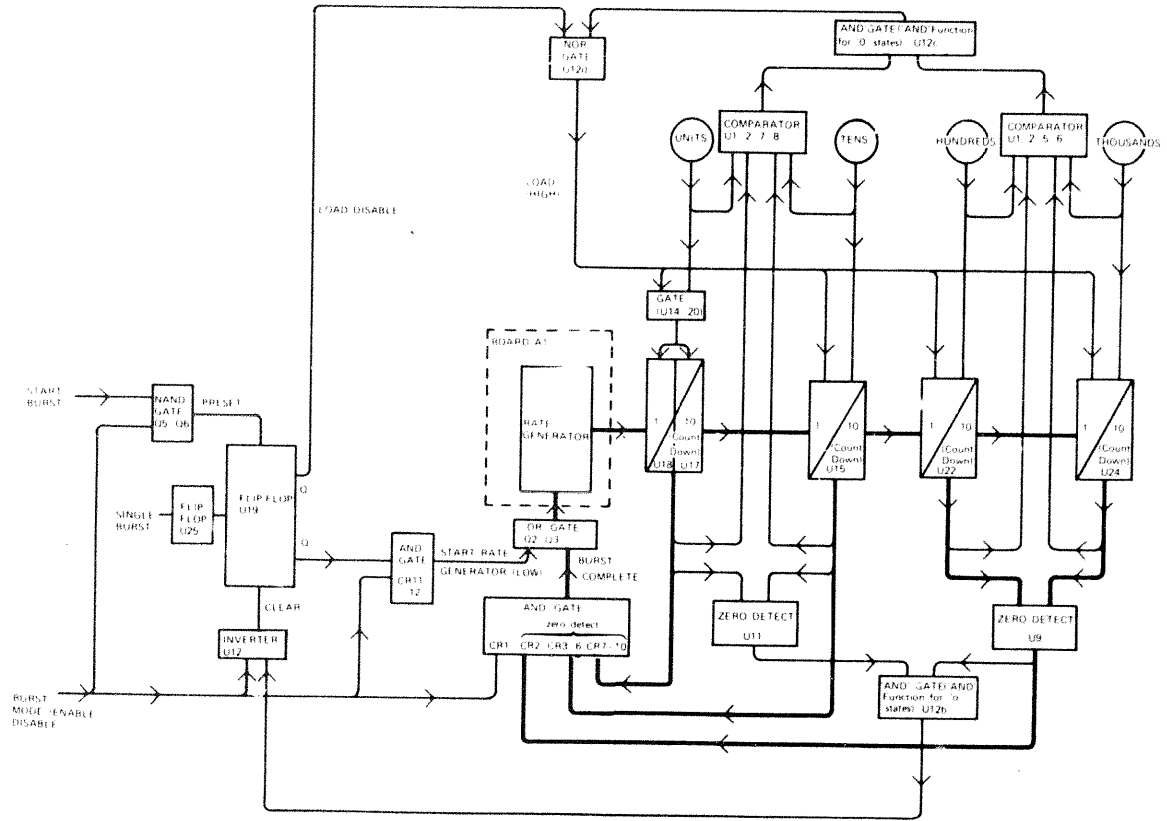

Figure 4-6. Pulse Burst Control

5-1 INTRODUCTION

5-2 The Model 8011A contains reliable components mounted on gold plated PC boards. These are subjected to a series of tests and calibration procedures which ensure accuracy and long life. In addition, maintenance and servicing is made easy by a non-complicated design and a simple "all on one board" construction.

5-3 Preventive Maintenance

5-4 The inherent reliability and accuracy of the pulse generator can be maintained by periodic cleaning and mechanical inspections. To gain access to the interior of the instrument remove the two panel covers. These are removed by releasing the four screws in the respective cover and sliding it away from the side of the instrument.

5-5 Remove dust from the interior and check that all fittings, connectors and boards are firmly in place. Check that the wiring and cables – especially those of power supply and line voltage – are in good condition. Ensure correct function of the controls by checking that the switch push rods and vernier knobs are able to move freely.

5-6 SERVICING

5-7 The following service information is only for servicing down to component level. When servicing the 8011A, if a fault cannot be localised within two hours, the complete instrument should be sent to the nearest repair centre.

NOTE: There is no board-exchange program for the 8011A.

5-8 Removal of Assemblies

5-9 The PC board should only be removed in extreme circumstances e.g. burnt board.

If necessary, however, the board can be removed as follows:

1. Remove AMPLITUDE vernier knob.
2. Remove the four screws that fix the rear panel to the frame.
3. Unsolder the TRIGGER IN cable, the TRIGGER OUT cable and the OUTPUT cable.
4. Unsolder WIDTH and RATE vernier cables.
5. Pull the 'rear panel/board' assembly out of the frame.
6. Unsolder transformer wires, power switch cables and power lamp cables.
7. Remove the two heat-sink screws from the rear panel.

5-10 Performance Checks and Adjustment Procedures

5-11 After completion of a repair or periodic inspection, verify that the instrument is working to specification by carrying out the performance checks (Table 5-2 to 5-17). Rigid observance to the sequence in which the checks appear is unnecessary. Table 5-18 and 5-19 give the procedures for checking and adjusting the power supplies and pulse base line.

5-12 Troubleshooting

5-13 When a fault symptom is evident, try to locate the fault to a functional block using figure 4-1. Then use table 5-21, the first page of which will indicate the direction in which troubleshooting is to proceed. The most convenient test point for the waveforms and voltages presented in the table can be located on figure 5-1.

Table 5-1. Test Equipment and Accessories Required

INSTRUMENT	BRIEF SPECIFICATION	RECOMMENDED MODEL
Oscilloscope	Dual Channel, 50 MHz bandwidth, sweep speeds 0.1 μ s/div. to 2 s/div. with sweep delay, 10mV/div. to 10 V/div. sensitivity.	HP 180C with plug-ins 1801A and 1821A
Sampling Oscilloscope	Dual Channel, 1 GHz bandwidth, 10mV/div. to 0.2 V/div. sensitivity, sweep speeds 1ns/div. to 10ms/div.	HP 180C with plug-ins 1810A
Counter	Frequency Range 0 to > 20 MHz	HP 5245L
VHF Test Oscillator	Frequency Range > 20 MHz	HP 3200B
Test Oscillator	Frequency Range 10 Hz to 10 MHz	HP 651B
Pulse Source	Frequency Range up to 20 MHz	HP 8011A
Digital Voltmeter	Sensitivity 0.1 V to 100 V	HP 34740A with plug-on HP 34702A
AC Voltmeter	Sensitivity 0.1 mV to 100mV	HP 3400A

ACCESSORIES	RECOMMENDED MODEL
50 Ω cable assy 23 cm long with BNC male connectors	HP 10502A
50 Ω cable assy 122 cm long with BNC male connectors (4 required)	HP 10503A
Test leads for DVM-dual banana plug to probe and clip	HP 110J3A
20 dB 20 W power attenuator	HP 8491A
Connector BNC male to type N female	HP 1250-0077
Connector type N male to BNC male	HP 1250-0780
Tee connector, BNC	HP 1250-0781
50 Ω feed-through termination (2 required)	HP 11048C
50 Ω adder/splitter	HP 15104A

Table 5-2. Performance Check – Repetition Rate

INITIAL CONTROL SETTINGS

PULSE PERIOD 2	50n – 2 μ
VERNIER 3	CCW
PULSE WIDTH 4	25n – 1 μ
VERNIER 5	CCW
AMPLITUDE 6	4 – 16
VERNIER 7	CW
POLARITY 11	POS
INT LOAD 8	ON

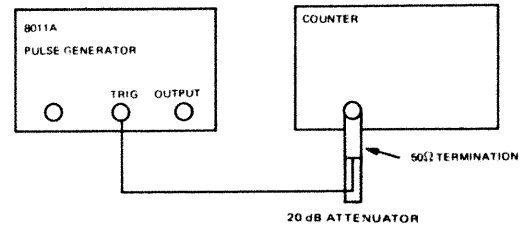

STEP	INSTRUCTION	RESULT	
1	Check the repetition rate for each setting of the controls listed below.		
	PULSE PERIOD 2	VERNIER 3	
	50n – 2 μ	CCW	>20MHz
		CW	<500kHz
	2 μ – 0.1m	CCW	>500kHz
		CW	<10kHz
	0.1m – 5m	CCW	>10kHz
		CW	<200Hz
2	For the following ranges set the counter for period measurement:		
	5m – 0.2	CCW	<5ms
		CW	>200ms
	0.2 – 10	CCW	<200ms
		CW	>10s.

Table 5-3. Performance Check – Manual Trigger

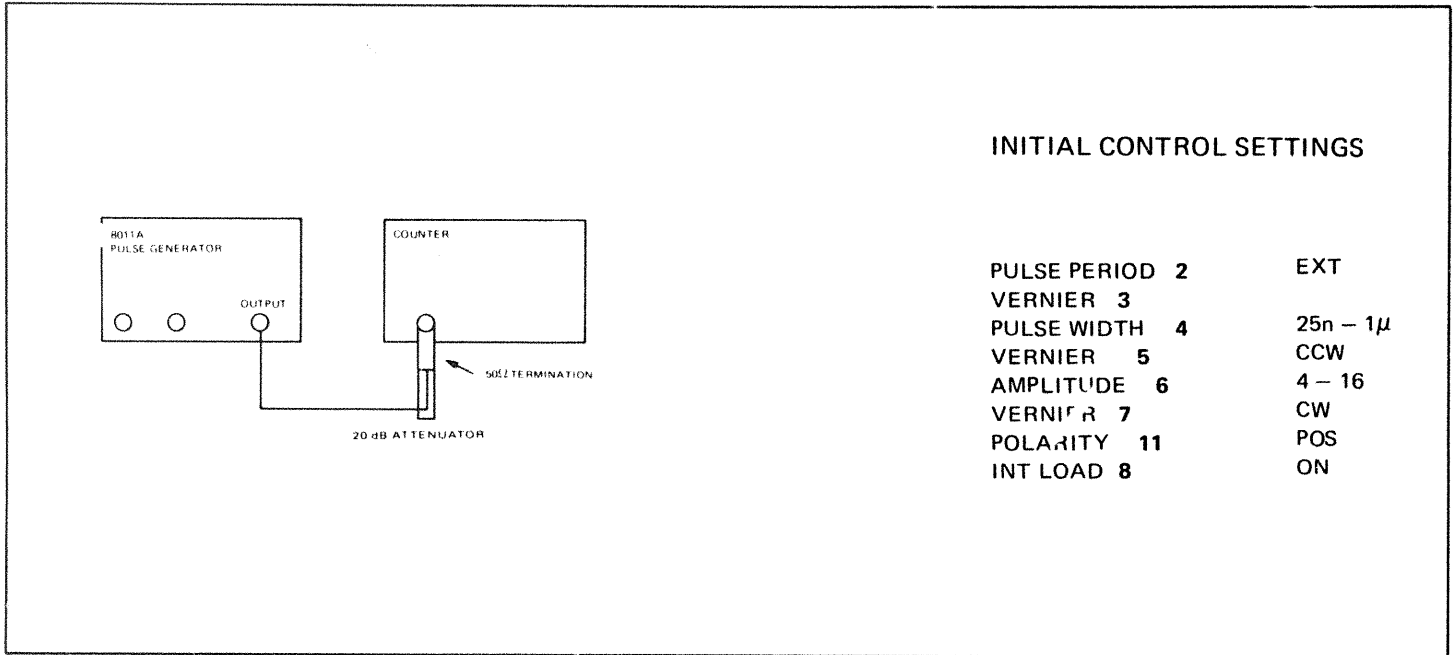

STEP	INSTRUCTION	RESULT
1	Set the counter for manual start.	
2	Press the SINGLE PULSE button once only:	1 pulse

Table 5-4. Performance Check – Square Wave

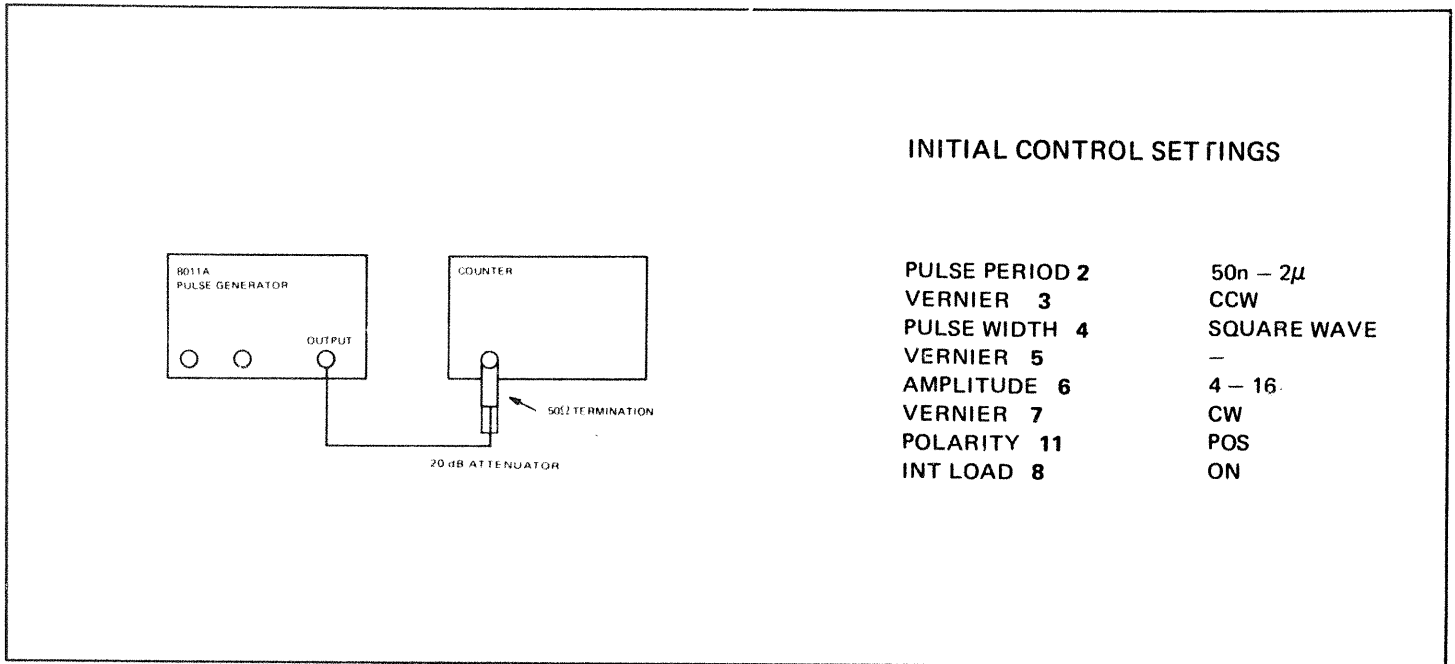

STEP	INSTRUCTION	RESULTS
1	Set the counter function to measure frequency.	
2	Check the square wave pulse for each control setting listed below:	
	PULSE PERIOD 2	
	50n – 2 μ	> 10 MHz
	2 μ – 0.1m	> 250 kHz
	0.1m – 5m	> 5 kHz
3	Set counter function to period average	
	5m – 0.2	< 10ms
	0.2 – 10	< 400ms

Table 5-5. Performance Check — Single Burst (8011A — Opt. 001)

INITIAL CONTROL SETTINGS

PULSE PERIOD	2	50n — 2 μ
VERNIER	3	CCW
PULSE WIDTH	4	25n — 1 μ
VERNIER	5	CCW
AMPLITUDE	6	4 — 16
VERNIER	7	CW
POLARITY	11	POS
INT. LOAD	8	ON
BURST MODES		ON
NUMBER OF PULSES	19	8011

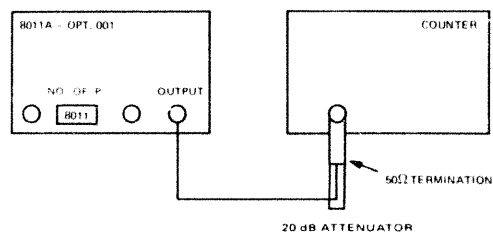

STEP INSTRUCTIONS

1 Press SINGLE BURST button:

RESULTS

8011 pulses

Table 5-6. Performance Check – Pulse Width

INITIAL CONTROL SETTINGS

PULSE PERIOD 2	50n – 2μ
VERNIER 3	CCW
PULSE WIDTH 4	25n – 1μ
VERNIER 5	CCW
AMPLITUDE 6	4 – 16
VERNIER 7	CW
POLARITY 11	POS
INT LOAD 8	ON

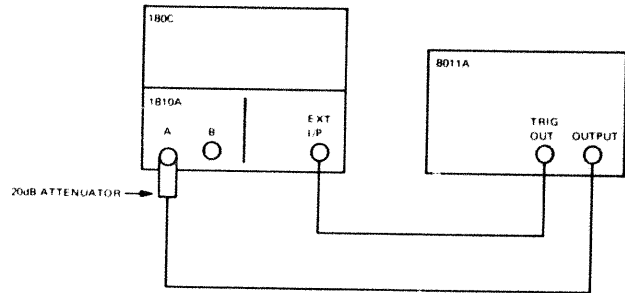

STEP	INSTRUCTION	RESULTS																														
1	Check the pulse width for each of the control settings listed below.																															
	<table border="0"> <tr> <td>PULSE PERIOD 2</td> <td>VERNIER 3</td> <td>PULSE WIDTH 4</td> <td>VERNIER 5</td> <td></td> </tr> <tr> <td>50n – 2μ</td> <td>CCW</td> <td>25n – 1μ</td> <td>CCW</td> <td>< 25ns</td> </tr> <tr> <td>2μ – .1m</td> <td>CCW</td> <td>1μ – 50μ</td> <td>CCW</td> <td>< 1μ</td> </tr> <tr> <td>.1m – 5m</td> <td>CCW</td> <td>50μ – 2.5m</td> <td>CCW</td> <td>< 50μ</td> </tr> <tr> <td>5m – .2</td> <td>CCW</td> <td>2.5m – .1</td> <td>CCW</td> <td>< 2.5m</td> </tr> <tr> <td></td> <td>CW</td> <td></td> <td>CW</td> <td>> .1s</td> </tr> </table>	PULSE PERIOD 2	VERNIER 3	PULSE WIDTH 4	VERNIER 5		50n – 2μ	CCW	25n – 1μ	CCW	< 25ns	2μ – .1m	CCW	1μ – 50μ	CCW	< 1μ	.1m – 5m	CCW	50μ – 2.5m	CCW	< 50μ	5m – .2	CCW	2.5m – .1	CCW	< 2.5m		CW		CW	> .1s	
PULSE PERIOD 2	VERNIER 3	PULSE WIDTH 4	VERNIER 5																													
50n – 2μ	CCW	25n – 1μ	CCW	< 25ns																												
2μ – .1m	CCW	1μ – 50μ	CCW	< 1μ																												
.1m – 5m	CCW	50μ – 2.5m	CCW	< 50μ																												
5m – .2	CCW	2.5m – .1	CCW	< 2.5m																												
	CW		CW	> .1s																												

CAUTION

Output power when 4-16 V range selected can destroy scope's internal 50 ohm load. Use a 20 dB power attenuator.

Table 5-7. Performance Check – Duty Cycle

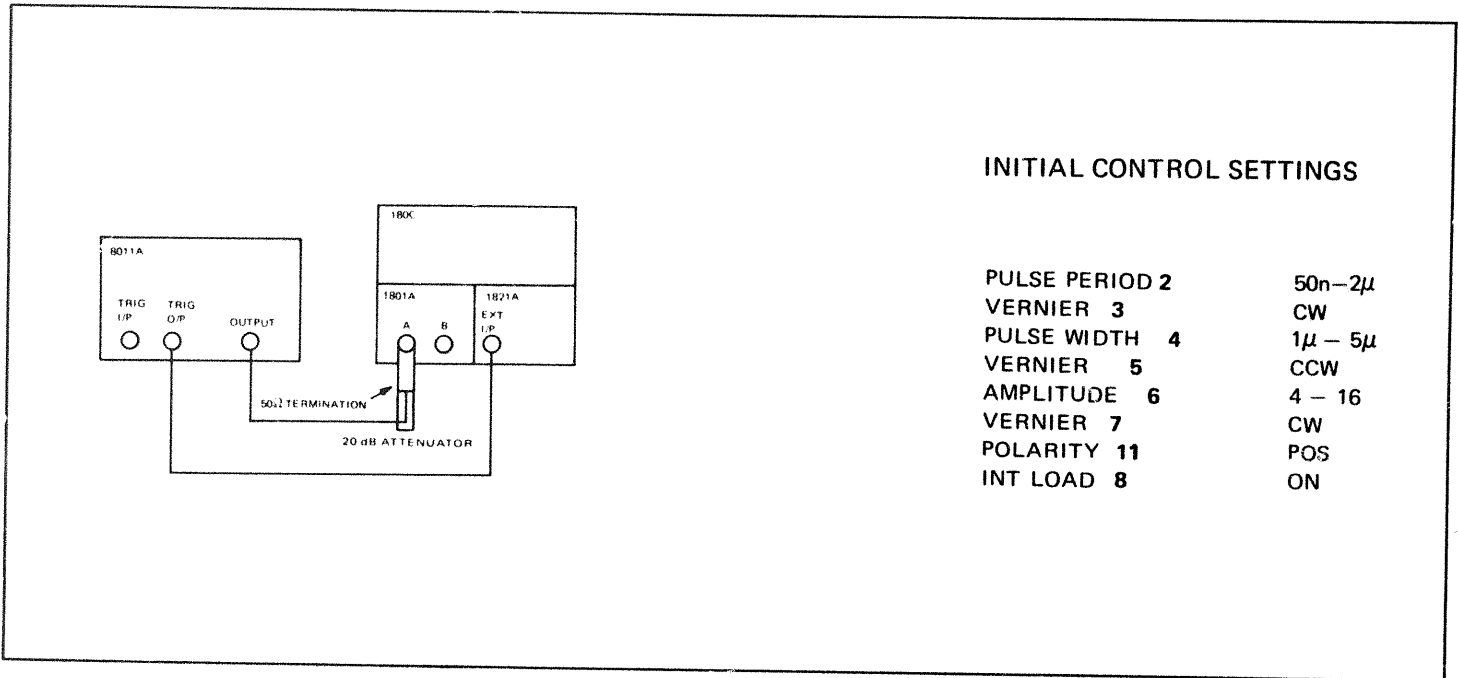

INITIAL CONTROL SETTINGS

PULSE PERIOD 2	50n-2μ
VERNIER 3	CW
PULSE WIDTH 4	1μ - 5μ
VERNIER 5	CCW
AMPLITUDE 6	4 - 16
VERNIER 7	CW
POLARITY 11	POS
INT LOAD 8	ON

- | STEP | INSTRUCTIONS | RESULTS |
|------|-----------------------------------------------------------------------------------------------------------------------------------------------------------------|---------|
| 1 | By means of the pulse width VERNIER 5. Set the pulse leading edge on the first line of the oscilloscope screen and the trailing edge on the centre line (5 cm). | |
| 2 | Turn the pulse period VERNIER 3 slowly CCW until the trailing edge moves and/or the pulse is divided. | |
| 3 | Measure the distance between the both pulse leading edges for each setting of the controls listed below: | |

PULSE PERIOD 2	PULSE WIDTH 4	VERNIER 5	Divisions
50n - 2μ	1μ - 50μ	as in	< 10 => 50%
2μ - 0.1m	50μ - 2.5m	step 1	< 10 => 50%
0.1m - 5m	2.5m - 0.1		< 10 => 50%

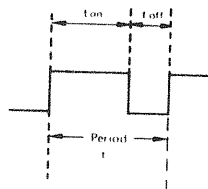

Duty cycle formula is $\frac{t_{on} \times 100}{t \text{ (period)}} \% = \% \text{ Duty Cycle}$

Table 5-8. Performance Check -- Pulse Period Jitter

INITIAL CONTROL SETTINGS

PULSE PERIOD	2	0.1m - 5m
VERNIER	3	see below
PULSE WIDTH	4	50μ - 2.5m
VERNIER	5	CCW
AMPLITUDE	6	4 - 16
VERNIER	7	CW
POLARITY	11	POS
INT LOAD	8	

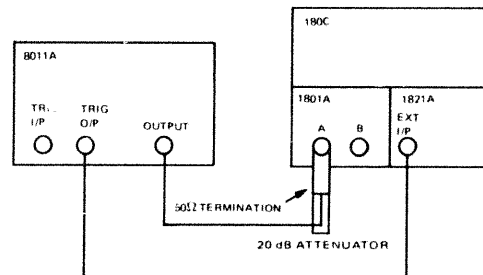

STEP INSTRUCTIONS

RESULTS

- 1 Main Sweep .1ms/div
Delayed Sweep 10μs/div
Sweep Display MAIN
Magnifier X 1
- 2 Adjust the pulse period VERNIER (3) to obtain a 1ms pulse period.
- 3 Adjust the oscilloscope delay (div.) until the intensified Spot coincides with the leading edge of the second pulse on the display.
- 4 Switch to Delayed sweep display on oscilloscope and Magnifier X 10
- 5 Measure pulse period jitter t_j .

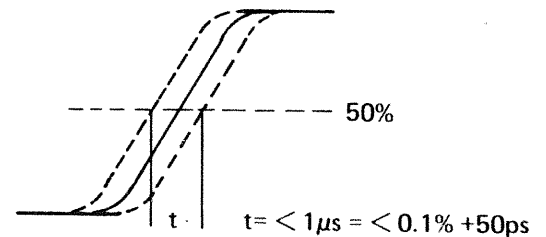

CAUTION

Output power when 4-16 V range selected can destroy an ordinary 50 ohm load. Use a 20 dB power attenuator or a 50 ohm power termination.

Table 5-9. Performance Check – Pulse Width Jitter

INITIAL CONTROL SETTINGS

PULSE PERIOD 2	0.1m – 5m
VERNIER 3	CW
PULSE WIDTH 4	50μ – 2.5m
VERNIER 5	CCW
AMPLITUDE 6	4 – 16
VERNIER 7	CW
POLARITY 11	POS
INT LOAD 8	ON

STEP	INSTRUCTIONS	RESULTS
1	Set the controls of the oscilloscope as follows Main Sweep .1ms/cm Delayed Sweep 10μs/cm Sweep Display MAIN Magnifier X 1	
2	Adjust the pulse width vernier to obtain a 1ms pulse width.	
3	Adjust the Delay (Div.) until the intensified spot coincides with the trailing edge of the first pulse	
4	Switch to Delayed sweep display on oscilloscope and Magnifier X 10	
5	Measure width jitter t	

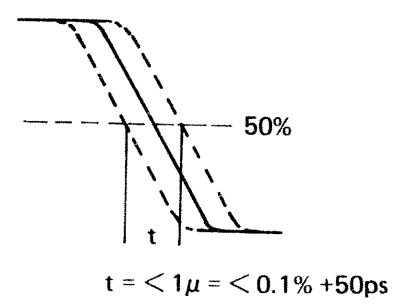

CAUTION

Output power when 4-16 V range selected can destroy an ordinary 50 ohm load. Use a 20 dB power attenuator or a 50 ohm power termination.

Table 5-10. Performance Check – External Trigger

INITIAL CONTROL SETTINGS

PULSE PERIOD 2	EXT
VERNIER 3	CW
PULSE WIDTH 4	50 μ – 2.5m
VERNIER 5	mid-position
AMPLITUDE 6	1 – 4
VERNIER 7	CW
POLARITY 11	POS
INT LOAD 8	ON

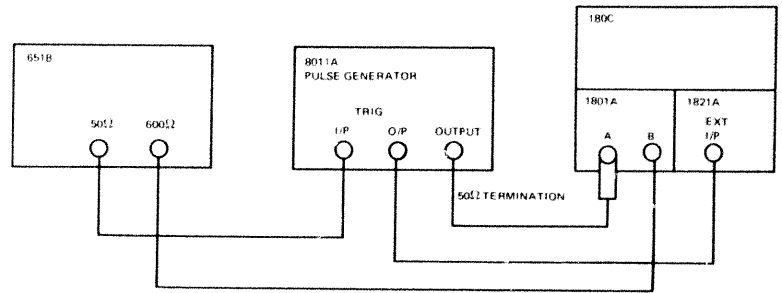

STEP INSTRUCTIONS

- 1 Adjust the oscillator output amplitude to 2.0Vpp and frequency to 1 kHz.
- 2 On the oscilloscope, center both channels vertically.
- 3 Observe pulse, ensure that pulse occurs during positive slope of the input sine wave.

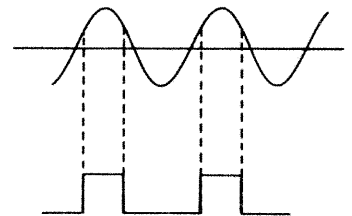
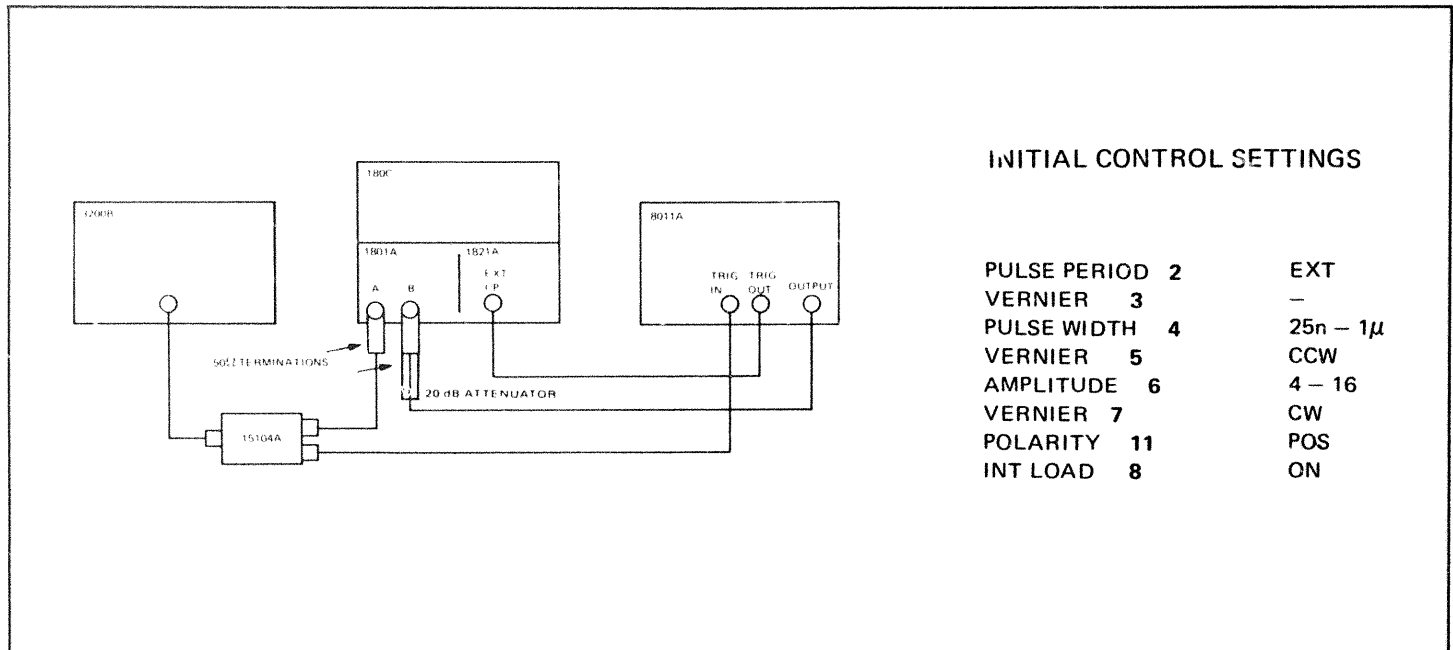

Table 5-11. Performance Check — High Frequency Triggering

**STEP INSTRUCTIONS**

- 1 Adjust the oscillator output amplitude for 2.0Vpp at 8011A TRIG IN.
Set Frequency to 20 MHz.

(NOTE: Perturbation delay of typically 50ns)

- 2 Check that the 8011A output pulse has the same pulse period as the external signal.
- 3 Set the 8011A to NEG and repeat steps 2 and 3.

Set the 8011A to SYMM and repeat steps 2 and 3.

CAUTION

Output power when 4–16 V range selected can destroy an ordinary 50 ohm load. Use a 20 dB power attenuator or a 50 ohm power termination.

Table 5-12. Performance Check - Minimum Width

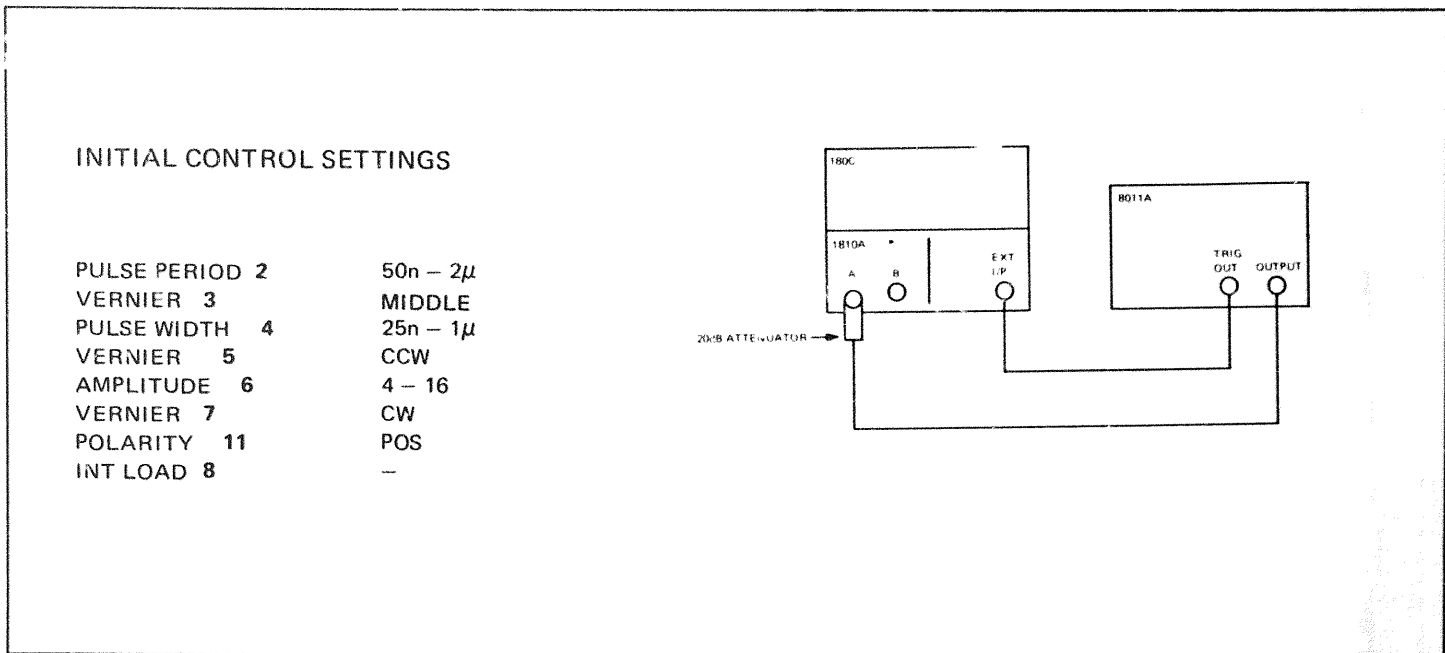

STEP	INSTRUCTIONS	RESULTS
1	Set the oscilloscope to obtain a full-screen pulse amplitude display.	
2	Measure pulse width at 50% of amplitude	< 25ns
3	Set 8011A controls to NEG and repeat steps 2 and 3	< 25ns

CAUTION

Output power when 4-16 V range selected can destroy scope's internal 50 ohm load. Use a 20 dB power attenuator.

Table 5-13. Performance Check – Preshoot, Overshoot and Ringing

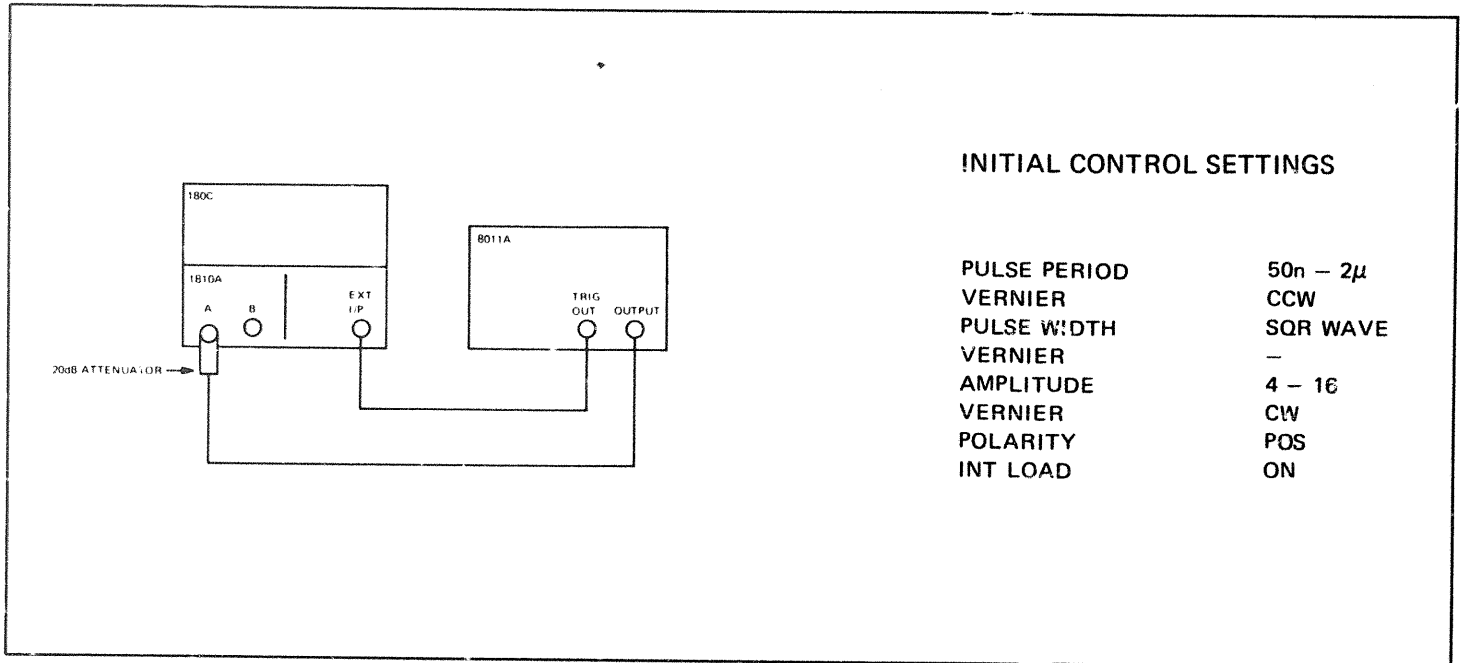

STEP INSTRUCTIONS

RESULTS

- 1 Set the oscilloscope to obtain a full-screen amplitude display.
- 2 With reference to the diagram below, measure preshoot, overshoot and ringing. All should be

≤ 5% of pulse* amplitude

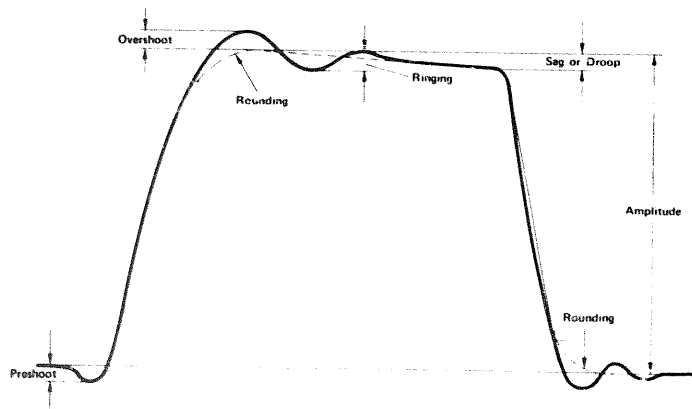

*Overshoot may increase to 10% with Amplitude vernier CCW.

- 3 Set INT LOAD to OFF. Verify preshoot, overshoot and ringing.

≤ 10 % of pulse amplitude

CAUTION

Output power when 4-16 V range selected can destroy scope's internal 50 ohm load. Use a 20 dB power attenuator.

Table 5-14. Performance Check – Transition Times

INITIAL CONTROL SETTINGS

PULSE PERIOD	2	50n – 2 μ
VERNIER	3	CCW
PULSE WIDTH	4	SQR WAVE
VERNIER	5	–
AMPLITUDE	6	4–16
VERNIER	7	ADJUST FOR 16V
POLARITY	11	POS
INT LOAD	8	OFF

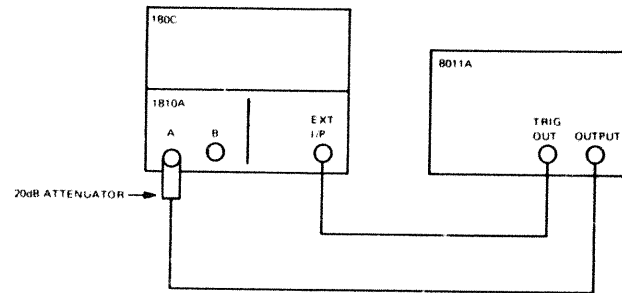

STEP	INSTRUCTIONS	RESULTS
1	Set the oscilloscope to obtain the following: (1) full screen amplitude display (2) expanded sweep (3) leading edge of pulse at centre of screen	
2	Measure leading edge between 10% and 90% of amplitude	< 10ns
3	Centralize trailing edge on screen	
4	Measure trailing edge between 10% and 90% of amplitude.	< 10ns

CAUTION

Output power when 4–16 V range selected can destroy scope's internal 50 ohm load. Use a 20 dB power attenuator.

Table 5-15. Performance Check — Output Amplitude

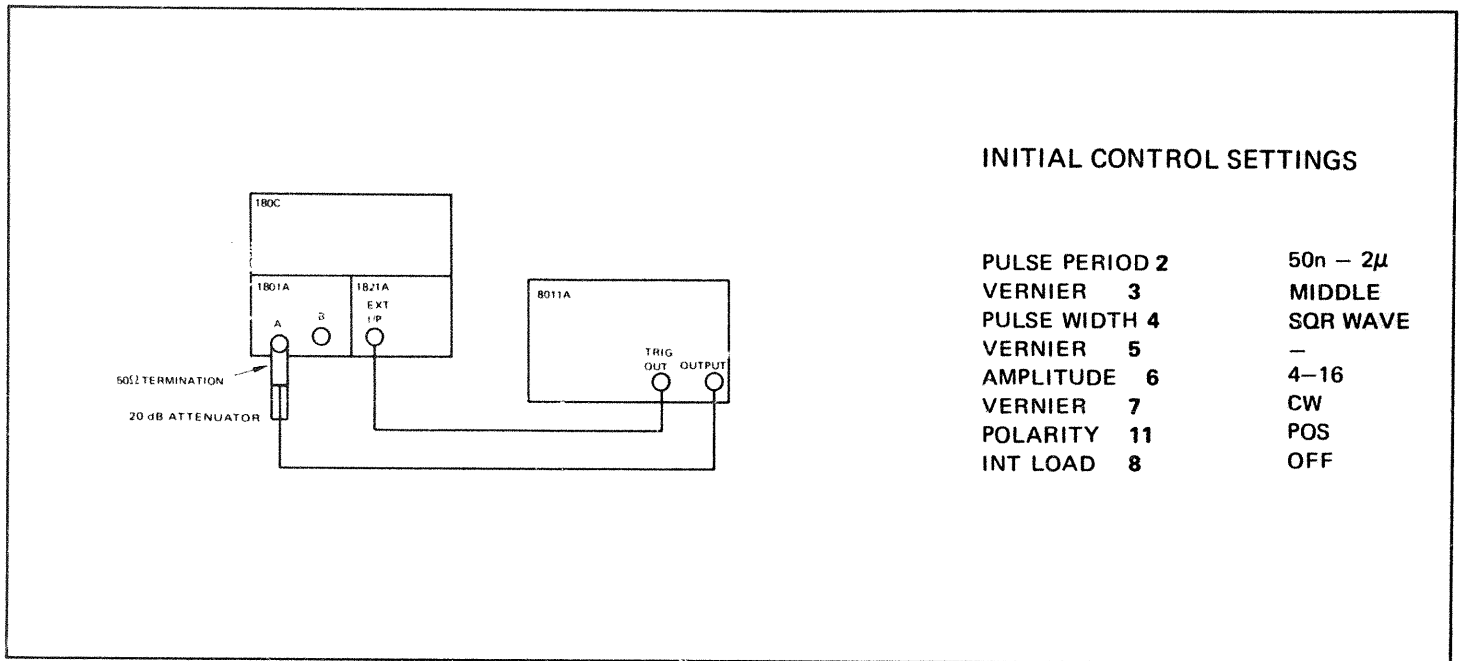

INITIAL CONTROL SETTINGS

PULSE PERIOD 2	50n - 2μ
VERNIER 3	MIDDLE
PULSE WIDTH 4	SQR WAVE
VERNIER 5	-
AMPLITUDE 6	4-16
VERNIER 7	CW
POLARITY 11	POS
INT LOAD 8	OFF

STEP	INSTRUCTIONS	RESULTS
1	Check the amplitude for each setting of the controls listed below	
	AMPLITUDE 6	VERNIER 7
	4 - 16	CW (with INT. LOAD OFF) > 16V
		CW (with INT. LOAD ON) > 8V
	1 - 4	CCW < 4V
		CW > 4V
	0.25 - 1	CCW < 1V
		CW > 1V
		CCW < 0.25V

CAUTION

Output power when 4-16 V range selected can destroy an ordinary 50 ohm load. Use a 20 dB power attenuator or a 50 ohm power termination.

Table 5-16. Performance Check – Trigger Output

INITIAL CONTROL SETTINGS

PULSE PERIOD	2	50n – 2 μ
VERNIER	3	CCW
PULSE WIDTH	4	25n – 1 μ
VERNIER	5	CCW
AMPLITUDE	6	0.25 – 1
VERNIER	7	CW
POLARITY	11	POS
INT LOAD	8	ON

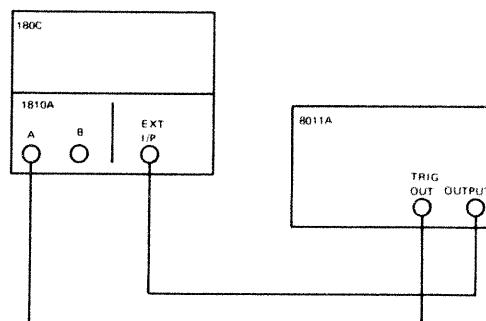

STEP INSTRUCTIONS

RESULTS

- 1 Check trigger output
(1) Amplitude:
(2) Width:

$\geq 1V$
 $> 10ns < 30 ns$

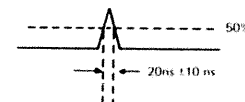

- 2 Turn 8011A pulse period vernier slowly clockwise and check that trigger output is as above
- 3 Set the 8011A to SQR WAVE and repeat step 2.

Table 5-17. Performance Check – Repetitive Burst (8011A – Opt. 001)

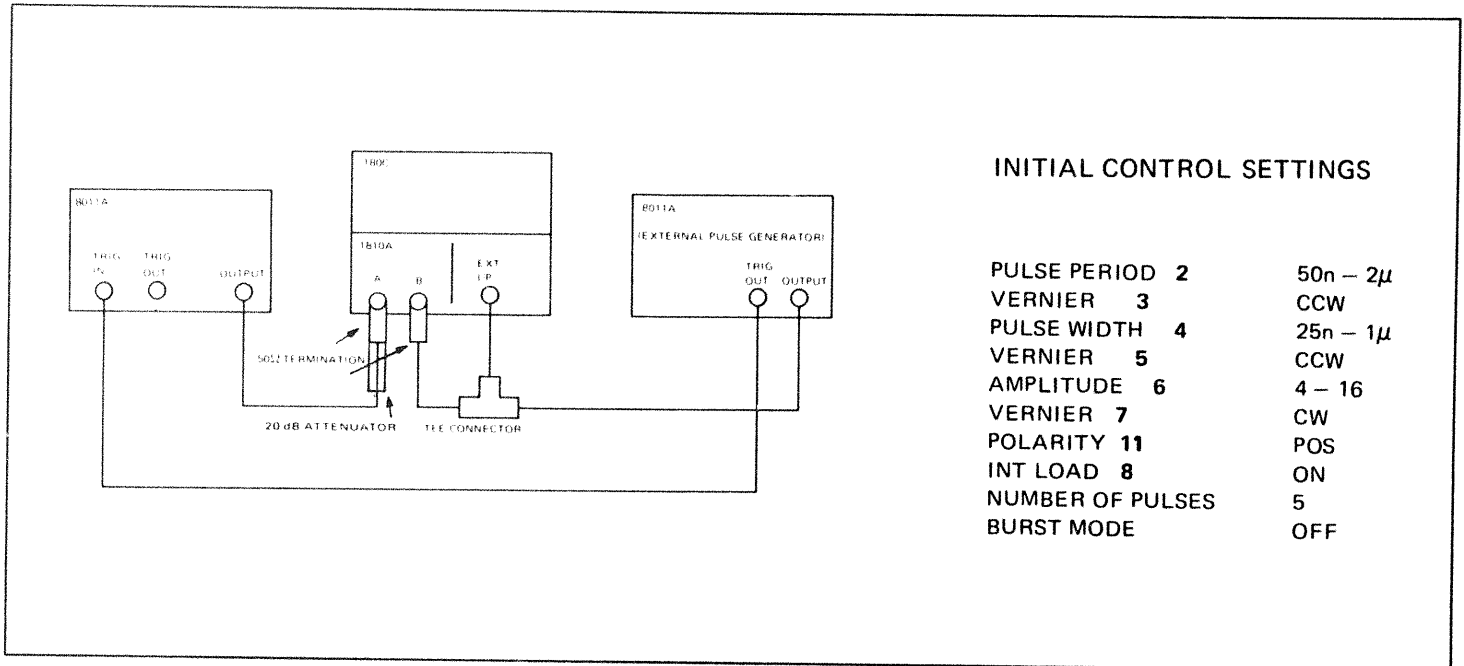

STEP INSTRUCTIONS

RESULTS

1 Set rep. rate of external signal to 2 MHz:

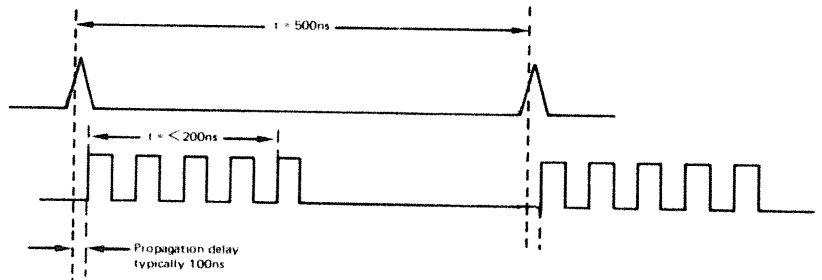

2 Select BURST MODE and observe pulses on the oscilloscope

CAUTION

Output power when 4-16 V range selected can destroy an ordinary 50 ohm load. Use a 20 dB power attenuator or a 50 ohm power termination.

Table 5-18. Adjustment Procedure: Power Supplies

INITIAL CONTROL SETTINGS

PULSE PERIOD	2	EXT
VERNIER	3	CW
PULSE WIDTH	4	1 μ - 50 μ
VERNIER	5	CCW
AMPLITUDE	6	1 - 4
VERNIER	7	CW
POLARITY	11	SYMM
INT LOAD	8	ON
BURST MODE		OFF
(if fitted)		

STEP	INSTRUCTIONS	ADJUST	RESULTS
1	The following measurement are with respect to zero volts using a digital voltmeter.		
2	Measure voltage at the +14V test point	A1R125	+14V \pm 100mV
3	Measure voltage at the -14V test point	A1R128	-14V \pm 100mV
4	If the Burst option (001) is fitted measure voltage at the +5V test pin on assembly 1		+5V \pm 200mV
5	The following measurements are with respect to zero volts using an AC voltmeter.		
6	Measure the ripple on the following supplies		
	+14V		<1mV rms
	-14V		<1mV rms
	+5V		<1mV rms

Table 5-19. Adjustment Procedure — Base Line

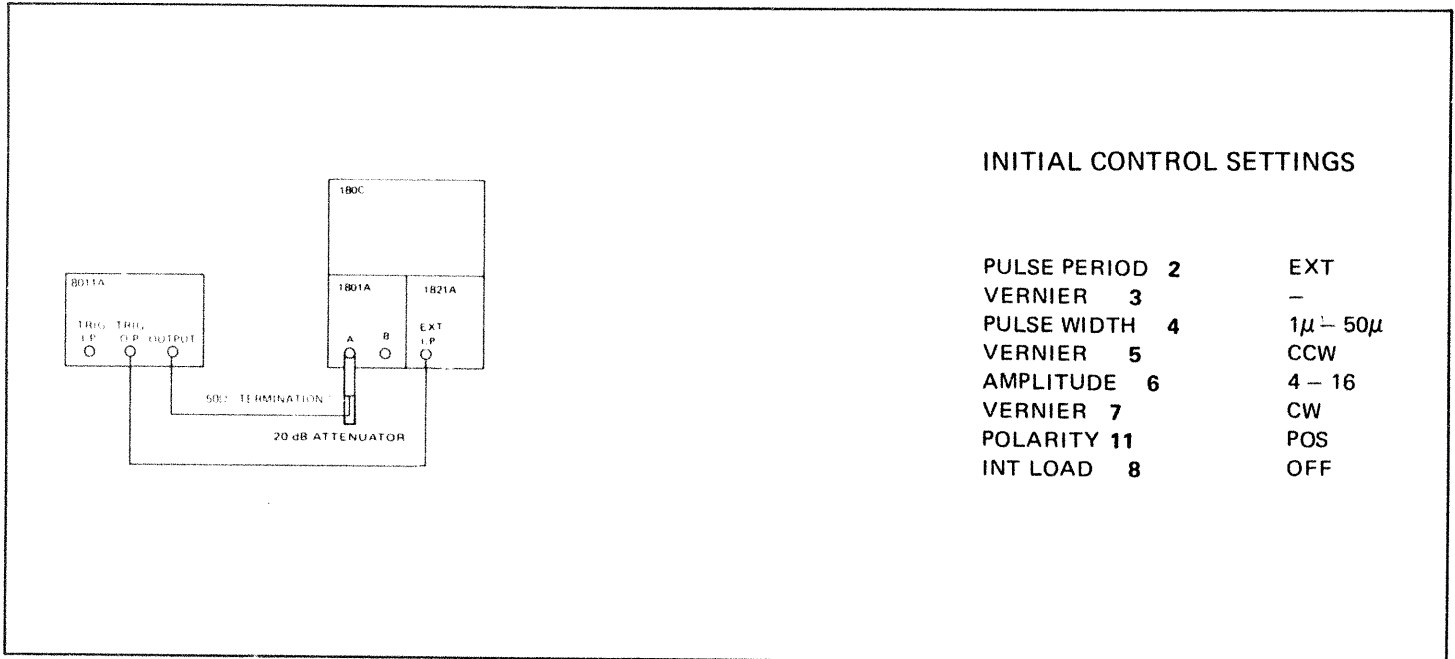
**STEP INSTRUCTIONS**

- 1 With the oscilloscope set to Ground, center the trace on the graticule.
- 2 Switch to DC operation and check that the pulse base remains center of the graticule.
- 3 If necessary, adjust R81 accordingly.
- 4 Select NEG on the 8011A.
- 5 Repeat step 2.
- 6 If necessary, adjust R84 accordingly.

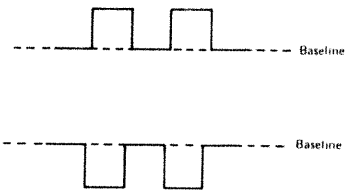
**CAUTION**

Output power when 4–16 V range selected can destroy an ordinary 50 ohm load. Use a 20 dB power attenuator or a 50 ohm power termination.

Table 5-20. Adjustment Procedure-Amplitude

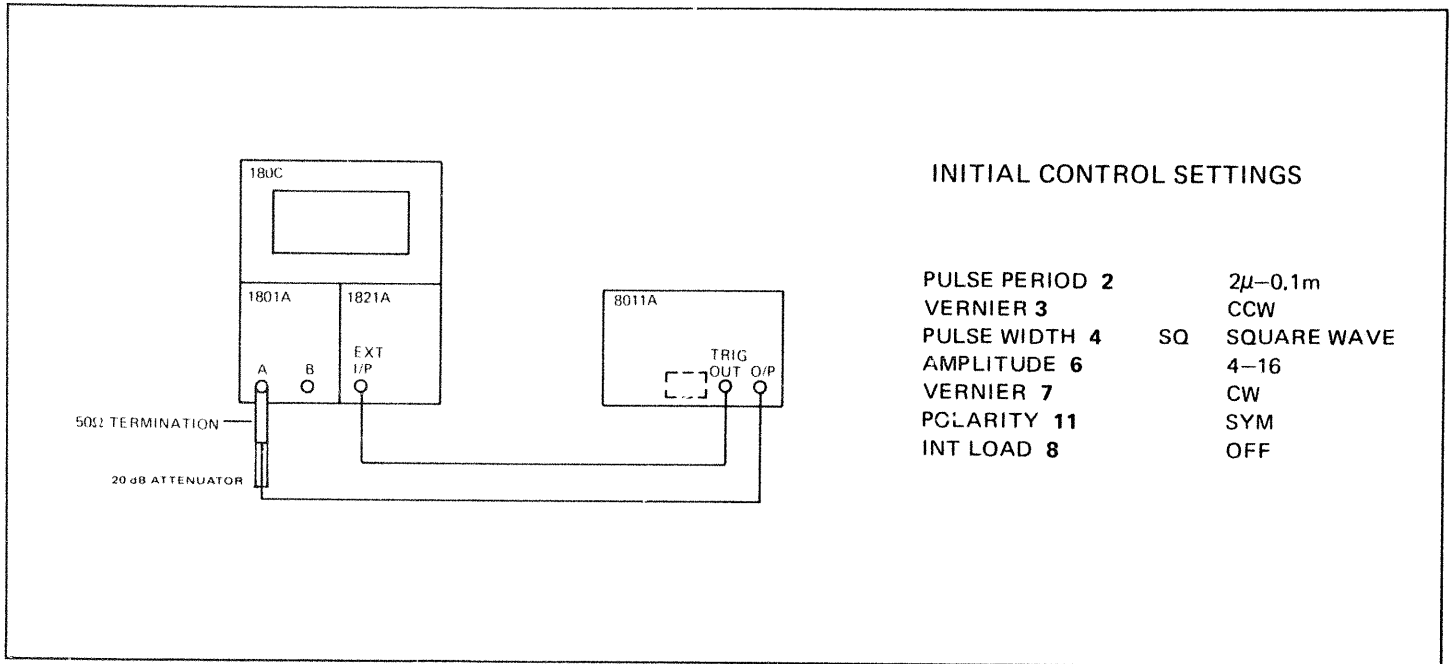

STEP	INSTRUCTIONS
1	With the oscilloscope set to ground, center the trace on the graticule.
2	Adjust A1R131 for a positive amplitude of 8.1 V
3	Adjust A1R133 for a negative amplitude of 8.1 V
4	Re-check Base Line Table 5-19

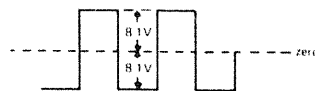
**CAUTION**

Output power when 4-16 V range selected can destroy an ordinary 50 ohm load. Use a 20 dB power attenuator or a 50 ohm power termination.

Figure 5-1. Assembly 1, Assembly 2 – Troubleshooting Aid



Q6/B

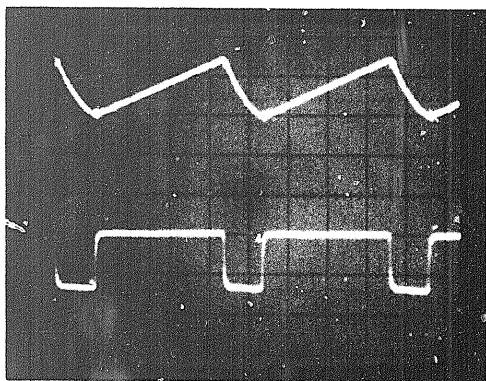

+ 6.5V
+ 3.5V
2V/div



Q5/B

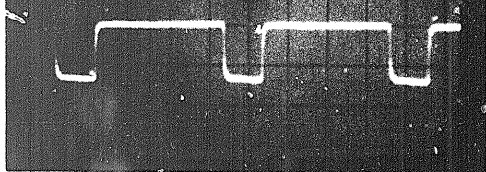

+ 6.4V
+ 3.6V
2V/div

0.5μs/Div



U4/B

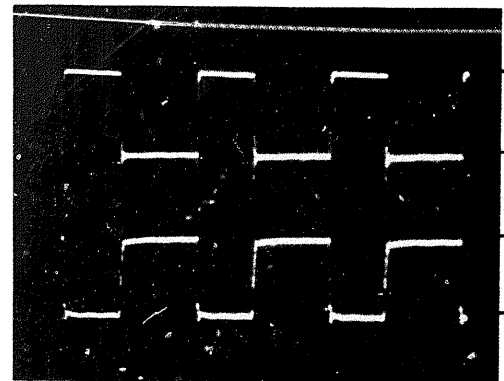

-1V
2V/div
-5V



U2/B

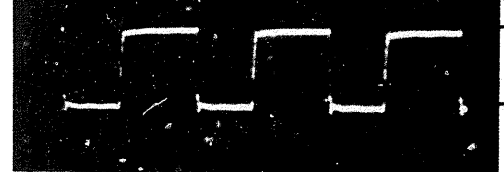

-1V
2V/div
-5V

0.5μs/Div



Q12/C

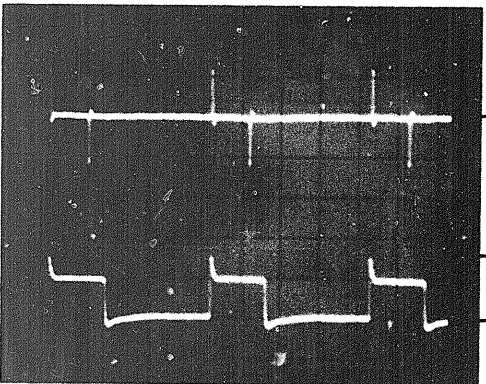

0V
2V/div



Q17/B

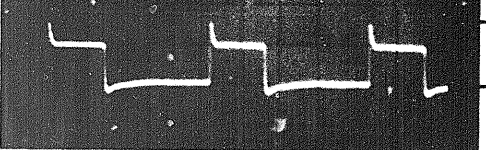

-3V
-10V
5V/div

0.5μs/Div



Q36/B

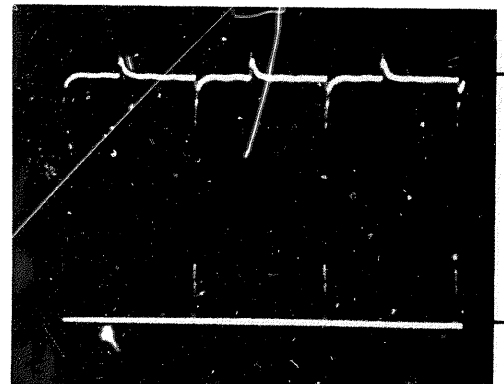

+ 14V
2V/div
0V



Trigger Output

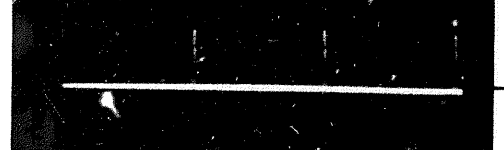

0V
2V/div

0.5μs/Div



Q18/B

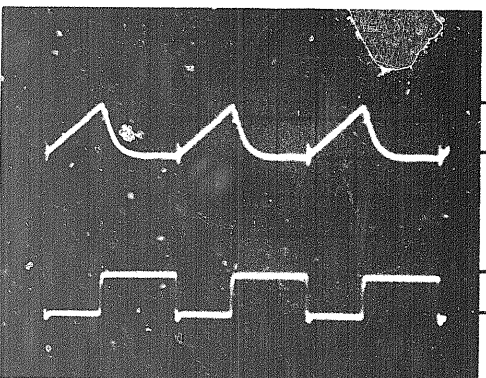

-6.2V
-9V
2V/div



Q17/C



0V
-5V
5V/div

0.5μs/Div



Q24/B

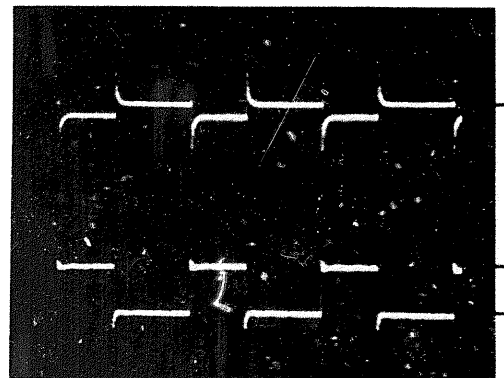

-4.4V
2V/div
0V



L2, Q25/B



+ 11.3V
+ 9V
2V/div

0.5μs/Div



U2/6

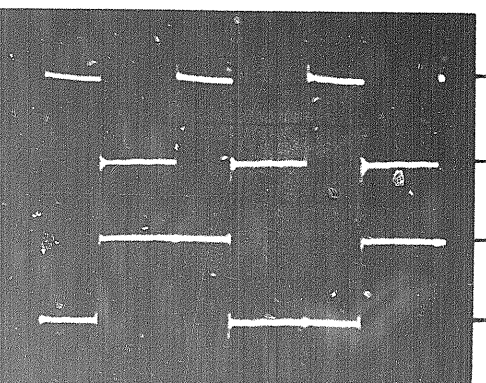

-1V
2V/div
-5V



U3/8

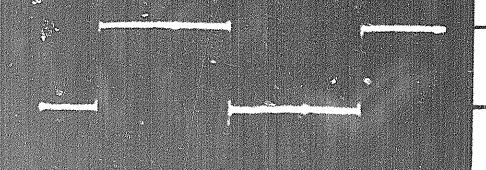

-1V
2V/div
-5V

0.5μs/Div



L3, Q26/B

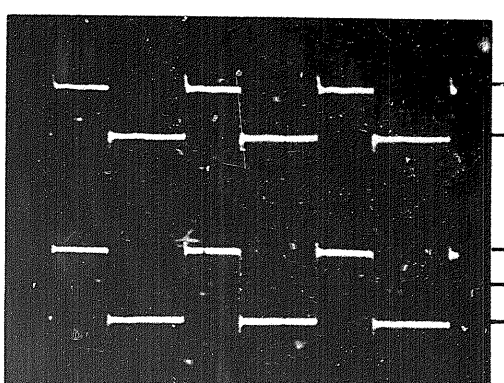

-9V
-11.3V
2V/div



Q28/C, Q30/C

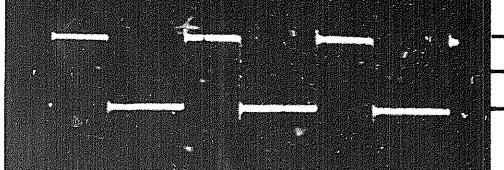

+ 4.1V
0V
-4.1V
5V/div

0.5μs/Div

17

Trigger Input

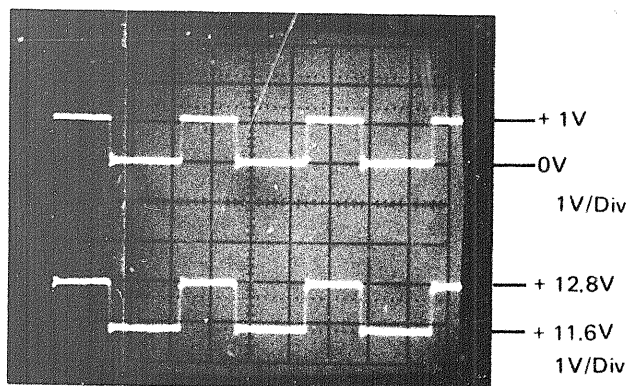

0.5µs/Div

18

Q4/B

31

R26,U1/2

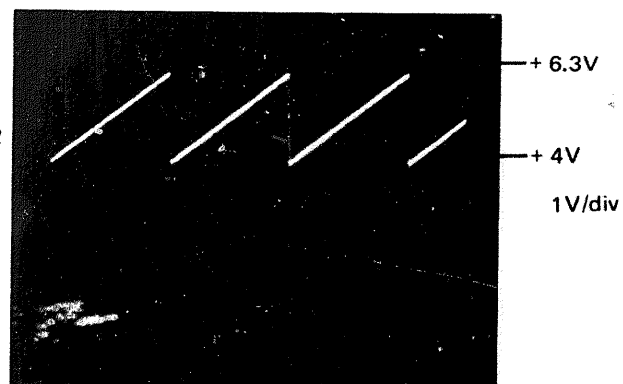

20ms/Div

19

Q7/B

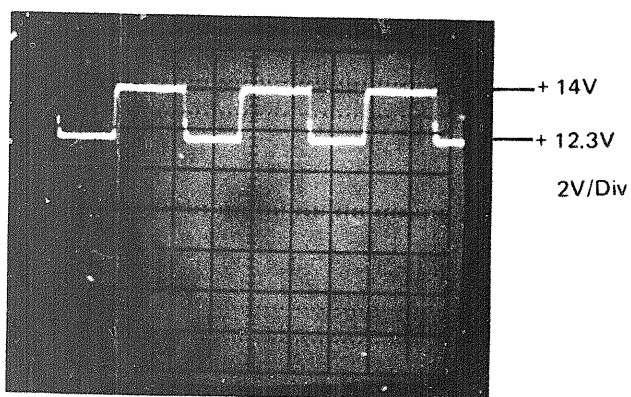

0.5µs/Div

28

Output Signal

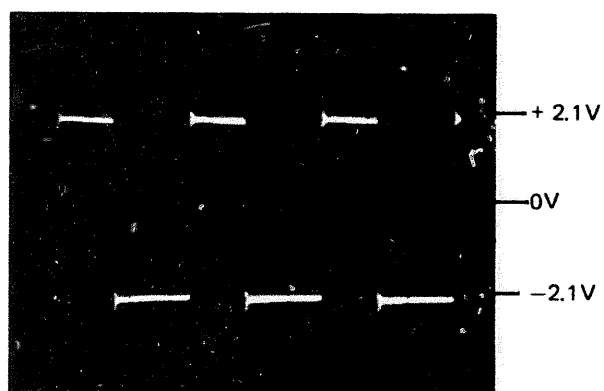

0.5µs/Div

20

Q5/B

25

Q12/C

Burst output

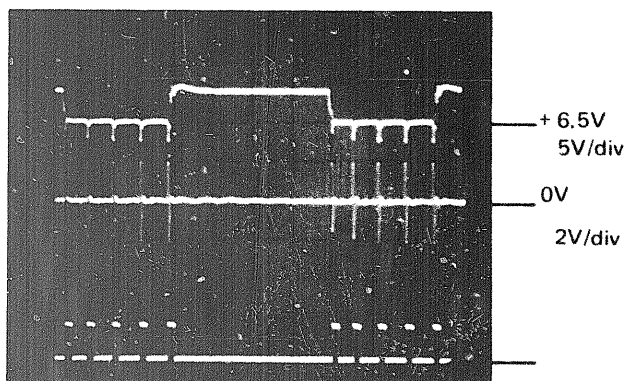

0.5µs/Div

29

R28/U1/1

30

U1/7, Q11/B

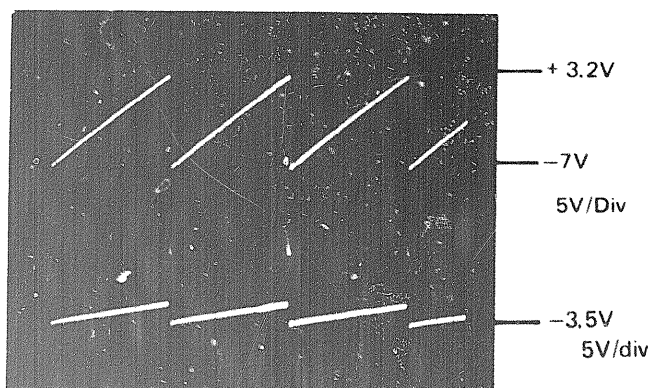

20ms/Div

Table 5-21. Troubleshooting Procedures

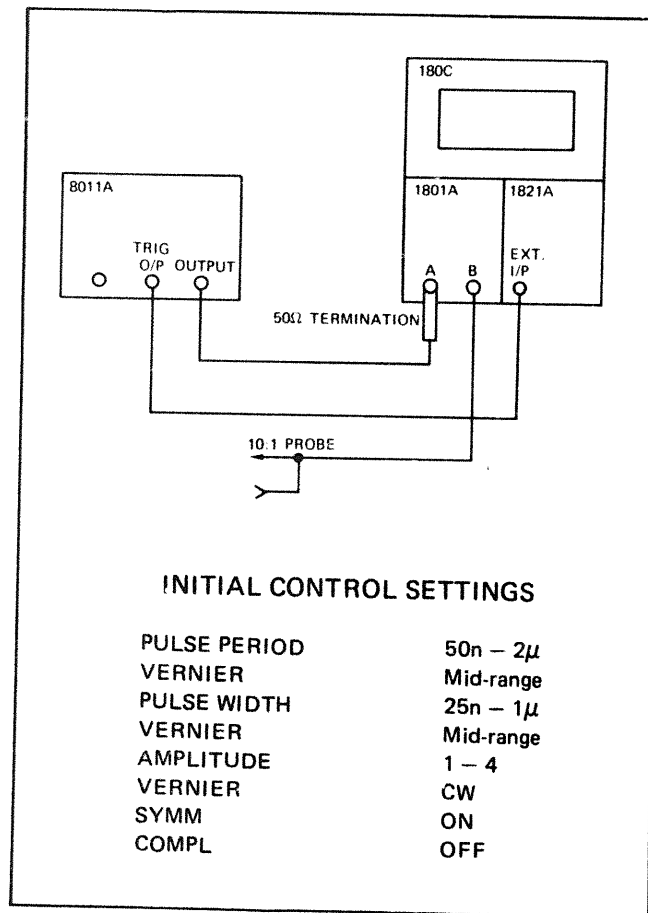

- | STEP | INSTRUCTIONS |
|------|-----------------------------------------------------------------------------------------------|
| 1. | Set the oscilloscope as follows:
EXT TRIGGER
0.5μs/Div |
| 2. | Start the troubleshooting procedure by checking all functions |
| 3. | For Burst troubleshooting see page 6-23 |
| 4. | For checking the EXT Function apply a Pulse Generator with the same settings and 1V Amplitude |
| 5. | The illustrated waveforms and voltages can be readily located by referring to Figure 5-1. |

Note: All voltages are referenced to floating ground.

Table 5-21. cont'd.

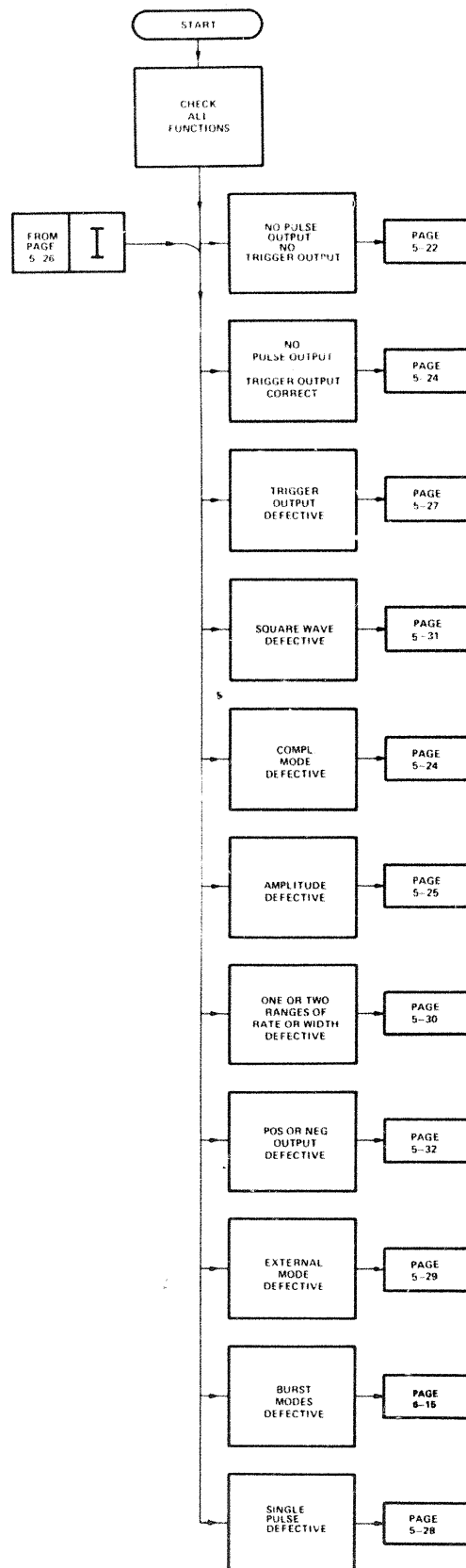
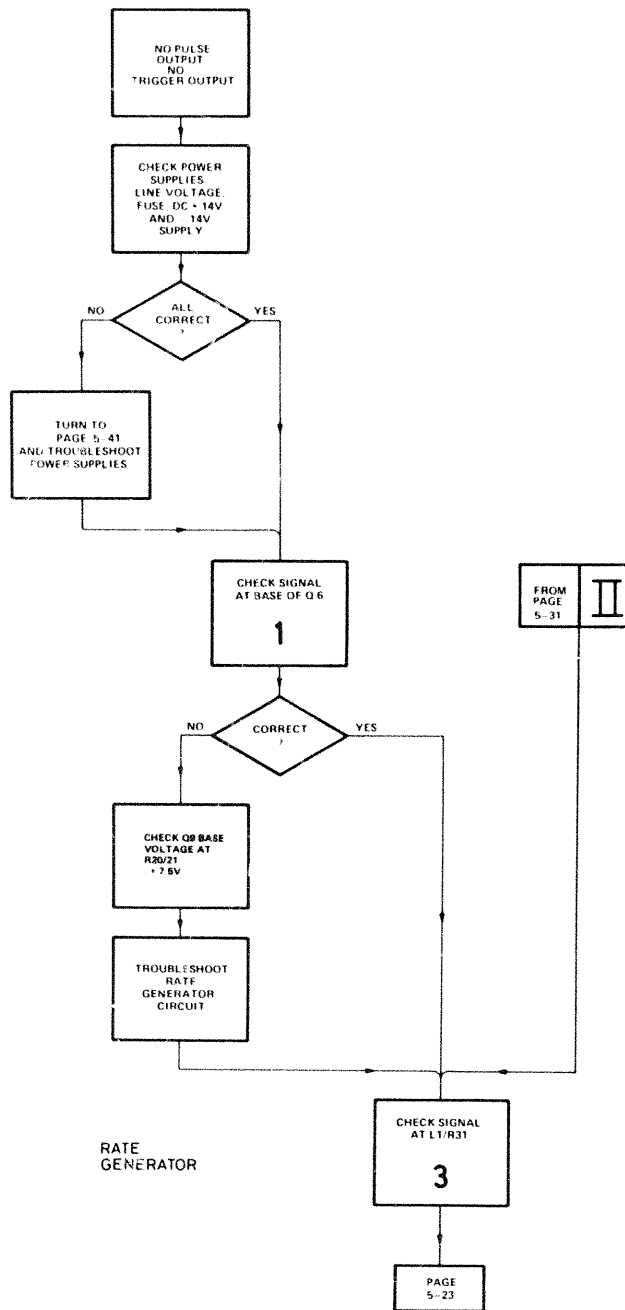
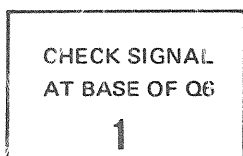

Table 5-21. cont'd.



Numbers in the boxes identify waveforms illustrated in Figure 5-1. For example



the signal at the base of Q6 is to be found at photograph 1 on Figure 5-1.

Table 5-21. cont'd.

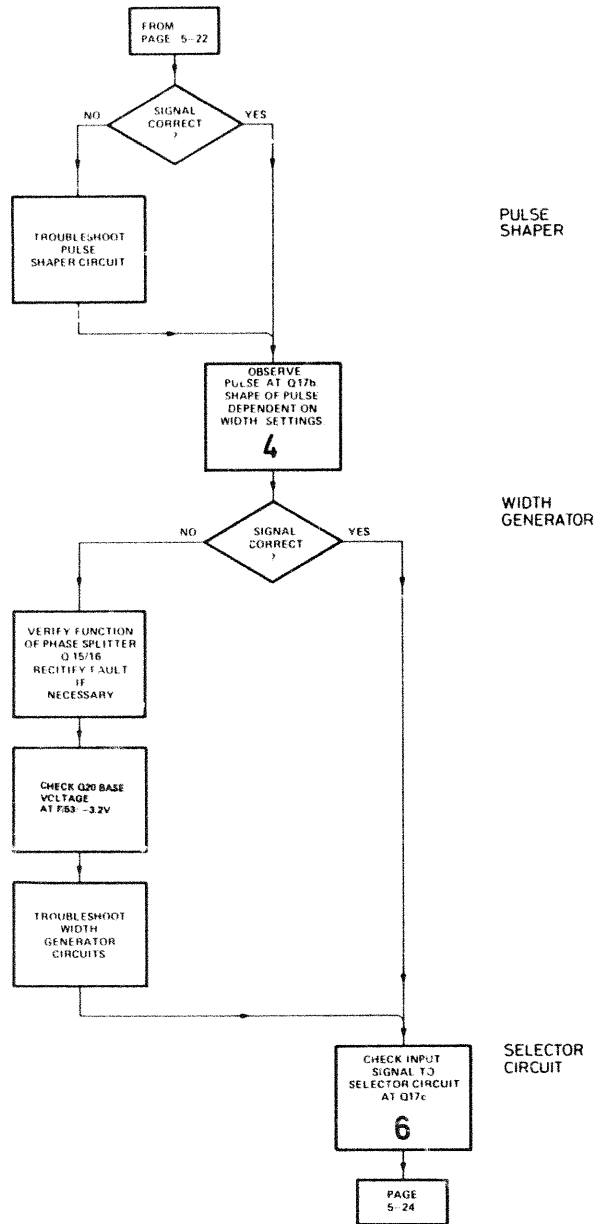
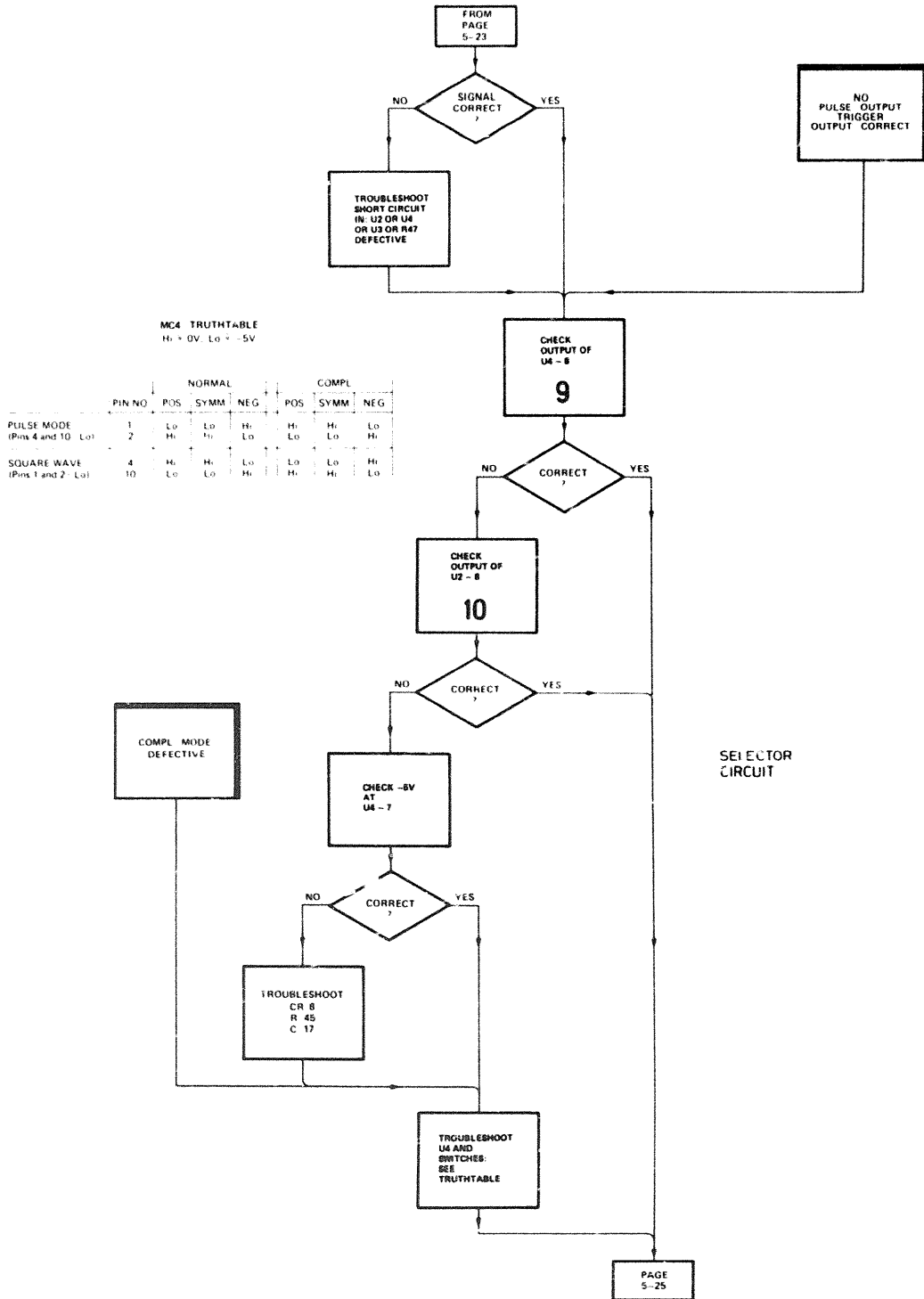

Table 5-21. cont'd.



MC4 TRUTHTABLE
Hi = 0V, Lo = -5V

	PIN NO	NORMAL			COMPL		
		POS	SYMM	NEG	POS	SYMM	NEG
PULSE MODE (Pins 4 and 10)	1	Lo	Lo	Hi	Hi	Lo	Lo
	2	Hi	Hi	Lo	Lo	Hi	Hi
SQUARE WAVE (Pins 1 and 2)	4	Hi	Hi	Lo	Lo	Hi	Hi
	10	Lo	Lo	Hi	Hi	Lo	Lo

SELECTOR
CIRCUIT

Table 5-21. cont'd.

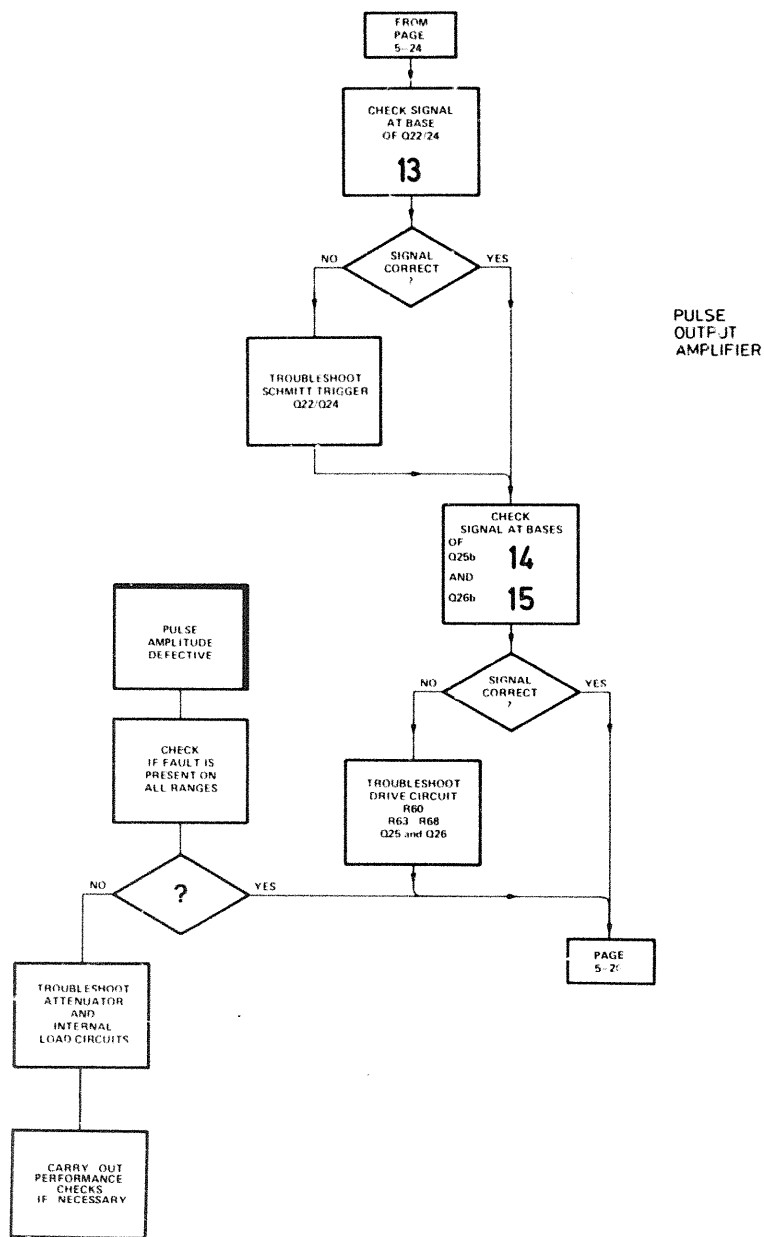

Table 5-21. cont'd.

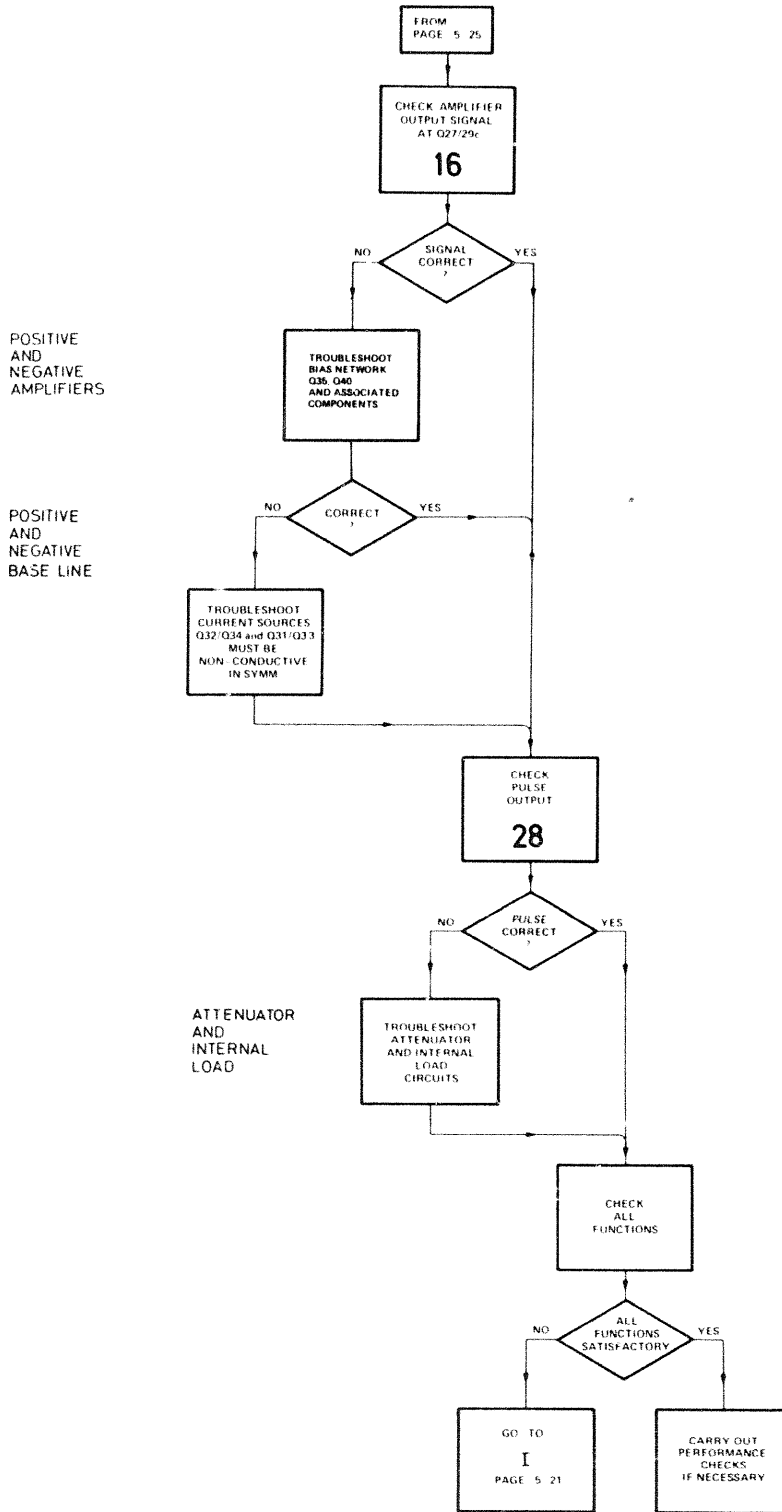
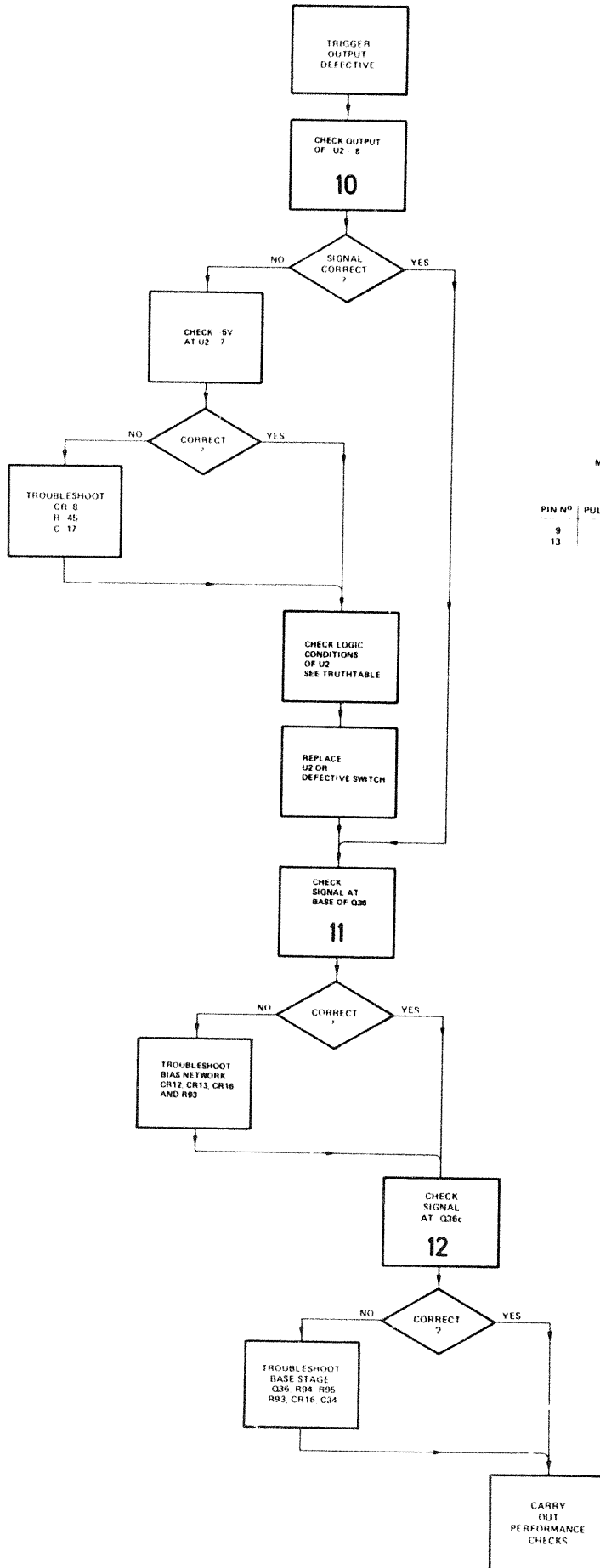

Table 5-21. cont'd



MC 2 TRUTHTABLE
Hi: 0V, LO: 5V

PIN NO	PULSE MODE	SQUARE WAVE
9	Lo	Hi
13	Hi	Lo

Table 5-21. cont'd.

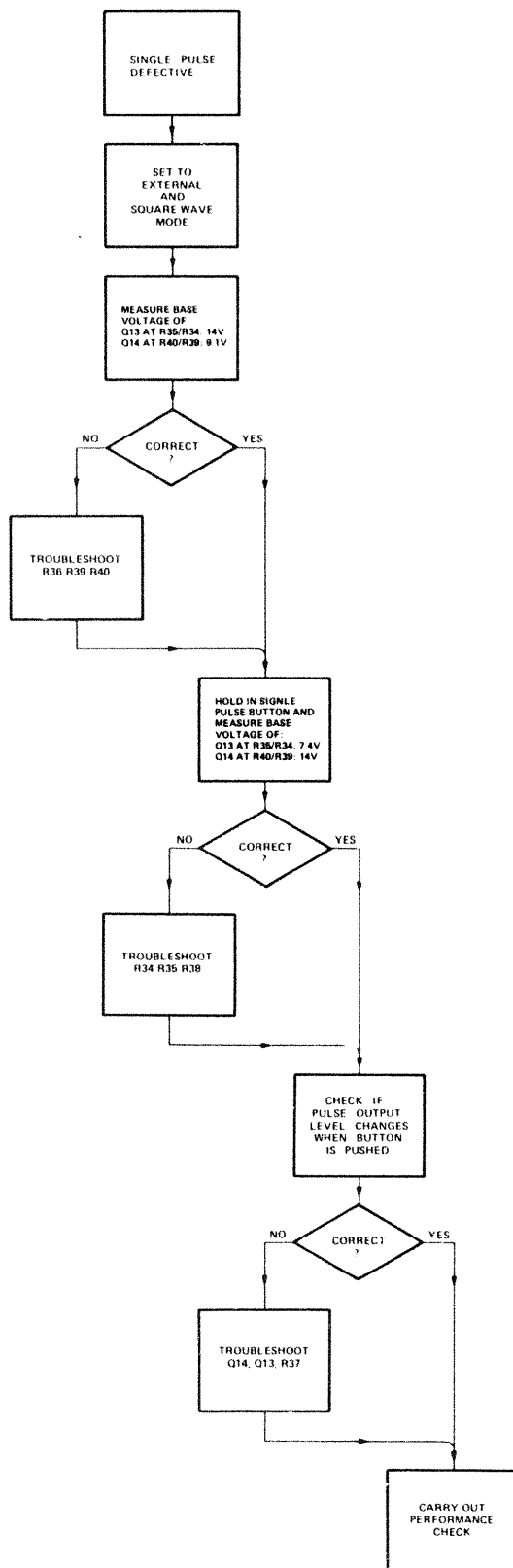

Table 5-21. cont'd.

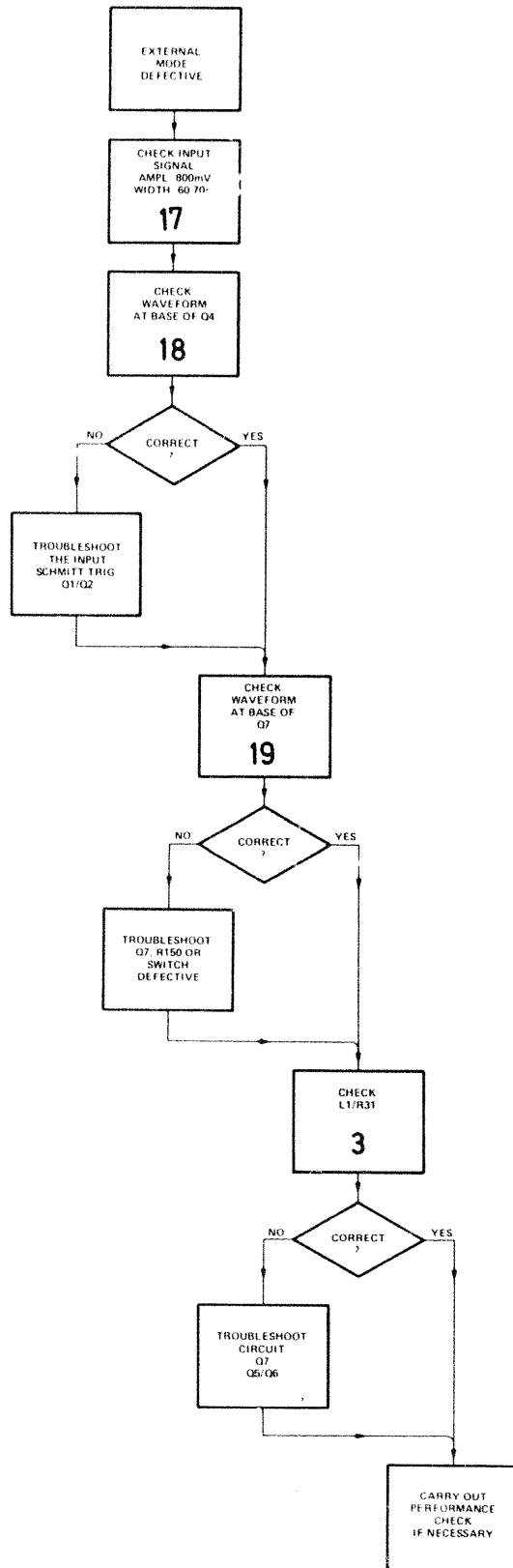

Table 5-21. cont'd.

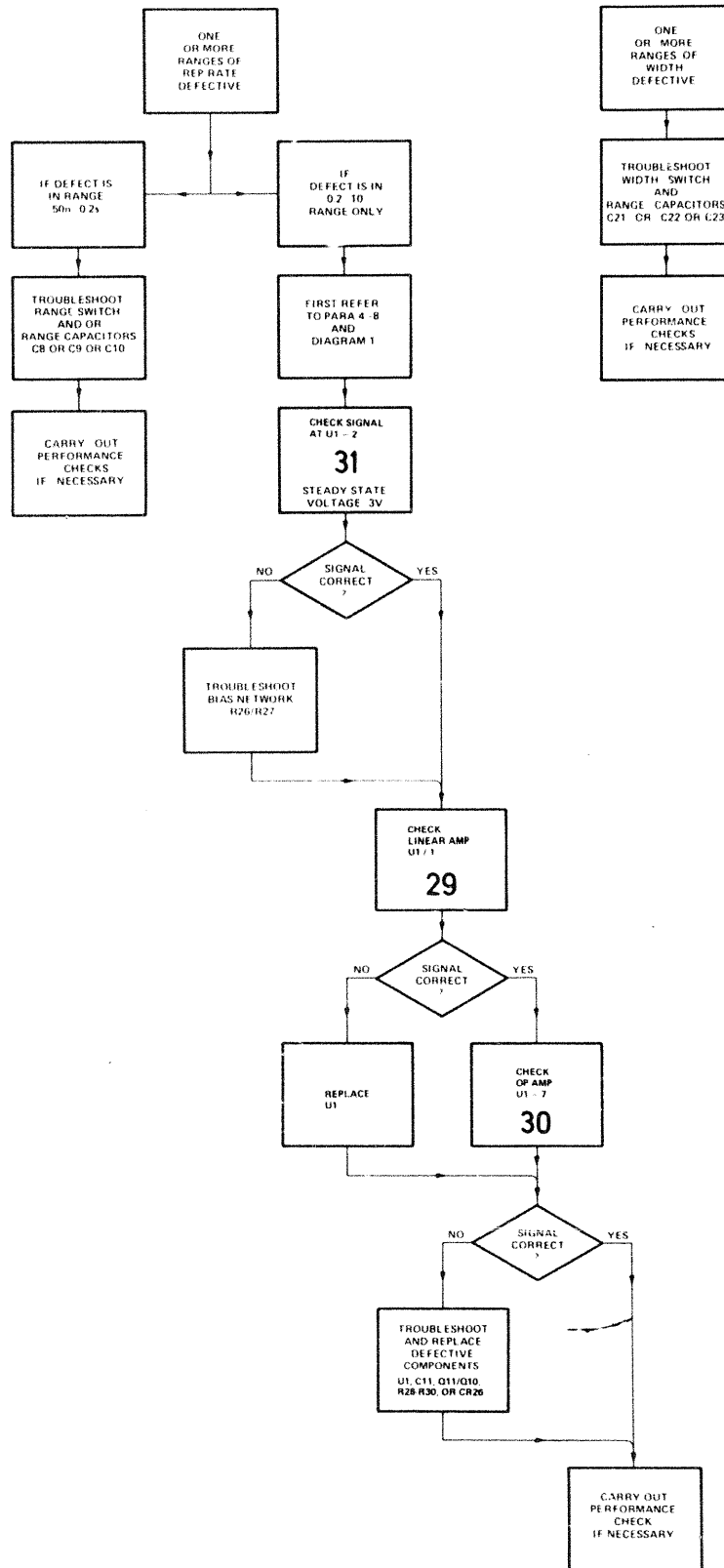

Table 5-21. cont'd.

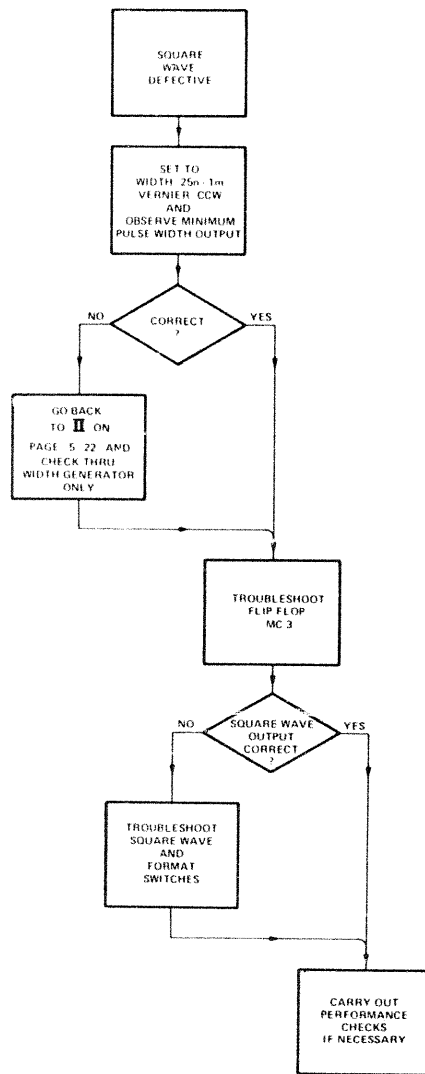

Table 5-21. cont'd.

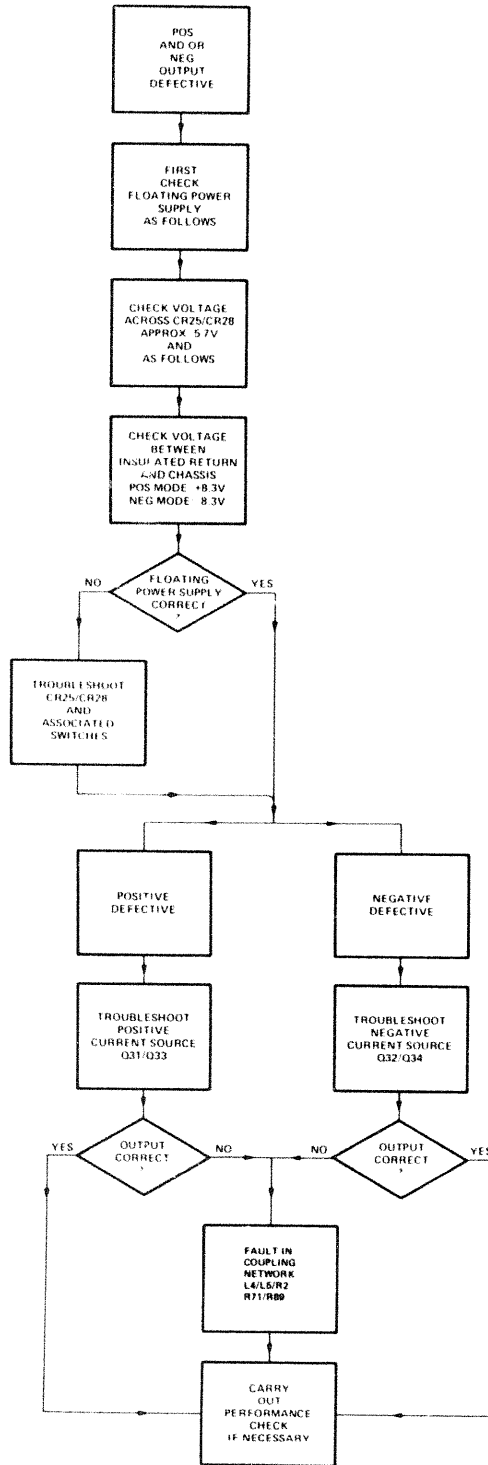

Table 5-21. cont'd.

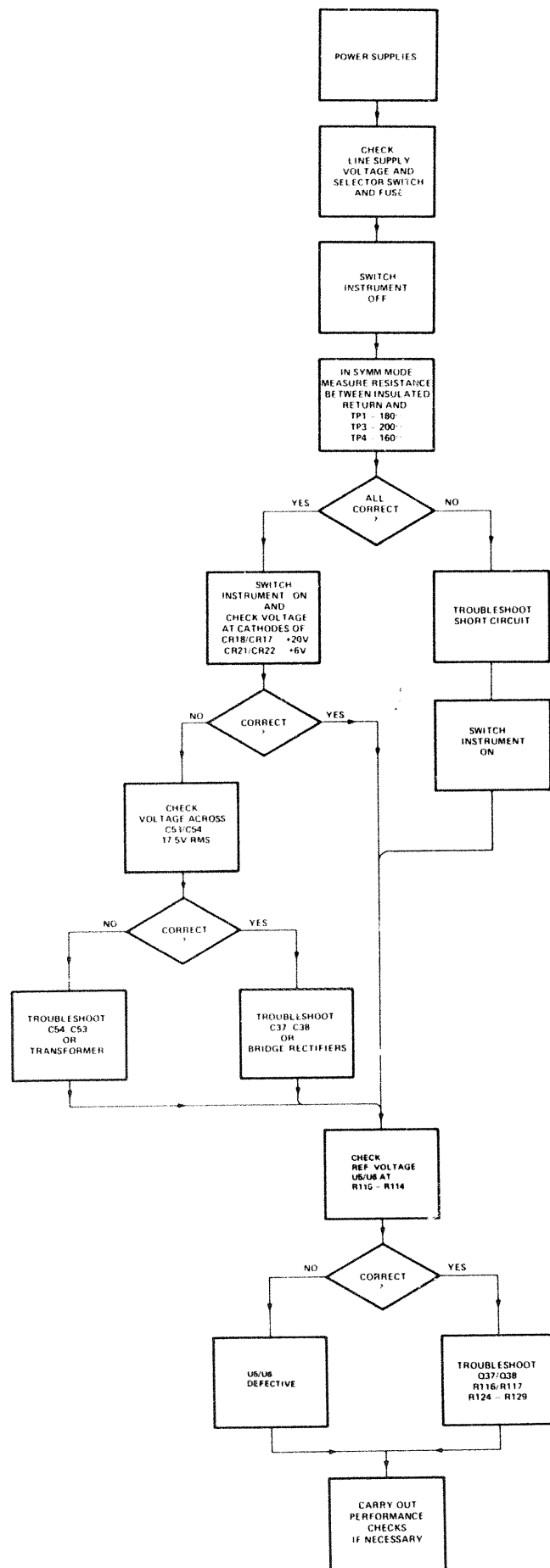

Table 5-22. Performance Test Record

Hewlett-Packard Company Model 8011A Pulse Generator Serial Number			Tested by		
			Date		
Table No.	Test Description		Results		
			Min	Actual	Max
5-2	Repetition Rate				
	50n - 2μ	CCW	20MHz	_____	500kHz
		CW		_____	
	2μ - 0.1m	CCW	500kHz	_____	10kHz
		CW		_____	
	0.1m - 5m	CCW	10kHz	_____	200Hz
		CW		_____	
5m - 0.2	CCW	200ms	_____	5ms	
	CW		_____		
0.2 - 10	CCW	10s	_____	200ms	
		CW			
5-3	Manual Trigger Satisfactory			Yes/No.	
5-4	Square Wave				
	50m - 2μ		10MHz	_____	10ms 400ms
	2μ - 0.1m		250kHz	_____	
	0.1m - 5m		5kHz	_____	
	5m - 0.2			_____	
0.2 - 10			_____		
5-5	Single Burst (Option 001 only) Satisfactory			Yes/No	
5-6	Pulse Width				
	25n - 1μ	CCW		_____	25ns
		CW	1μs	_____	1μs
	1μ - 50 μ	CCW	50μs	_____	50μs
		CW	2.5ms	_____	2.5ms
	50μ - 2.5m	CCW		_____	
	CW		_____		
2.5m - 0.1	CCW		_____		
		CW			
			0.1s		
5-7	Duty Cycle				
	1μ - 50μ		50 %	_____	
	50μ - 2.5m		50 %	_____	
	2.5m - 0.1		50 %	_____	
5-8	Pulse Period Jitter Jitter			_____	1μs (0.1% + 50 ps)

Table 5-22. (cont'd.) Performance Test Record

Hewlett-Packard Company Model 8011A Pulse Generator Serial Number		Tested by Date		
Table No.	Test Description	Results		
		Min	Actual	Max
5-9	Pulse Width Jitter Jitter		_____	1 μ s (0.1% + 50 ps)
5-10	External Trigger Satisfactory		Yes/No	
5-11	HF Triggering Satisfactory		Yes/No	
5-12	Minimum Width Pos Neg		_____ _____	25ns 25ns
5-13	Preshoot, Overshoot, Ringing Int load on Int load off		_____ _____	5 % 10 %
5-14	Transition Times Leading edge Trailing edge		_____ _____	10ns 10ns
5-15	Output Amplitude 4-16V CW (Int load off) (Int load on) CCW (Int load on) 1-4V CW CCW 0.25-1V CW CCW	16V 8V 4V 1V	_____ _____ _____ _____ _____ _____	4V 1V 0.25V
5-16	Trigger Output Amplitude Width	1V 10ns	_____ _____	30ns
5-17	Repetitive Burst Satisfactory		Yes/No	
5-23	Safety Check Interior inspection Resistance cabinet to power plug gnd Resistance cabinet to line Line fuse Line fuse safety cover Heatsinks secure	2M Ω	_____ _____ _____ <input type="checkbox"/> <input type="checkbox"/> <input type="checkbox"/>	1 Ω

Table 5-23

Safety Check

1. Disconnect power cord from line. Visually inspect interior for any sign of abnormal internally generated heat, such as discolored printed circuit boards or components, damaged insulation, or evidence of arcing. Determine cause and remedy.
2. Check resistance from cabinet to ground pin on power plug with suitable ohmmeter. The reading must be less than one ohm. Flex the power cord while making the measurement to detect any intermittent discontinuity. Check internal ground connections on boards and frame. Also check resistance of any front or rear panel ground terminals marked .
3. Check resistance from cabinet to line and neutral (tied together) with the power switch on and the power source disconnected. The minimum acceptable resistance is two megohms. Replace any component which results in a failure or refer to production Memo or Service Note issued by product division for alternate action.
4. Check line fuse to verify that the proper value is installed.
5. Check that the plastic safety cover for the line fuse is installed.
6. Check that all coaxial and flat cables inside are properly connected. Check that all boards and the heatsink on the chassis are properly connected.
7. Inform Hewlett-Packard (internally, the responsible product division) of any repeated failures in the above tests or any other safety features.

6-1 INTRODUCTION

6-2 This section contains the circuits, component location diagrams and the lists of replaceable parts. Waveforms shown with the circuits are included for guidance only and failure to observe identical results should not be automatically taken as indication of a fault.

6-3 ORDERING INFORMATION**6-4 General**

6-5 The replaceable parts tables list parts in alphanumerical order of their reference designators and indicate the description and HP stock number of each part, together with any applicable notes.

6-6 To order a replacement part, address order of enquiry either to your authorized Hewlett-Packard sales representative or to:

CUSTOMER SERVICE
Hewlett-Packard Company,
333 Logue Avenue,
Mountain View, California 94040

or, in Wester Europe, to:

Hewlett-Packard (Schweiz) SA
Rue du Bois-du-Lan 7
1217 Meyrin 2
Geneva

6-7 Specify the following information for each part:

- a) Model and complete serial number of instrument.
- b) Hewlett-Packard stock number.
- c) Circuit reference stock number.
- d) Description.







To order a part not listed, give a complete description of the part and include its function and location.

Table 6--1. Reference Designators

A	= assembly	P	= plug
B	= motor	Q	= transistor
BT	= battery	R	= resistor
C	= capacitor	RT	= thermistor
CP	= coupler	S	= switch
CR	= diode	T	= transformer
DL	= delay line	TB	= terminal board
DS	= lamp	U	= micro-circuit
F	= fuse	V	= vacuum, tube, neon bulb, photocell, etc.
FL	= filter	VR	= voltage regulator
HR	= heater	W	= cable
J	= jack	X	= socket
K	= relay	Y	= crystal
L	= inductor	TP	= test point
M	= meter		

Table 6-2. Diagram Notes

Resistance in ohms, capacitance in microfarads, inductance in microhenries unless other noted
 All voltages are referenced to floating ground.

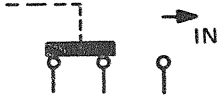
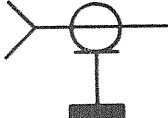
P/O	Part of
*	denotes a factory selected value. Values shown are typical.
	Screwdriver adjustment
	Encloses front panel nomenclature
	Encloses rear panel nomenclature
	Zener diode
	Chassis ground (0 volts)
	Floating ground
— 901 —	Wire colour e.g. white, black, brown.
	Part of push-button switch
	Signal input/output connectors

6-8 CIRCUIT DIAGRAM WAVEFORMS

6-9 Waveforms shown on the circuit diagrams 1 to 3 were taken with the 8011A set as follows, changes in time base and sensitivity are noted on the waveform concerned:

PULSE PERIOD	50n - .2 μ
VERNIER	Mid-range
PULSE WIDTH	25n - 1 μ
VERNIER	Mid-range
AMPLITUDE	1V - 4V
VERNIER	CW
SYM	ON
COMPL	OFF
BURST	OFF

To obtain waveforms shown on diagram 5 select BURST MODE.

Table 6-3. List of Manufacturers Codes (to be used in conjunction with Replaceable Parts Lists)

MFR. NO.	MANUFACTURER NAME	ADDRESS	ZIP CODE
FR009	GAM	MEALX FRANCE	77
00501	ILLUMINATED PRODUCTS INC	ANAHEIM CA	92803
01221	ALLEN BRADLEY CO	MILWAUKEE WI	53212
01295	TEXAS INSTR INC SEMICOND CMPNT DIV	DALLAS TX	75231
02114	FERROXCUBE CORP	SAUGERTIES NY	12477
04713	MOTOROLA SEMICONDUCTOR PRODUCTS	PHOENIX AZ	85008
07263	FAIRCHILD SEMICONDUCTOR DIV	MOUNTAIN VIEW CA	94040
11502	TRW INC BOONE DIV	BOONE NC	28607
12697	CLARSTAT MFG CO INC	DOVER NH	03620
16249	CORNING GL WK ELEC CMPNT DIV	RALEIGH NC	27604
19701	MEPCO/ELECTRA CORP	MINERAL WELLS TX	76067
23880	STANFORD APPLIED ENGINEERING INC	SANTA CLARA CA	95050
24226	GOWANDA ELECTRONICS CORP	GOWANDA NY	14070
24546	CORNING GLASS WORKS (BRADFORD)	BRADFORD PA	16701
27167	CORNING GLASS WORKS (WILMINGTON)	WILMINGTON NC	28401
28480	HEWLETT-PACKARD CO CORPORATE HW	PALO ALTO CA	94304
56289	SPRAGUE ELECTRIC CO	NORTH ADAMS MA	01247
71400	BUSSMAN MFG DIV OF MCGRAW-EDISON CO	ST LOUIS MO	63017
72136	ELECTRO MOTIVE MFG CO INC	WILLIMANTIC CT	06226
75915	LITTELFUSE INC	DES PLAINES IL	60016
76381	3M COMPANY	ST. PAUL MN	55101
90949	AMPHENDL SALES DIV OF BUNKER-RAMO	HAZELWOOD MO	63042
91637	DALE ELECTRONICS INC	COLUMBUS NE	68601

NOTE 1
OPTION 001 ONLY

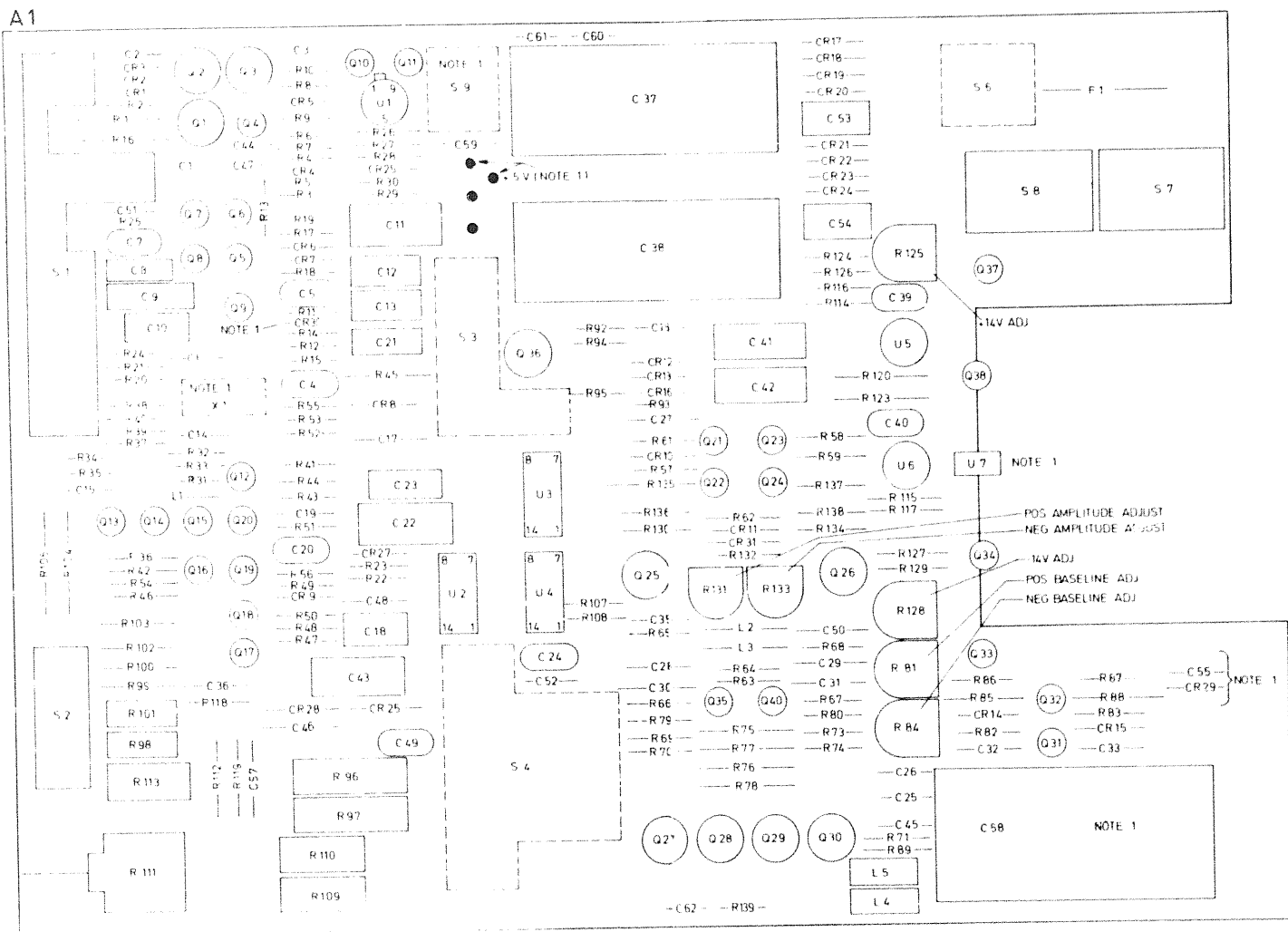
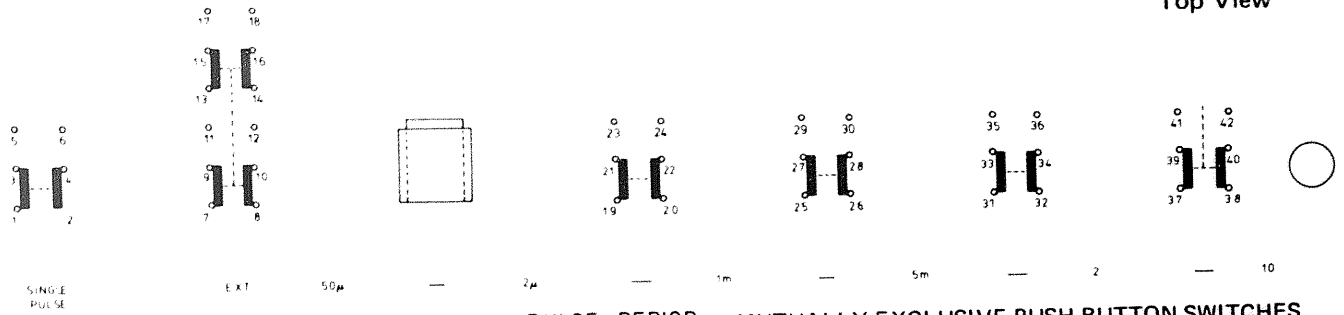

Table 6-4. Frame (Standard) Replacable Parts List

Reference Designation	HP Part Number	Qty	Description	Mfr Code	Mfr Part Number
R1	08011-66501		BOARD ASSEMBLY, PULSE GENERATOR	28480	08011-66501
C51	2140-0016	1	LAMP-INCAND T-1 BULB 5V	0050I	11-AS25
F1	2110-0020	1	FUSE .8A 250V SLO-BLO 1.25X.25 UL	71400	MDL 8/10
F1	2110-0340	1	FUSE .4A 250V SLO-BLO 1.25X.25 UL	75915	313.4005
FL1	9100-3121	1	FILTER ELEC 2A (EUROPE)	28480	9100-3121
	1251-2357	1	POWER LINE CONNECTOR (USA)		
J1	1250-0118	3	CONNECTOR-RF BNC FEM SGL HOLE FR	90949	31-2221-1022
J2	1250-0118		CONNECTOR-RF BNC FEM SGL HOLE FR	90949	31-2221-1022
J3	1250-0113		CONNECTOR-RF BNC FEM SGL HOLE FR	90949	31-2221-1022
MP1	0370-1005	2	PERIOD AND WIDTH VERNIER KNOBS	28480	0370-1005
MP2	0370-1097	1	AMPLITUDE VERNIER KNOB	28480	0370-1097
MP3	0370-2486	20	PUSHBUTTON (SOLID GRAY)	28480	0370-2486
MP4	08011-00205	1	PANEL, FRONT	28480	08011-00205
MP5	08011-00202	1	PANEL, REAR	28480	08011-00202
MP6	08011-04101	1	COVER, SAFETY	28480	08011-04101
MP7	5040-1124	1	KNOB, PUSHBUTTON, POWER	28480	5040-1124
MP9	5040-0445	1	FOOT ASSEMBLY	28480	5040-0445
MP10	1460-1300	1	STAND, TILT	28480	1460-1300
MP11	1450-0404	1	LENS, PILOT LIGHT	28480	1450-0404
MP13	08011-43701	1	ROD, POWER SWITCH	28480	08011-43701
MP14	08012-04101	1	COVER ASSEMBLY	28480	08012-04101
MP15	08011-43702	1	ROD, AMPLIFIER SWITCH	28480	08011-43702
R1	2100-2590	2	RESISTOR-VAR CONTROL CC 10K 10% 10CW	12697	SERIES 63M
R2	2100-2590		RESISTOR-VAR CONTROL CC 10K 10% 10CW	12697	SERIES 63M
T1	5080-0973	1	TRANSFORMER, POWER	28480	5080-0973

Top View



PULSE PERIOD MUTUALLY EXCLUSIVE PUSH-BUTTON SWITCHES

S 1

(viewed from above the instrument)

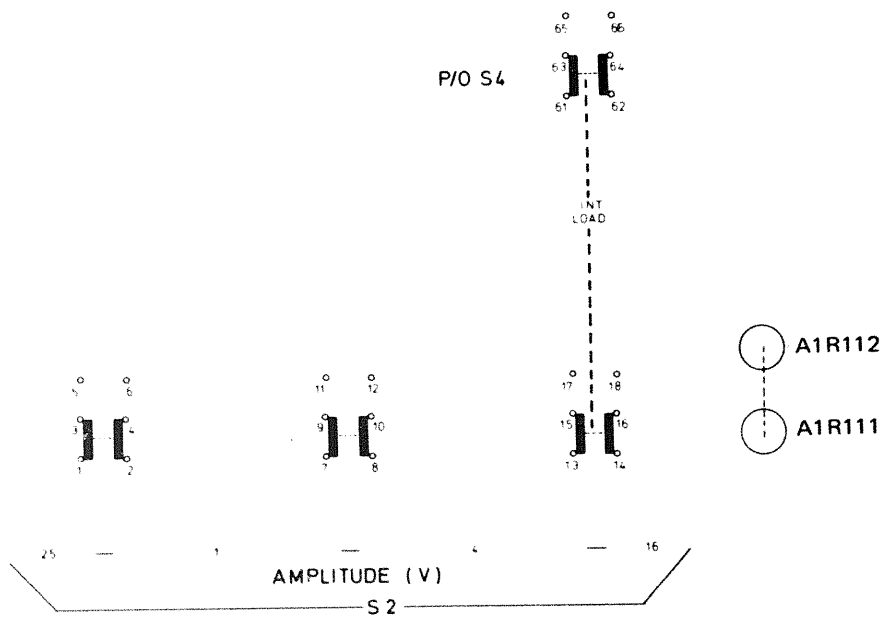

AMPLITUDE (V)

S 2

(viewed from above the instrument)

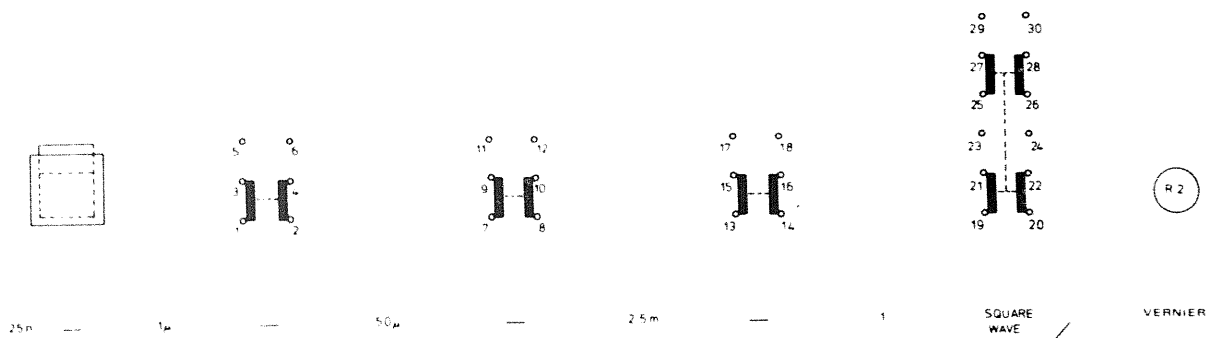

PULSE WIDTH MUTUALLY EXCLUSIVE PUSH-BUTTON SWITCHES

S 3

(viewed from above the instrument)

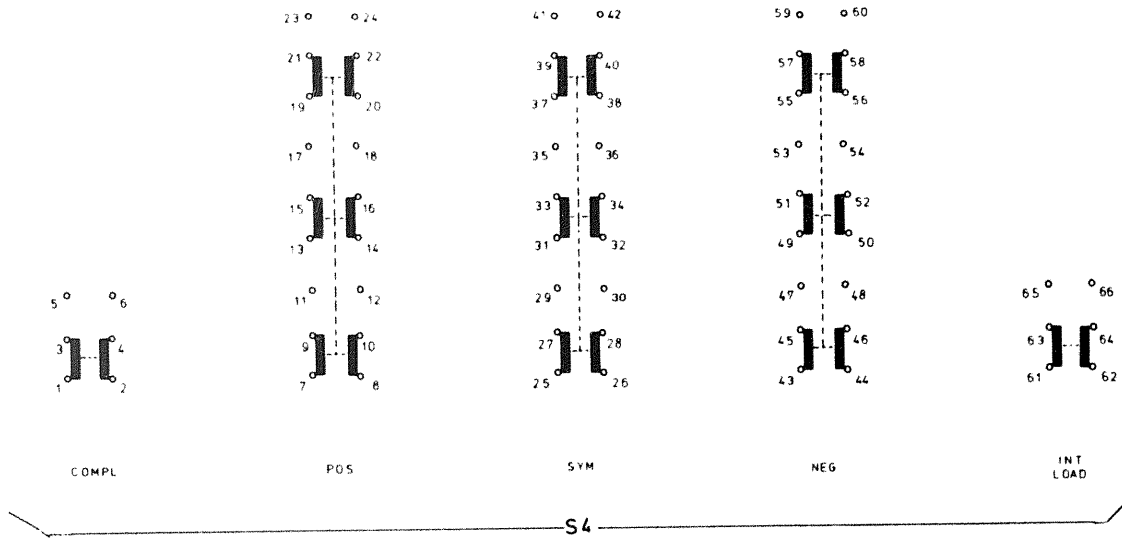

(viewed from above the instrument)

BURST SWITCHES: (OPTION 001)

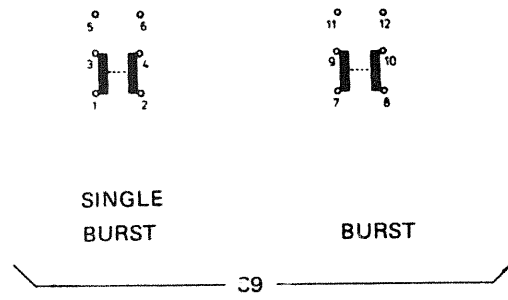

(viewed from above the instrument)

Table 6-5. Board A1 (Standard) Replaceable Parts List

Reference Designation	HP Part Number	Qty	Description	Mfr Code	Mfr Part Number
A1	08011-66501	1	BOARD ASSEMBLY, PULSE GENERATOR	28480	08011-66501
A1C1	0160-2208	2	CAPACITOR-FXD 330PF +-5% 300WVDC MICA	28480	0160-2208
A1C2	0160-4210	16	CAPACITOR-FXD .022UF +-20% 50WVDC POLYE	28480	0160-4210
A1C3	0160-4210		CAPACITOR-FXD .022UF +-20% 50WVDC POLYE	28480	0160-4210
A1C4	0140-0210	1	CAPACITOR-FXD 270PF +-5% 300WVDC MICA	72136	DM15F271J0300WV1CR
A1C5	0160-2150	1	CAPACITOR-FXD 33PF +-5% 300WVDC MICA	28480	0160-2150
A1C6	0160-4210		CAPACITOR-FXD .022UF +-20% 50WVDC POLYE	28480	0160-4210
A1C7	0140-0195	1	CAPACITOR-FXD 130PF +-5% 300WVDC MICA	72136	DM15F131J0300WV1CR
A1C8	0160-3715	1	CAPACITOR-FXD .015UF +-10% 250WVDC MET	28480	0160-3715
A1C9	0160-3725	1	CAPACITOR-FXD .68UF +-10% 40WVDC MET	28480	0160-3725
A1C10	0180-0229	1	CAPACITOR-FXD: 33UF+-10% 10VDC TA-SOLID	56289	150D336X901082
A1C11	0160-3839	1	CAPACITOR-FXD 2.2UF +-10% 40WVDC MET	28480	0160-3839
A1C12	0160-4213	5	CAPACITOR-FXD .1UF +-20% 50WVDC POLYE	28480	0160-4213
A1C13	0160-4213		CAPACITOR-FXD .1UF +-20% 50WVDC POLYE	28480	0160-4213
A1C14	0160-4210		CAPACITOR-FXD .022UF +-20% 50WVDC POLYE	28480	0160-4210
A1C15	0160-4210		CAPACITOR-FXD .022UF +-20% 50WVDC POLYE	28480	0160-4210
A1C16	0160-4210		CAPACITOR-FXD .022UF +-20% 50WVDC POLYE	28480	0160-4210
A1C17	0160-0127	2	CAPACITOR-FXD 1UF +-20% 25WVDC CER	28480	0160-0127
A1C18	0160-4213		CAPACITOR-FXD .1UF +-20% 50WVDC POLYE	28480	0160-4213
A1C19	0160-4210		CAPACITOR-FXD .022UF +-20% 50WVDC POLYE	28480	0160-4210
A1C20	0140-0193	2	CAPACITOR-FXD 82PF +-5% 300WVDC MICA	72136	DM15E820J0300WV1CR
A1C21	0160-3220	1	CAPACITOR-FXD 6800PF +-5% 250WVDC MET	FR009	CKB-68
A1C22	0160-3723	1	CAPACITOR-FXD: 33UF +-10% 40WVDC MET	28480	0160-3723
A1C23	0180-1746	1	CAPACITOR-FXD: 15UF+-10% 20VDC TA-SOLID	56289	150D156X902082
A1C24	0160-2208		CAPACITOR-FXD 330PF +-5% 300WVDC MICA	28480	0160-2208
A1C25	0160-4210		CAPACITOR-FXD .022UF +-20% 50WVDC POLYE	28480	0160-4210
A1C26	0160-4210		CAPACITOR-FXD .022UF +-20% 50WVDC POLYE	28480	0160-4210
A1C27	0140-0193		CAPACITOR-FXD 82PF +-5% 300WVDC MICA	72136	DM15E820J0300WV1CR
A1C28	0160-0174	7	CAPACITOR-FXD .47UF +-80-20% 25WVDC CER	28480	0160-0174
A1C29	0160-0174		CAPACITOR-FXD .47UF +-80-20% 25WVDC CER	28480	0160-0174
A1C30	0160-0174		CAPACITOR-FXD .47UF +-80-20% 25WVDC CER	28480	0160-0174
A1C31	0160-0174		CAPACITOR-FXD .47UF +-80-20% 25WVDC CER	28480	0160-0174
A1C32	0160-4210		CAPACITOR-FXD .022UF +-20% 50WVDC POLYE	28480	0160-4210
A1C33	0160-4210		CAPACITOR-FXD .022UF +-20% 50WVDC POLYE	28480	0160-4210
A1C34	0160-4210		CAPACITOR-FXD .022UF +-20% 50WVDC POLYE	28480	0160-4210
A1C35	0160-2959	2	CAPACITOR-FXD 1000PF +-80-20% 1000WVDC	28480	0160-2959
A1C36	0160-0127		CAPACITOR-FXD 1UF +-20% 25WVDC CER	28480	0160-0127
A1C37	0180-2240	2	CAPACITOR-FXD: 2400UF+75-10% 25VDC AL	56289	39D2485025JL2
A1C38	0180-2240		CAPACITOR-FXD: 2400UF+75-10% 25VDC AL	56289	39D2485025JL2
A1C39	0160-4209	2	CAPACITOR-FXD .01UF +-20% 50WVDC POLYE	28480	0160-4209
A1C40	0160-4209		CAPACITOR-FXD .01UF +-20% 50WVDC POLYE	28480	0160-4209
A1C41	0180-0061	3	CAPACITOR-FXD: 100UF+75-10% 16VDC AL	56289	30D1075016DC2
A1C42	0180-0061		CAPACITOR-FXD: 100UF+75-10% 16VDC AL	56289	30D1075016DC2
A1C43	0180-0061		CAPACITOR-FXD: 100UF+75-10% 16VDC AL	56289	30D1075016DC2
A1C44	0160-2306	1	CAPACITOR-FXD 27PF +-5% 300WVDC MICA	28480	0160-2306
A1C45	0160-0174		CAPACITOR-FXD .47UF +-80-20% 25WVDC CER	28480	0160-0174
A1C47	0160-4210		CAPACITOR-FXD .022UF +-20% 50WVDC POLYE	28480	0160-4210
A1C48	0160-4210		CAPACITOR-FXD .022UF +-20% 50WVDC POLYE	28480	0160-4210
A1C49	0160-2259	1	CAPACITOR-FXD 12PF +-5% 500WVDC CER	28480	0160-2259
A1C50	0160-2959		CAPACITOR-FXD 1000PF +-80-20% 1000WVDC	28480	0160-2959
A1C51	0160-4210		CAPACITOR-FXD .022UF +-20% 50WVDC POLYE	28480	0160-4210
A1C52	0160-4210		CAPACITOR-FXD .022UF +-20% 50WVDC POLYE	28480	0160-4210
A1C53	0160-4213		CAPACITOR-FXD .1UF +-20% 50WVDC POLYE	28480	0160-4213
A1C54	0160-4213		CAPACITOR-FXD .1UF +-20% 50WVDC POLYE	28480	0160-4213
A1C57	0160-0134	1	CAPACITOR-FXD 220PF +-5% 300WVDC MICA	28480	0160-0134
A1C57	0160-2205	1	CAPACITOR-FXD 120PF +-5% 300WVDC MICA	28480	0160-2205
A1C60	0160-0174		CAPACITOR-FXD .47UF +-80-20% 25WVDC CER	28480	0160-0174
A1C61	0160-0174		CAPACITOR-FXD .47UF +-80-20% 25WVDC CER	28480	0160-0174
A1C62	0180-3470		CAPACITOR-FXD .01UF +-80-20% 50WVDC CER		
A1CR1	1901-0040	13	DIODE-SWITCHING 30V 50NA 2NS DO-35	28480	1901-0040
A1CR2	1901-0040		DIODE-SWITCHING 30V 50NA 2NS DO-35	28480	1901-0040
A1CR3	1901-0040		DIODE-SWITCHING 30V 50NA 2NS DO-35	28480	1901-0040
A1CR4	1901-0040		DIODE-SWITCHING 30V 50NA 2NS DO-35	28480	1901-0040
A1CR5	1901-0040		DIODE-SWITCHING 30V 50NA 2NS DO-35	28480	1901-0040
A1CR6	1902-0041	4	DIODE-ZNR 5.11V 5% DO-7 PD=.4W TC=-.009%	04713	SZ 10939-98
A1CR7	1901-0040		DIODE-SWITCHING 30V 50NA 2NS DO-35	28480	1901-0040
A1CR8	1902-0041		DIODE-ZNR 5.11V 5% DO-7 PD=.4W TC=-.009%	04713	SZ 10939-98
A1CR9	1902-0041		DIODE-ZNR 5.11V 5% DO-7 PD=.4W TC=-.009%	04713	SZ 10939-98
A1CR10	1902-3104	2	DIODE-ZNR 5.62V 5% DO-7 PD=.4W TC=+.016%	04713	SZ 10939-110
A1CR11	1902-3104		DIODE-ZNR 5.62V 5% DO-7 PD=.4W TC=+.016%	04713	SZ 10939-110
A1CR12	1901-0040		DIODE-SWITCHING 30V 50NA 2NS DO-35	28480	1901-0040
A1CR13	1901-0040		DIODE-SWITCHING 30V 50NA 2NS DO-35	28480	1901-0040
A1CR14	1901-0040		DIODE-SWITCHING 30V 50NA 2NS DO-35	28480	1901-0040
A1CR15	1901-0040		DIODE-SWITCHING 30V 50NA 2NS DO-35	28480	1901-0040

Table 6-5. (cont'd) Board A1 (Standard) Replaceable Parts List

Reference Designation	HP Part Number	Qty	Description	Mfr Code	Mfr Part Number
A1CR16	1901-0040	9	DIODE-SWITCHING 30V 50NA 2NS DO-35	28480	1901-0040
A1CR17	1901-0159		DIODE-PWR RECT 400V 750NA DO-41	04713	SR1358-4
A1CR18	1901-C159		DIODE-PWR RECT 400V 750NA DO-41	04713	SR1358-4
A1CR19	1901-0159		DIODE-PWR RECT 400V 750NA DO-41	04713	SR1358-4
A1CR20	1901-0159		DIODE-PWR RECT 400V 750NA DO-41	04713	SR1358-4
A1CR21	1901-0159	1	DIODE-PWR RECT 400V 750NA DO-41	04713	SR1358-4
A1CR22	1901-0159		DIODE-PWR RECT 400V 750NA DO-41	04713	SR1358-4
A1CR23	1901-C159		DIODE-PWR RECT 400V 750NA DO-41	04713	SR1358-4
A1CR24	1901-0159		DIODE-PWR RECT 400V 750NA DO-41	04713	SR1358-4
A1CR25	1902-1291		DIODE-ZNR 1N5338B 5.1V 5% PD=5W IR=1UA	04713	1N5338B
A1CR26	1901-0040	1	DIODE-SWITCHING 30V 50NA 2NS DO-35	28480	1901-0040
A1CR27	1901-0040		DIODE-SWITCHING 30V 50NA 2NS DO-35	28480	1901-0040
A1CR28	1901-C159		DIODE-PWR RECT 400V 750NA DO-41	04713	SR1358-4
A1CK31	1902-0041		DIODE-ZNR 5.11V 5% DO-7 PD=.4W TC=-.009%	04713	SZ 10939-98
A1L1	9140-0096	1	COIL FXD MOLDED RF CHOKE 1UH 10%		
A1L2	9140-0096	2	COIL FXD MOLDED RF CHOKE 1UH 20%		
A1L3	9100-1612	2	COIL-FXD MOLDED RF CHOKE .33UH 20%	24226	15/330
A1L4	9100-1657		COIL-FXD MOLDED RF CHOKE 1.5MH 5%	24226	22/154
A1L5	9100-1657		COIL-FXD MOLDED RF CHOKE 1.5MH 5%	24226	22/154
A1L6	9170-0029	3	CORE-SHIELDING BEAD	02114	56-590-65A2/4A
A1L7	9170-0029		CORE-SHIELDING BEAD	02114	56-590-65A2/4A
A1L8	9170-C629		CORE-SHIELDING BEAD	02114	56-590-65A2/4A
A1MP1	08011-01101	1	HT-SINK FOR Q33, Q34, Q37, Q38	28480	08011-01101
A1MP2	08011-01102	1	HT-SINK FOR Q27, Q28, Q29, Q30	28480	08011-01102
A1Q1	1854-0053	3	TRANSISTOR NPN 2N2218 SI TO-5 PD=800MW	04713	2N2218
A1Q2	1854-0053		TRANSISTOR NPN 2N2218 SI TO-5 PD=800MW	04713	2N2218
A1Q3	1854-0053		TRANSISTOR NPN 2N2218 SI TO-5 PD=800MW	04713	2N2218
A1Q4	1853-0089	7	TRANSISTOR PNP 2N4917 SI PD=200MW	07263	2N4917
A1Q5	1854-0215		TRANSISTOR NPN SI PD=350MW FT=300MHZ	04713	SPS 3611
A1Q6	1854-C215	7	TRANSISTOR NPN SI PD=350MW FT=300MHZ	04713	SPS 3611
A1Q7	1853-0089		TRANSISTOR PNP 2N4917 SI PD=200MW	07263	2N4917
A1Q8	1853-0089		TRANSISTOR PNP 2N4917 SI PD=200MW	07263	2N4917
A1Q9	1853-0036		TRANSISTOR PNP SI PD=310MW FT=250MHZ	28480	1853-0036
A1Q10	1854-0215		TRANSISTOR NPN SI PD=350MW FT=300MHZ	04713	SPS 3611
A1Q11	1853-0036		TRANSISTOR PNP SI PD=310MW FT=250MHZ	28480	1853-0036
A1Q12	1853-0089		TRANSISTOR PNP 2N4917 SI PD=200MW	07263	2N4917
A1Q13	1853-0036	4	TRANSISTOR PNP SI PD=310MW FT=250MHZ	28480	1853-0036
A1Q14	1853-0036		TRANSISTOR PNP SI PD=310MW FT=250MHZ	28480	1853-0036
A1Q15	1853-0089		TRANSISTOR PNP 2N4917 SI PD=200MW	07263	2N4917
A1Q16	1853-0089	4	TRANSISTOR PNP 2N4917 SI PD=200MW	07263	2N4917
A1Q17	1854-0630		TRANSISTOR NPN SI TO-52 PD=360MW	04713	SS2077
A1Q18	1854-0630		TRANSISTOR NPN SI TO-52 PD=360MW	04713	SS2077
A1Q19	1853-0089		TRANSISTOR PNP 2N4917 SI PD=200MW	07263	2N4917
A1Q20	1853-0036		TRANSISTOR PNP SI PD=310MW FT=250MHZ	28480	1853-0036
A1Q21	1854-0630		TRANSISTOR NPN SI TO-52 PD=360MW	04713	SS2077
A1Q22	1854-0630	2	TRANSISTOR NPN SI TO-52 PD=360MW	04713	SS2077
A1Q23	1853-0357		TRANSISTOR PNP SI TO-18 PD=360MW	28480	1853-0357
A1Q24	1853-0357	1	TRANSISTOR PNP SI TO-18 PD=360MW	28480	1853-0357
A1Q25	1853-0315		TRANSISTOR PNP SI TO-39 PD=1W FT=1GHZ	28480	1853-0315
A1Q25	1205-0061	2	HEAT-DISSIPATOR SGL TO-5/TO-39 PKG	28480	1205-0061
A1Q26	1854-0498	1	TRANSISTOR TO-39 PD=1W	28480	1854-0498
A1Q26	1205-0061		HEAT-DISSIPATOR SGL TO-5/TO-39 PKG	28480	1205-0061
A1Q27	1853-0012		TRANSISTOR PNP 2N2904A SI TO-5 PD=600MW	01295	2N2904A
A1Q28	1853-0012	2	TRANSISTOR PNP 2N2904A SI TO-5 PD=600MW	01295	2N2904A
A1Q29	1854-0213		TRANSISTOR NPN 2N2538 SI TO-5 PD=800MW	28480	1854-0213
A1Q30	1854-0213	1	TRANSISTOR NPN 2N2538 SI TO-5 PD=800MW	28480	1854-0213
A1Q31	1853-0036		TRANSISTOR PNP SI PD=310MW FT=250MHZ	28480	1853-0036
A1Q32	1854-0215		TRANSISTOR NPN SI PD=350MW FT=300MHZ	04713	SPS 3611
A1Q33	1854-0402		TRANSISTOR NPN SI PD=30W FT=3MHZ	28480	1854-0402
A1Q34	1853-0254	1	TRANSISTOR PNP SI PD=30W FT=3MHZ	28480	1853-0254
A1Q35	1854-0215	2	TRANSISTOR NPN SI PD=350MW FT=300MHZ	04713	SPS 3611
A1Q36	1853-0012		TRANSISTOR PNP 2N2904A SI TO-5 PD=600MW	01295	2N2904A
A1Q37	1853-0356		TRANSISTOR PNP SI PD=65W FT=3MHZ	28480	1853-0356
A1Q38	1853-0356		TRANSISTOR PNP SI PD=65W FT=3MHZ	28480	1853-0356
A1Q40	1853-0036	1	TRANSISTOR PNP SI PD=310MW FT=250MHZ	28480	1853-0036
A1R1	0758-0093	1	RESISTOR 56 5% .25W F TC=0+-100	24546	C5-1/4-TO-56R0-J
A1R2	0698-3242	4	RESISTOR 357 1% .125W F TC=0+-100	16299	C4-1/8-TO-357R-F
A1R3	0757-0284	2	RESISTOR 150 1% .125W F TC=0+-100	24546	C4-1/8-TO-151-F
A1R4	0757-0427	1	RESISTOR 1.5K 1% .125W F TC=0+-100	24546	C4-1/8-TO-1501-F
A1R5	0757-0398	1	RESISTOR 75 1% .125W F TC=0+-100	24546	C4-1/8-TO-75R0-F
A1R6	0698-3242	2	RESISTOR 357 1% .125W F TC=0+-100	16299	C4-1/8-TO-357R-F
A1R7	0757-0400		RESISTOR 90.9 1% .125W F TC=0+-100	24546	C4-1/8-TO-90R9-F
A1R8	0757-0442	2	RESISTOR 10K 1% .125W F TC=0+-100	24546	C4-1/8-TO-1002-F
A1R9	0757-0283	2	RESISTOR 2K 1% .125W F TC=0+-100	24546	C4-1/8-TO-201-F
A1R10	0757-0403	1	RESISTOR 121 1% .125W F TC=0+-100	24546	C4-1/8-TO-121R-F
A1R11	0698-3151	1	RESISTOR 2.7K 1% .125W F TC=0+-100	16299	C4-1/8-TO-2871-F
A1R12	0757-0428	7	RESISTOR 1.62K 1% .125W F TC=0+-100	24546	C4-1/8-TO-1621-F
A1R13	0757-0407	4	RESISTOR 200 1% .125W F TC=0+-100	24546	C4-1/8-TO-201-F
A1R14	0757-0405	3	RESISTOR 162 1% .125W F TC=0+-100	24546	C4-1/8-TO-162R-F
A1R15	0757-0394	2	RESISTOR 51.1 1% .125W F TC=0+-100	24546	C4-1/8-TO-51R1-F

Table 6-5. (cont'd) Board A1 (Standard) Replaceable Parts List

Reference Designation	HP Part Number	Qty	Description	Mfr Code	Mfr Part Number
A1R16	0758-0068	1	RESISTOR 910 5% .25W F TC=0+-100	24546	C5-1/4-T0-911-J
A1R17	0757-0411	3	RESISTOR 332 1% .125W F TC=0+-100	24546	C4-1/8-T0-332R-F
A1R18	0757-0416	3	RESISTOR 511 1% .125W F TC=0+-100	24546	C4-1/8-T0-511R-F
A1R19	0757-0437	2	RESISTOR 4.75K 1% .125W F TC=0+-100	24546	C4-1/8-T0-4751-F
A1R20	0757-0422	2	RESISTOR 909 1% .125W F TC=0+-100	24546	C4-1/8-T0-909R-F
A1R21	0757-0273	3	RESISTOR 3.01K 1% .125W F TC=0+-100	24546	C4-1/8-T0-3011-F
A1R22	0757-0273	3	RESISTOR 3.01K 1% .125W F TC=0+-100	24546	C4-1/8-T0-3011-F
A1R23	0757-0428	3	RESISTOR 1.62K 1% .125W F TC=0+-100	24546	C4-1/8-T0-1621-F
A1R24	0757-0397	3	RESISTOR 68.1 1% .125W F TC=0+-100	24546	C4-1/8-T0-68R1-F
A1R25	0757-0381	1	RESISTOR 15 1% .125W F TC=0+-100	19701	MF4C1/8-T0-15R0-F
A1R26	0757-0438	5	RESISTOR 5.11K 1% .125W F TC=0+-100	24546	C4-1/8-T0-5111-F
A1R27	0757-0437	5	RESISTOR 4.75K 1% .125W F TC=0+-100	24546	C4-1/8-T0-4751-F
A1R28	0757-0442	5	RESISTOR 10K 1% .125W F TC=0+-100	24546	C4-1/8-T0-1002-F
A1R29	0757-0401	7	RESISTOR 100 1% .125W F TC=0+-100	24546	C4-1/8-T0-101-F
A1R30	0698-3245	1	RESISTOR 20.5K 1% .125W F TC=0+-100	16299	C4-1/8-T0-2052-F
A1R31	0757-0408	2	RESISTOR 243 1% .125W F TC=0+-100	24546	C4-1/8-T0-243R-F
A1R32	0757-0283	2	RESISTOR 2K 1% .125W F TC=0+-100	24546	C4-1/8-T0-2001-F
A1R33	0757-0200	2	RESISTOR 5.62K 1% .125W F TC=0+-100	24546	C4-1/8-T0-5621-F
A1R34	0757-0431	4	RESISTOR 2.43K 1% .125W F TC=0+-100	24546	C4-1/8-T0-2431-F
A1R35	0757-0430	1	RESISTOR 2.21K 1% .125W F TC=0+-100	24546	C4-1/8-T0-2211-F
A1R36	0757-0401	1	RESISTOR 100 1% .125W F TC=0+-100	24546	C4-1/8-T0-101-F
A1R37	0757-0407	1	RESISTOR 200 1% .125W F TC=0+-100	24546	C4-1/8-T0-201-F
A1R38	0757-0410	2	RESISTOR 301 1% .125W F TC=0+-100	24546	C4-1/8-T0-301R-F
A1R39	0757-0431	1	RESISTOR 2.43K 1% .125W F TC=0+-100	24546	C4-1/8-T0-2431-F
A1R40	0757-0435	1	RESISTOR 3.92K 1% .125W F TC=0+-100	24546	C4-1/8-T0-3921-F
A1R41	0757-0414	1	RESISTOR 432 1% .125W F TC=0+-100	24546	C4-1/8-T0-432R-F
A1R42	0757-0420	1	RESISTOR 750 1% .125W F TC=0+-100	24546	C4-1/8-T0-751-F
A1R43	0757-0200	1	RESISTOR 5.62K 1% .125W F TC=0+-100	24546	C4-1/8-T0-5621-F
A1R44	0757-0410	1	RESISTOR 301 1% .125W F TC=0+-100	24546	C4-1/8-T0-301R-F
A1R45	0757-0799	1	RESISTOR 121 1% .5W F TC=0+-100	19701	MF7C-1/2-T0-121R-F
A1R46	0757-0284	1	RESISTOR 150 1% .125W F TC=0+-100	24546	C4-1/8-T0-151-F
A1R47	0698-3441	1	RESISTOR 215 1% .125W F TC=0+-100	16299	C4-1/8-T0-215R-F
A1R48	0757-0408	1	RESISTOR 243 1% .125W F TC=0+-100	24546	C4-1/8-T0-243R-F
A1R49	0757-0409	2	RESISTOR 274 1% .125W F TC=0+-100	24546	C4-1/8-T0-274R-F
A1R50	0757-0428	2	RESISTOR 1.62K 1% .125W F TC=0+-100	24546	C4-1/8-T0-1621-F
A1R51	0757-0386	2	RESISTOR 24.3 1% .125W F TC=0+-100	19701	MF4C1/8-T0-24R3-F
A1R52	0757-0422	2	RESISTOR 909 1% .125W F TC=0+-100	24546	C4-1/8-T0-909R-F
A1R53	0757-0273	2	RESISTOR 3.01K 1% .125W F TC=0+-100	24546	C4-1/8-T0-3011-F
A1R54	0757-0392	1	RESISTOR 43.2 1% .125W F TC=0+-100	24546	C4-1/8-T0-43R2-F
A1R55	0757-0401	1	RESISTOR 100 1% .125W F TC=0+-100	24546	C4-1/8-T0-101-F
A1R56	0757-0400	1	RESISTOR 90.9 1% .125W F TC=0+-100	24546	C4-1/8-T0-90R9-F
A1R57	0757-0401	1	RESISTOR 100 1% .125W F TC=0+-100	24546	C4-1/8-T0-101-F
A1R58	0758-0002	1	RESISTOR 560 5% .25W F TC=0+-100	24546	C5-1/4-T0-561-J
A1R59	0758-0054	1	RESISTOR 330 5% .25W F TC=0+-100	24546	C5-1/4-T0-331-J
A1R61	0757-0280	1	RESISTOR 1K 1% .125W F TC=0+-100	24546	C4-1/8-T0-1001-F
A1R62	0757-0409	1	RESISTOR 274 1% .125W F TC=0+-100	24546	C4-1/8-T0-274R-F
A1R63	0698-3262	2	RESISTOR 40.2 1% .125W F TC=0+-100	16299	C4-1/8-T0-4022-F
A1R63	0757-0397	2	RESISTOR 68.1 1% .125W F TC=0+-100	24546	C4-1/8-T0-68R1-F
A1R63	0757-0401	2	RESISTOR 100 1% .125W F TC=0+-100	24546	C4-1/8-T0-101-F
A1R64	0757-0397	1	RESISTOR 68.1 1% .125W F TC=0+-100	24546	C4-1/8-T0-68R1-F
A1R64	0698-3262	1	RESISTOR 40.2 1% .125W F TC=0+-100	16299	C4-1/8-T0-4022-F
A1R64	0757-0384	1	RESISTOR 20 1% .125W F TC=0+-100	24546	C4-1/8-T0-20R0-F
A1R65	0698-3242	1	RESISTOR 357 1% .125W F TC=0+-100	16299	C4-1/8-T0-357R-F
A1R66	0757-0401	1	RESISTOR 100 1% .125W F TC=0+-100	24546	C4-1/8-T0-101-F
A1R67	0757-0401	1	RESISTOR 100 1% .125W F TC=0+-100	24546	C4-1/8-T0-101-F
A1R68	0698-3242	1	RESISTOR 357 1% .125W F TC=0+-100	16299	C4-1/8-T0-357R-F
A1R69	0698-7521	4	RESISTOR 5.1 5% .25W F TC=0+-100	11502	TF07-1/4-T0-5R1-J
A1R70	0698-7521	4	RESISTOR 5.1 5% .25W F TC=0+-100	11502	TF07-1/4-T0-5R1-J
A1R71	0757-0431	4	RESISTOR 2.43K 1% .125W F TC=0+-100	24546	C4-1/8-T0-2431-F
A1R73	0698-7521	4	RESISTOR 5.1 5% .25W F TC=0+-100	11502	TF07-1/4-T0-5R1-J
A1R74	0698-7521	4	RESISTOR 5.1 5% .25W F TC=0+-100	11502	TF07-1/4-T0-5R1-J
A1R75	0757-0500	4	RESISTOR 30.1 1% .25W F TC=0+-100	24546	C5-1/4-T0-30R1-F
A1R76	0757-0503	1	RESISTOR 30.1 1% .25W F TC=0+-100	24546	C5-1/4-T0-30R1-F
A1R77	0757-0500	1	RESISTOR 30.1 1% .25W F TC=0+-100	24546	C5-1/4-T0-30R1-F
A1R78	0757-0500	1	RESISTOR 30.1 1% .25W F TC=0+-100	24546	C5-1/4-T0-30R1-F
A1R79	0757-0416	1	RESISTOR 511 1% .125W F TC=0+-100	24546	C4-1/8-T0-511R-F
A1R80	0757-0416	1	RESISTOR 511 1% .125W F TC=0+-100	24546	C4-1/8-T0-511R-F
A1R81	2100-0567	2	RESISTOR, VAR 2K 20% 0.5W LIN CC	28480	2100-0567
A1R82	0757-0438	2	RESISTOR 5.11K 1% .125W F TC=0+-100	24546	C4-1/8-T0-5111-F
A1R83	0757-0438	2	RESISTOR 5.11K 1% .125W F TC=0+-100	24546	C4-1/8-T0-5111-F
A1R84	2100-0567	2	RESISTOR, VAR 2K 20% 0.5W LIN CC	28480	2100-0567
A1R85	0698-5876	2	RESISTOR 10 5% .25W F TC=0+-100	24546	C5-1/4-T0-10R0-J
A1R86	0757-0407	1	RESISTOR 200 1% .125W F TC=0+-100	24546	C4-1/8-T0-201-F
A1R87	0757-0407	1	RESISTOR 200 1% .125W F TC=0+-100	24546	C4-1/8-T0-201-F
A1R88	0698-5876	1	RESISTOR 10 5% .25W F TC=0+-100	24546	C5-1/4-T0-10R0-J
A1R89	0757-0431	1	RESISTOR 2.43K 1% .125W F TC=0+-100	24546	C4-1/8-T0-2431-F
A1R92	0757-0346	1	RESISTOR 10 1% .125W F TC=0+-100	24546	C4-1/8-T0-10R0-F

Table 6-5. (cont'd) Board A1 (Standard) Replaceable Parts List

Reference Designation	HP Part Number	Qty	Description	Mfr Code	Mfr Part Number
A1R93	0757-0401		RESISTOR 100 1% .125W F TC=0+-100	24546	C4-1/8-T0-101-F
A1R94	0757-0386		RESISTOR 24.3 1% .125W F TC=0+-100	19701	MF4C1/8-T0-24R3-F
A1R95	0757-0394		RESISTOR 51.1 1% .125W F TC=0+-100	24546	C4-1/8-T0-51R1-F
A1R96	0766-0025	2	RESISTOR 101 2% 3W MO TC=0+-250	27167	FP3-3-250-101R-G
A1R97	0766-0025		RESISTOR 101 2% 3W MO TC=0+-250	27167	FP3-3-250-101R-G
A1R98	0761-0035	2	RESISTOR 150 5% 1W MO TC=0+-200	24546	FP32-1-T00-151-J
A1R99	0758-0080	2	RESISTOR 75 5% .25W F TC=0+-100	24546	C5-1/4-T0-7502-J
A1R100	0758-0080		RESISTOR 75 5% .25W F TC=0+-100	24546	C5-1/4-T0-7502-J
A1R101	0761-0035		RESISTOR 150 5% 1W MO TC=0+-200	24546	FP32-1-T00-151-J
A1R102	0758-0082	2	RESISTOR 130 5% .25W F TC=0+-100	24546	C5-1/4-T0-131-J
A1R103	0758-0082		RESISTOR 130 5% .25W F TC=0+-100	24546	C5-1/4-T0-131-J
A1R104	0757-1060	1	RESISTOR 196 1% .5W F TC=0+-100	19701	MF7C1/2-T0-196R-F
A1R105	0698-4825	1	RESISTOR 64.9 1% .5W F TC=0+-100	24546	NA6
A1R107	0757-0438		RESISTOR 5.11K 1% .125W F TC=0+-100	24546	C4-1/8-T0-5111-F
A1R108	0757-0438		RESISTOR 5.11K 1% .125W F TC=0+-100	24546	C4-1/8-T0-5111-F
A1R109	0698-3620	2	RESISTOR 100 5% 2W MO TC=0+-200	24546	FP42-2-T00-100R-J
A1R110	0698-3620		RESISTOR 100 5% 2W MO TC=0+-200	24546	FP42-2-T00-100R-J
A1R111	2100-3104	1	RESISTOR, VAR 50 OHM 10% 5W, CC	01121	0B0
A1R112	0698-5880	2	RESISTOR 15 5% .25W F TC=0+-100	24546	C5-1/4-T0-15R0-J
A1R113	0698-3616	1	RESISTOR 62 5% 2W MO TC=0+-200	16299	FP42-2-T00-62R0-J
A1R114	0757-0421	3	RESISTOR 825 1% .125W F TC=0+-100	24546	C4-1/8-T0-825R-F
A1R115	0757-0421		RESISTOR 825 1% .125W F TC=0+-100	24546	C4-1/8-T0-825R-F
A1R116	0757-0411		RESISTOR 332 1% .125W F TC=0+-100	24546	C4-1/8-T0-332R-F
A1R117	0757-0411		RESISTOR 332 1% .125W F TC=0+-100	24546	C4-1/8-T0-332R-F
A1R118	0757-0421		RESISTOR 825 1% .125W F TC=0+-100	24546	C4-1/8-T0-825R-F
A1R119	0698-5880		RESISTOR 15 5% .25W F TC=0+-100	24546	C5-1/4-T0-15R0-J
A1R120	0812-0021	2	RESISTOR .47 5% 3W PW TC=0+-90	91637	CW2B1-3-T2-47/100-J
A1R123	0812-0021		RESISTOR .47 5% 3W PW TC=0+-90	91637	CW2B1-3-T2-47/100-J
A1R124	0757-0428		RESISTOR 1.62K 1% .125W F TC=0+-100	24546	C4-1/8-T0-1621-F
A1R125	2100-3211	2	R:VAR CERMET 1000 OHM 20%	28480	2100-3211
A1R126	0757-0428		RESISTOR 1.62K 1% .125W F TC=0+-100	24546	C4-1/8-T0-1621-F
A1R127	0757-0428		RESISTOR 1.62K 1% .125W F TC=0+-100	24546	C4-1/8-T0-1621-F
A1R128	2100-3211		R:VAR CERMET 1000 OHM 20%	28480	2100-3211
A1R129	0757-0428		RESISTOR 1.62K 1% .125W F TC=0+-100	24546	C4-1/8-T0-1621-F
A1R130	0757-0405		RESISTOR 162 1% .125W F TC=0+-100	24546	C4-1/8-T0-162R-F
A1R131	2100-3212	2	R VAR 200 OHM	28480	2100-3212
A1R132	0698-4431	1	RESISTOR 2.05K 1% .125W F TC=0+-100	16299	C4-1/8-T0-2051-F
A1R133	2100-3212		R VAR 200 OHM	28480	2100-3212
A1R134	0757-0405		RESISTOR 162 1% .125W F TC=0+-100	24546	C4-1/8-T0-162R-F
A1R135	0698-5137	4	RESISTOR 47 5% .25W F TC=0+-100	24546	C5-1/4-T0-47R0-D
A1R136	0698-5137		RESISTOR 47 5% .25W F TC=0+-100	24546	C5-1/4-T0-47R0-D
A1R137	0698-5137		RESISTOR 47 5% .25W F TC=0+-100	24546	C5-1/4-T0-47R0-D
A1R138	0698-5137		RESISTOR 47 5% .25W F TC=0+-100	24546	C5-1/4-T0-47R0-D
A1R139	0757-0384		RESISTOR 20 1% .125W F TC=0+-100		
A1S1	3101-0597	1	SWITCH-PB 95TA .394 IN-CTRS .25A 120VAC	28480	3101-0597
A1S2	3101-0596	1	SWITCH-PB 35TA INTLH .394 IN-CTRS .25A	28480	3101-0596
A1S3	3101-0595	1	SWITCH-PB 55TA .394 IN-CTRS .25A 120VAC	28480	3101-0595
A1S4	3101-0593	1	SWITCH-PB 55TA .394 IN-CTRS .25A 120VAC	28480	3101-0593
A1S5	3101-0598	1	SWITCH-PB DPDT MOM	28480	3101-0598
A1S6	3101-0555	1	SWITCH-PB DPDT ALTN 4A 250VAC	28480	3101-0555
A1S7	3101-0629	2	SWITCH-SL DPDT-NS MINTR 2A 250VAC PC	28480	3101-0629
A1S8	3101-0629		SWITCH-SL DPDT-NS MINTR 2A 250VAC PC	28480	3101-0629
A1U1	1820-0092	1	IC AMPL	28480	1826-0092
A1U2	1820-0111	1	IC MC1458 50 N GATE		
A1U3	1820-0065	1	IC SN74 70 N FLIP-FLDP	01295	SN7470N
A1U4	1820-0330	1	IC SN74H 53 N GATE	01295	SN74H53N
A1U5	1820-0196	2	IC RGLTR	07263	723HC
A1U6	1820-0196		IC RGLTR	07263	723HC

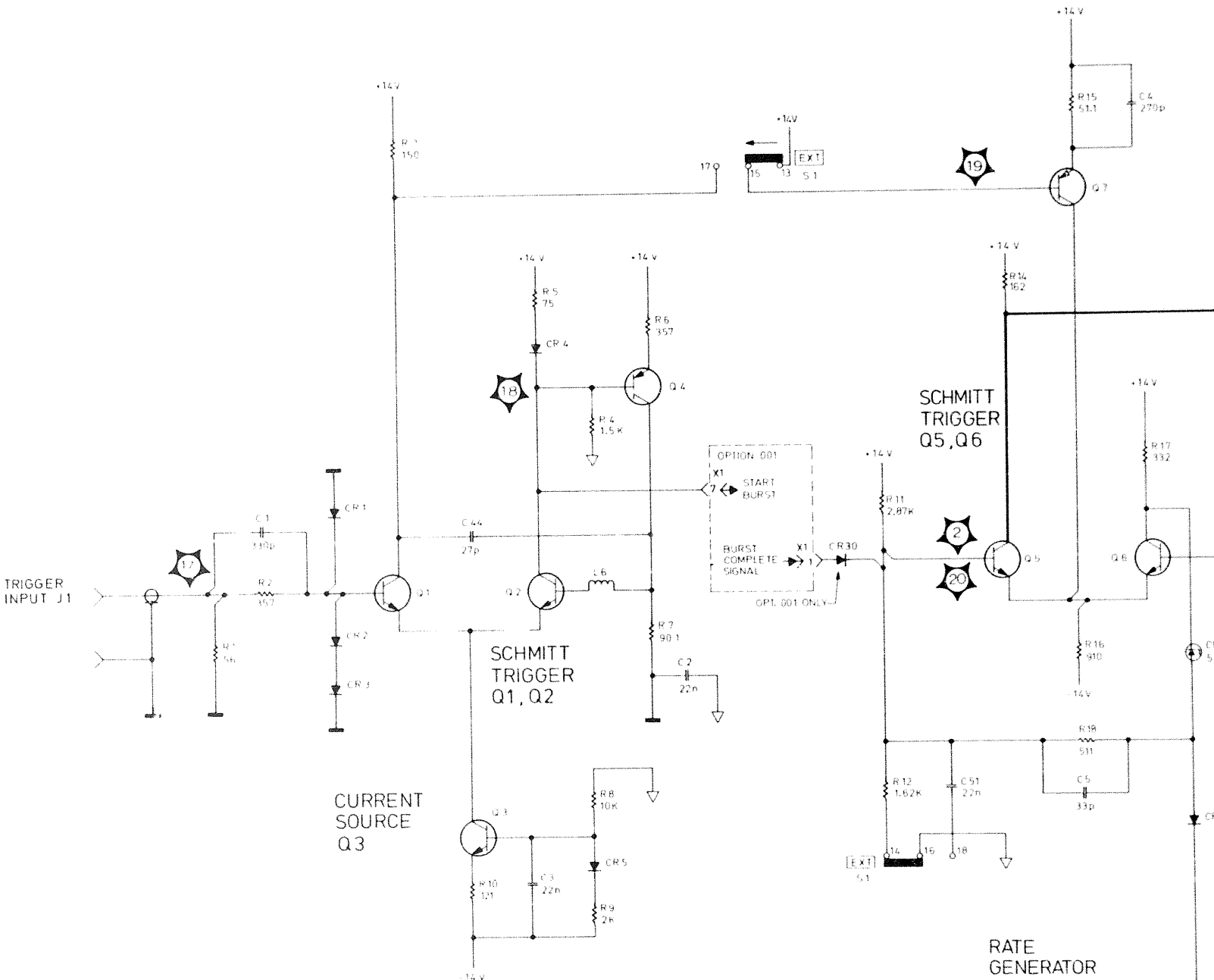

NOTES:

1. ALL VOLTAGES ARE REFERENCED TO FLOATING GROUND.
2. ALL SWITCHES ARE SHOWN IN THE "OUT" POSITION.

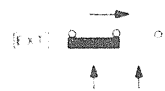

POINT IN TO SELECT MODE OR RANGE

3. COMPONENT A1C7 IS FACTORY SELECTABLE AND MAY VARY FROM 120pF TO 140pF (INFLUENCES MAXIMUM REPETITION RATE)

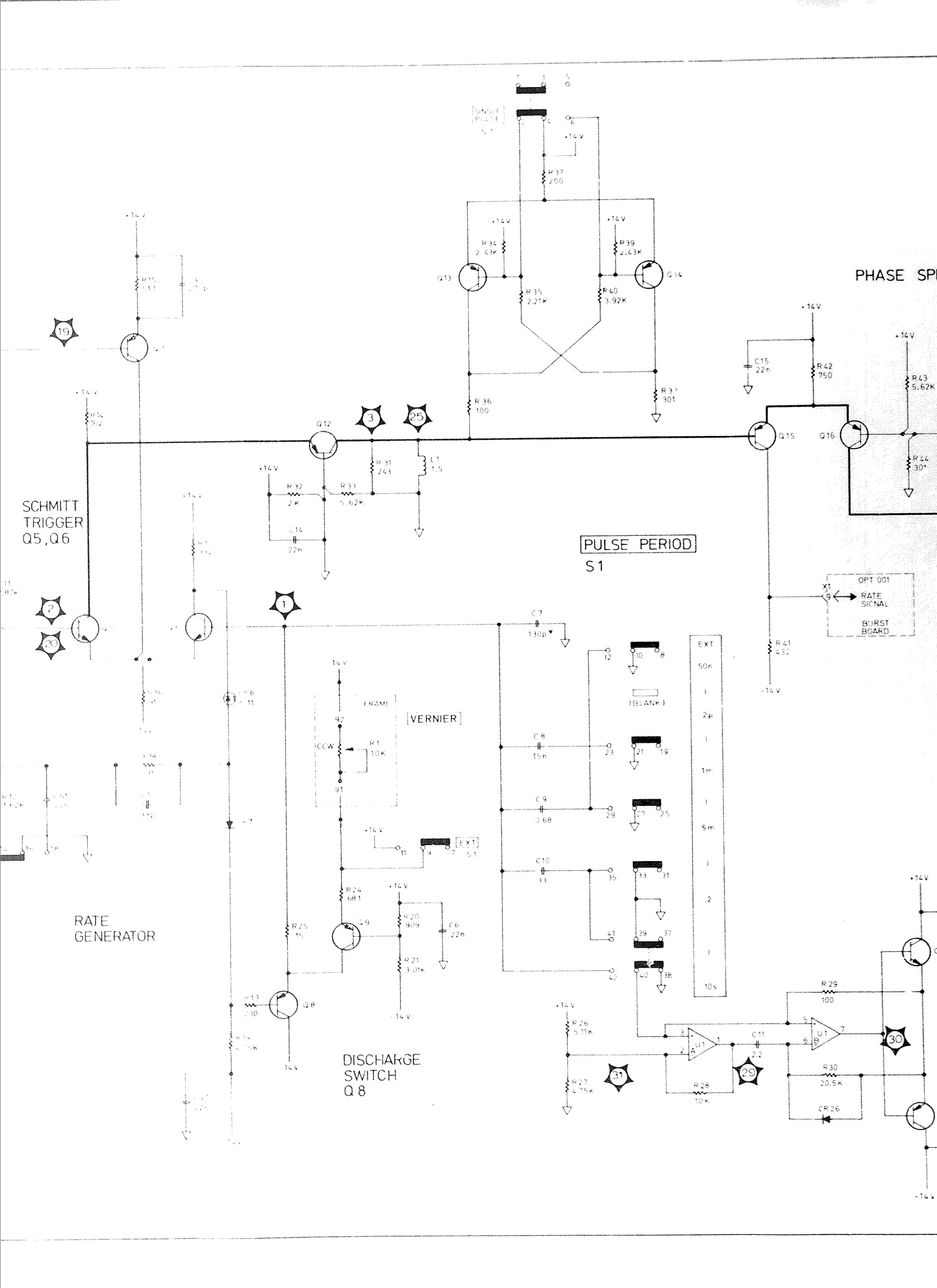

SCHMITT TRIGGER
Q5, Q6

RATE GENERATOR

DISCHARGE SWITCH
Q 8

PULSE PERIOD
S1

PHASE SPLITTER

OPT 001
RATE SIGNAL
BURST BOARD

EXT
50n
1
2μ
1
1m
1
5m
1
.2
1
10s

VERNIER

FRAME
CCW
R1 10K

SMALL
PULSE
S1

-14V

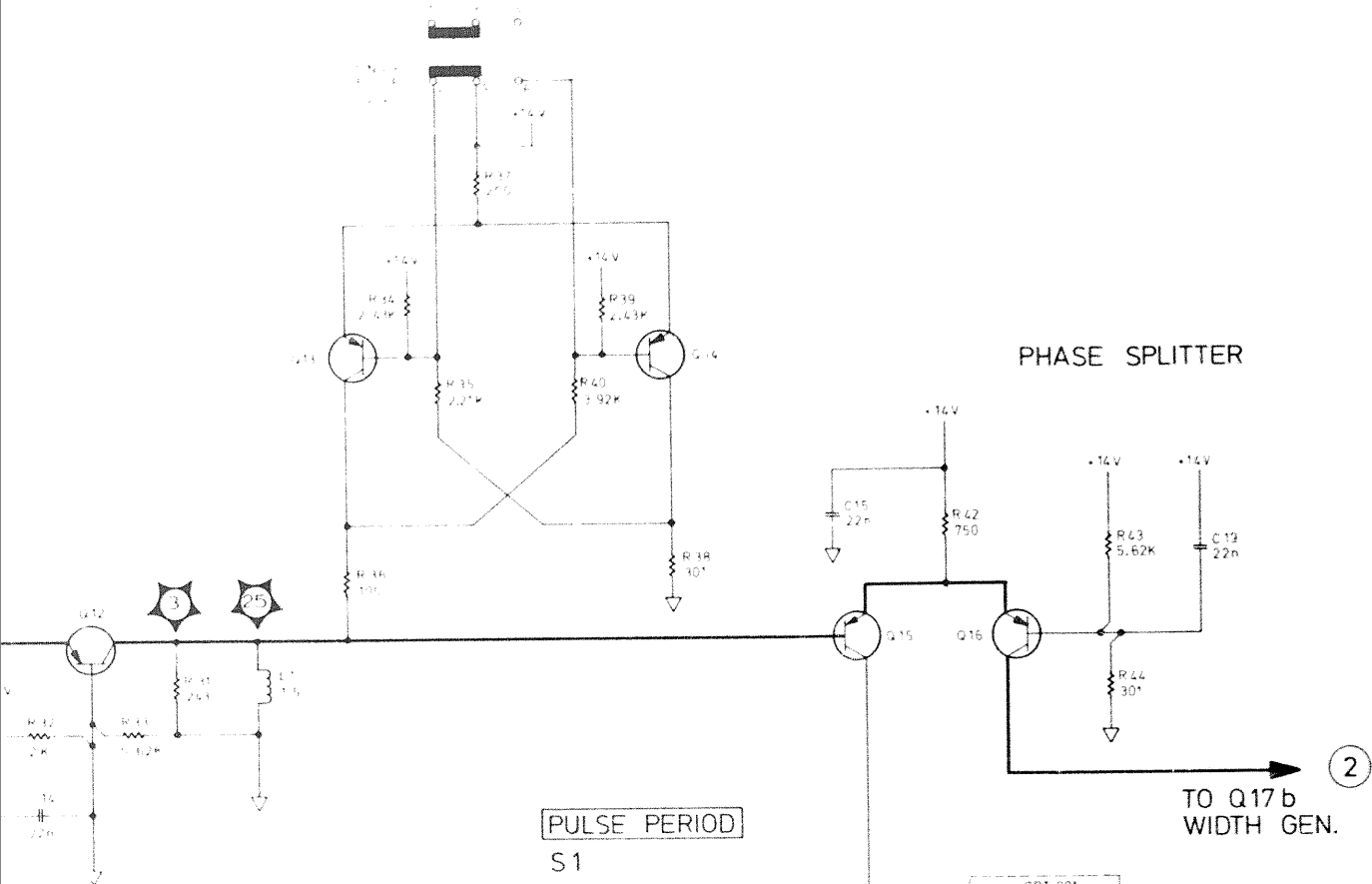

PULSE PERIOD
S1

PHASE SPLITTER

TO Q17 b
WIDTH GEN.

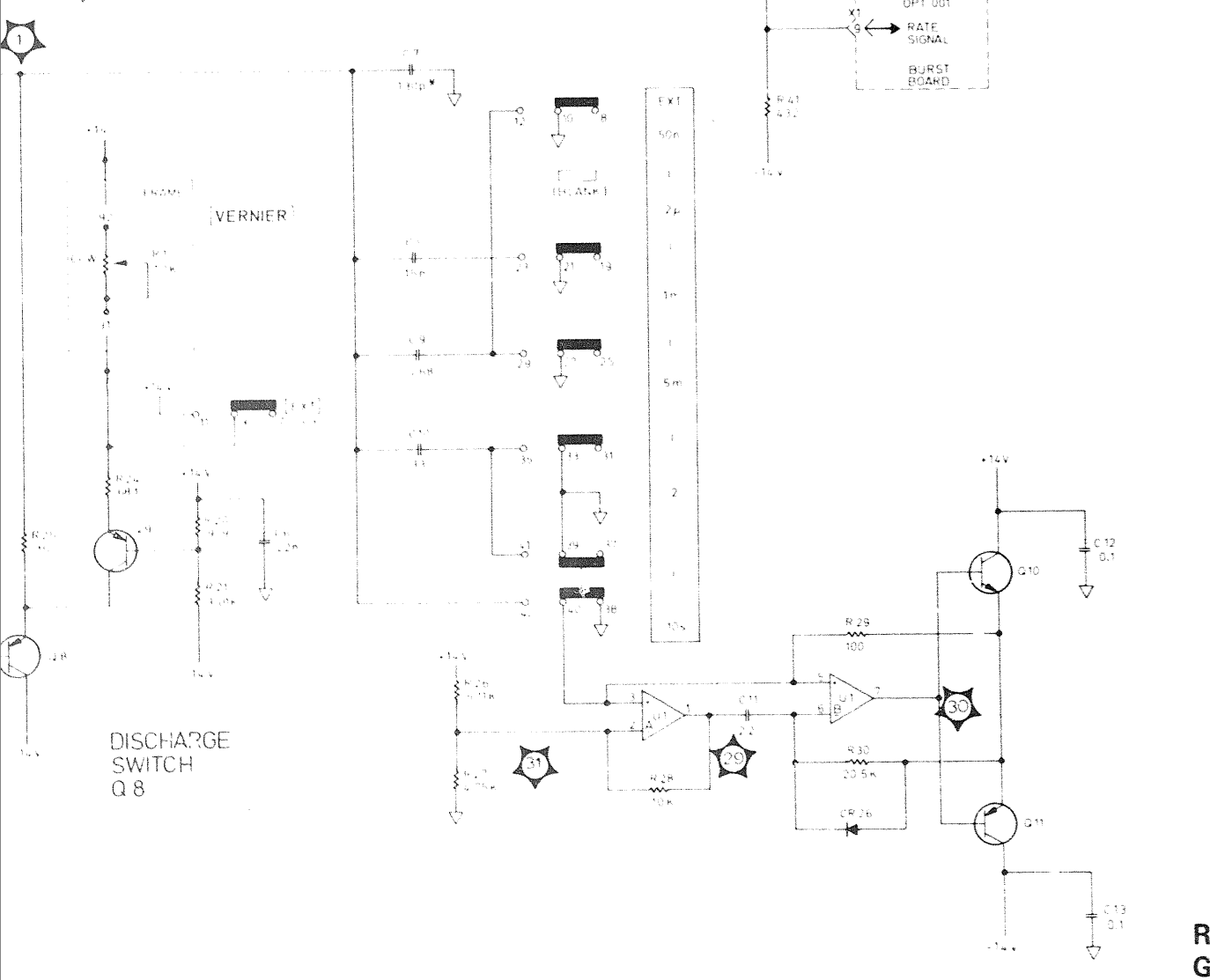

VERNIER

DISCHARGE
SWITCH
Q 8

RATE
GENERATOR

1

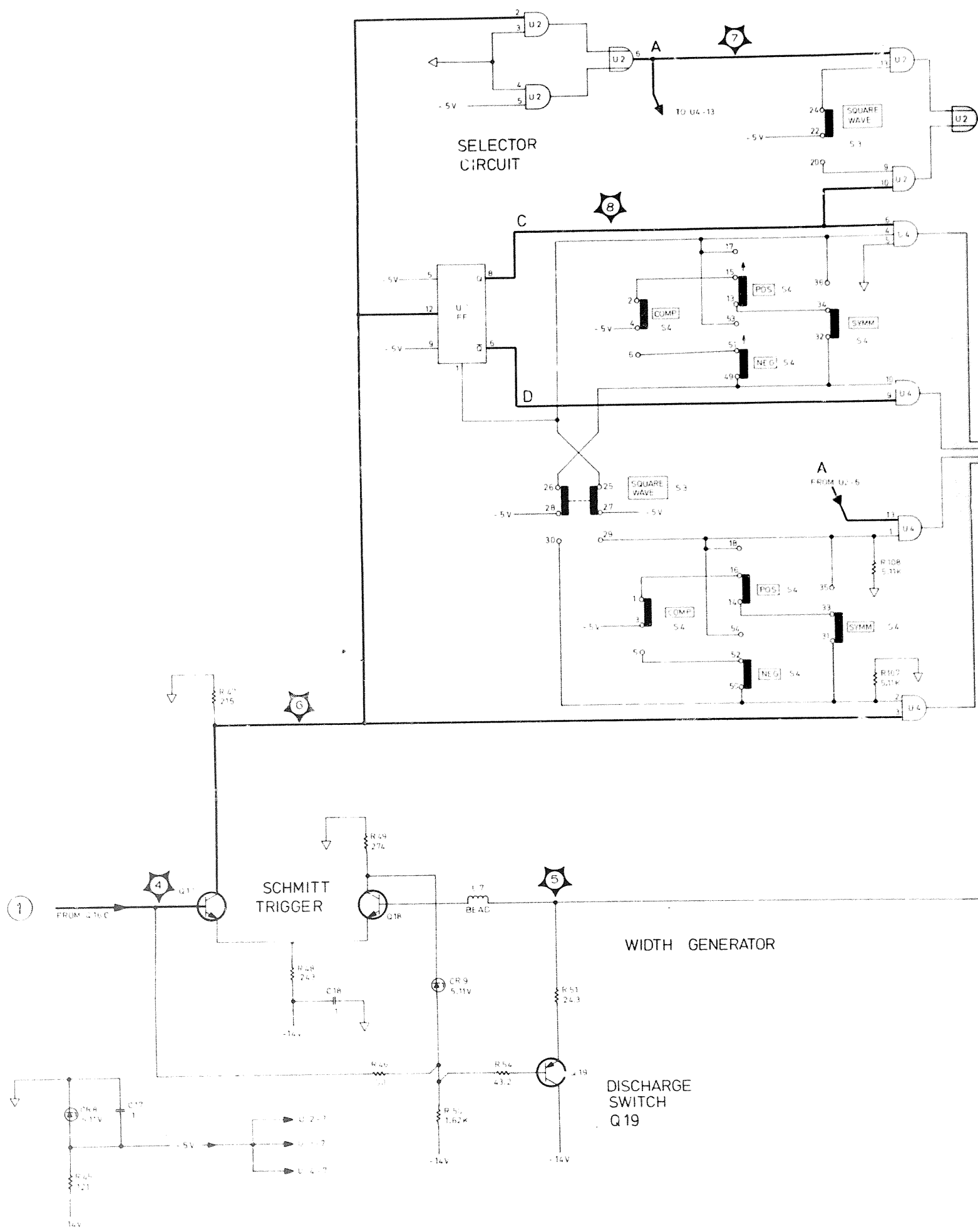

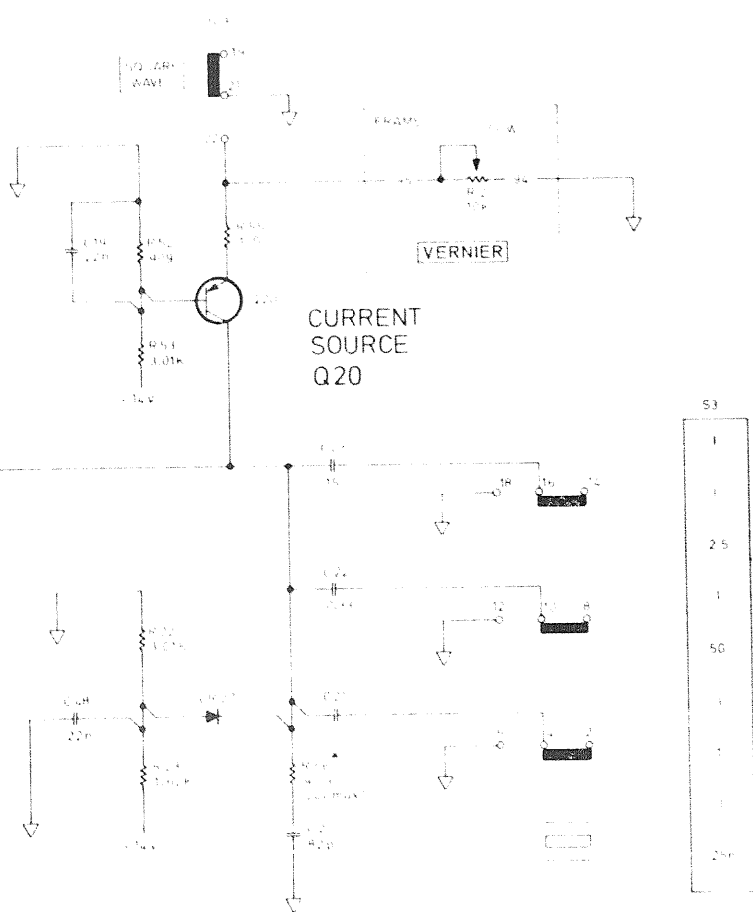
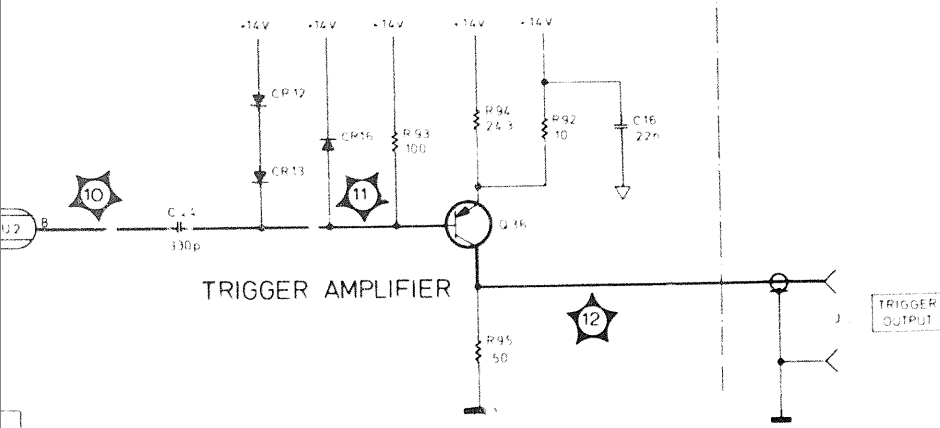

NOTES:

1. UNLESS OTHERWISE STATED ALL VOLTAGES ARE REFERENCED TO FLOATING GROUND.
2. ALL SWITCHES ARE SHOWN IN THE "OUT" POSITION

3. COMPONENT AIR56 IS FACTORY SELECTABLE AND MAY VARY FROM 90.9 Ω TO 200 Ω (INFLUENCES MINIMUM WIDTH)

2

WIDTH GENERATOR AND SELECTOR CIRCUIT

NOTES

- 1 ALL VOLTAGES ARE REFERENCED TO FLOATING GROUND.
2. ALL SWITCHES ARE SHOWN IN THE "OUT" POSITION

'PUSH IN' TO SELECT MODE OR RANGE

COMPONENT	RANGE OF VALUES	RELATED PULSE PARAMETER
A1 C49	0 - 24 pF	TRANSITION TIME AND OVERSHOOT
A1 C57	47 pF - 220 pF	OVERSHOOT
A1 R61	821 Ω - 1K Ω	MINIMUM WIDTH
A1 R63	33 Ω - 75 Ω	TRANSITION TIME AND OVERSHOOT
A1 R64		

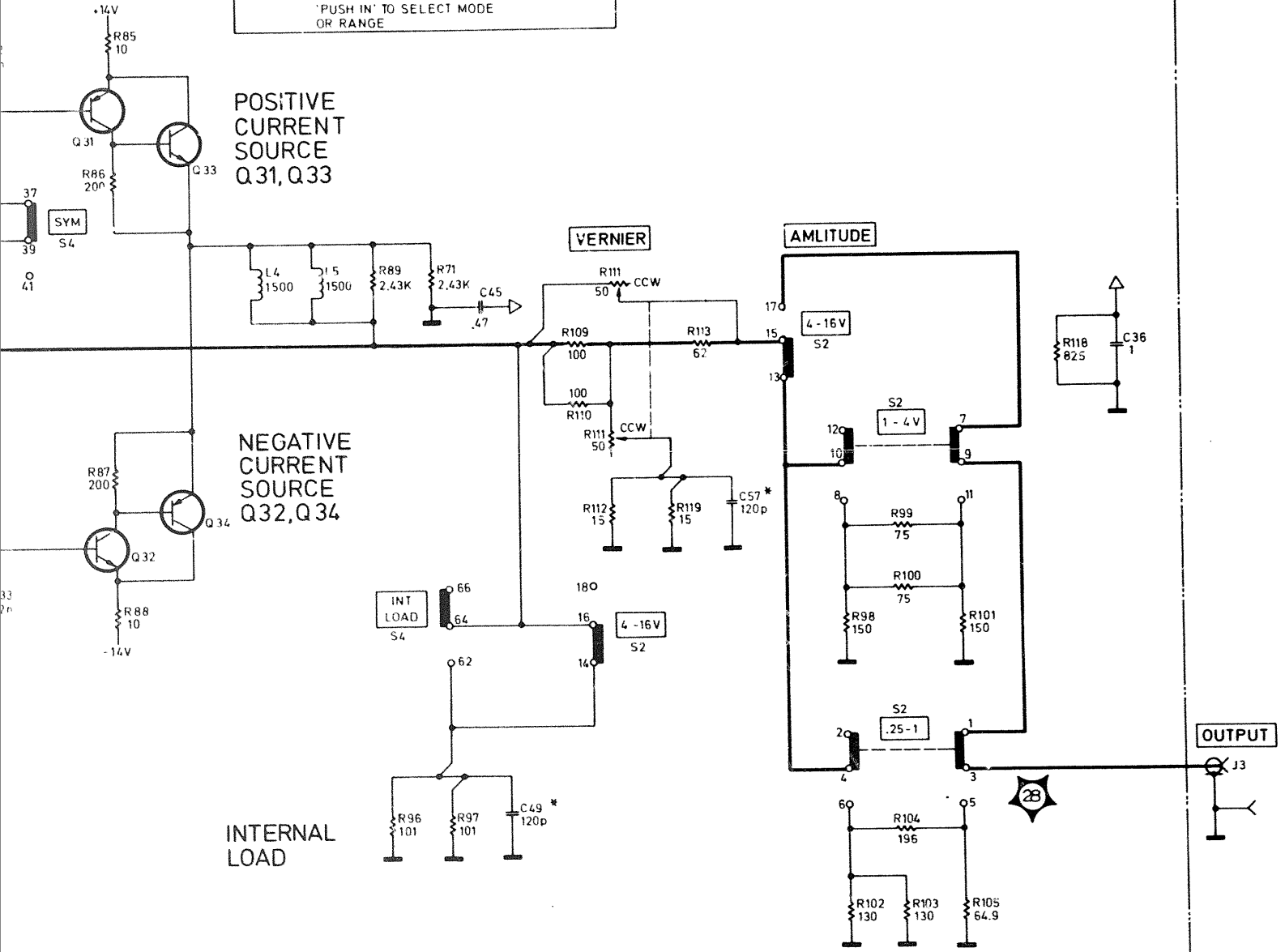

P/O A1

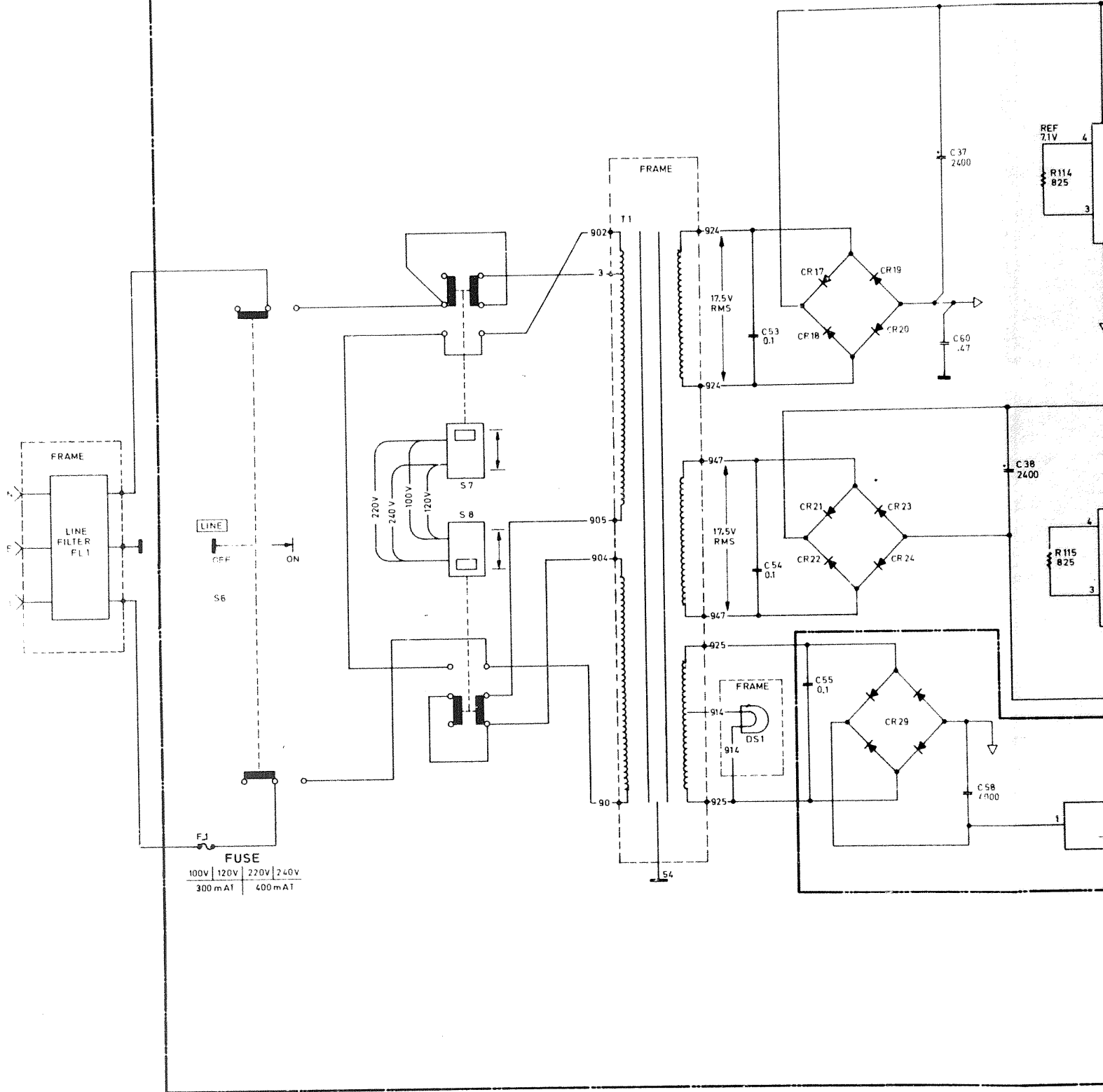

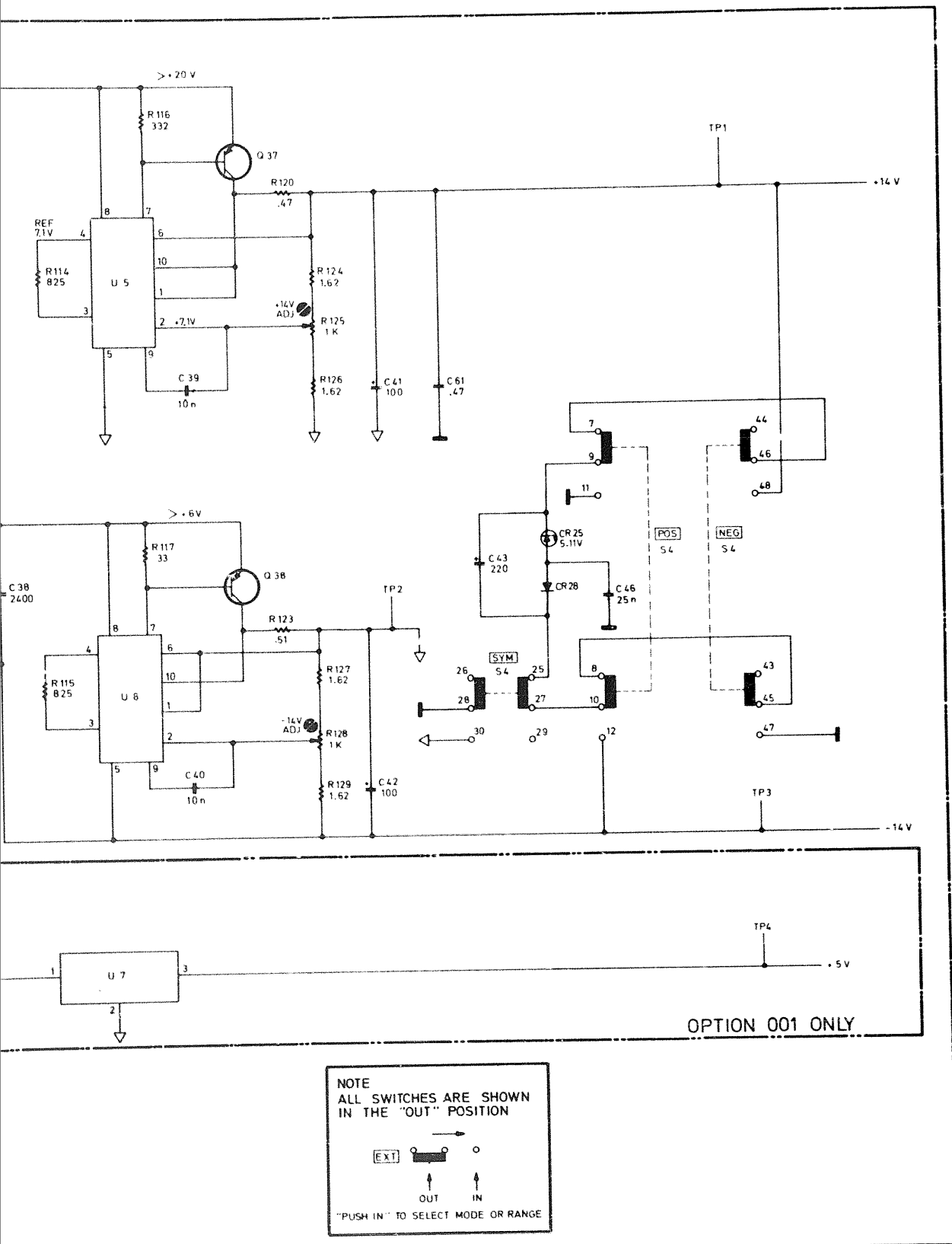

NOTE
 ALL SWITCHES ARE SHOWN
 IN THE "OUT" POSITION

"PUSH IN" TO SELECT MODE OR RANGE

A2 (Option 001)
08011-66502

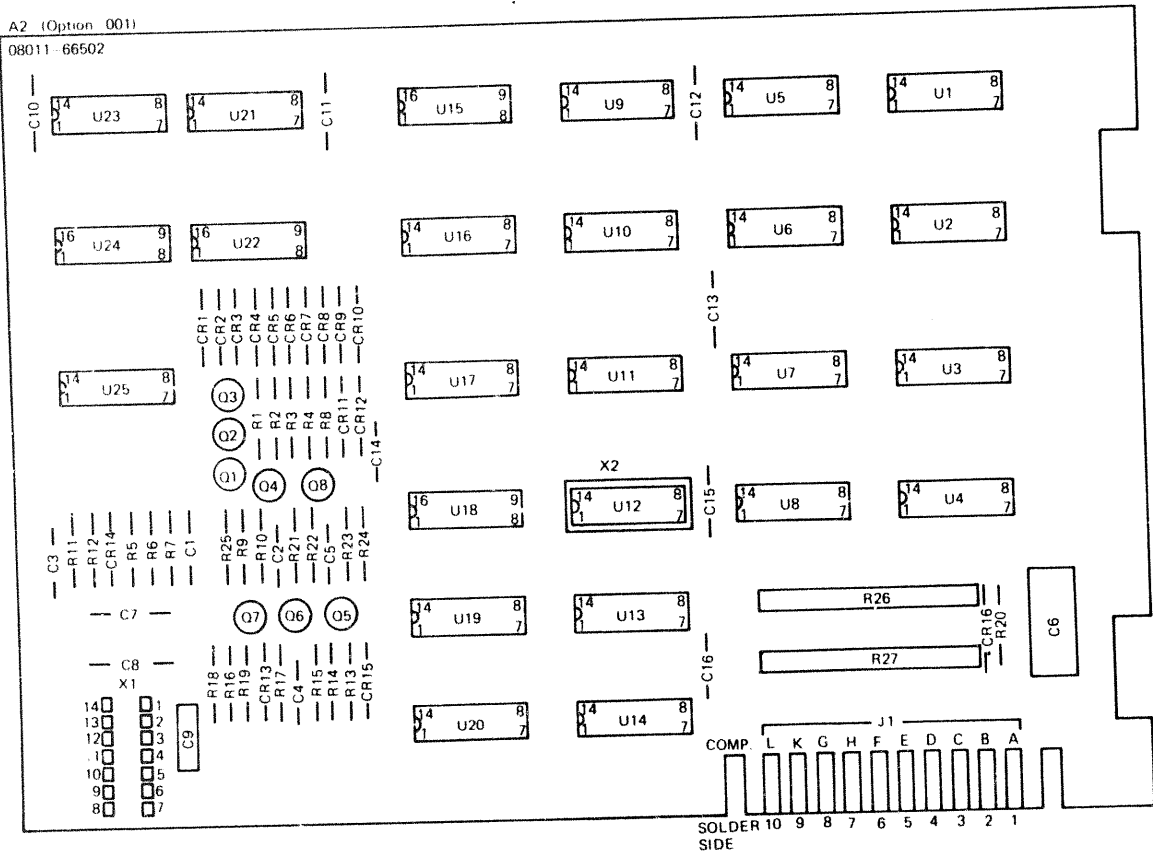

Table 6-6. Board A2 (Option 001) Replaceable Parts List

Reference Designation	HP Part Number	Qty	Description	Mfr Code	Mfr Part Number
A2	08011-66502		BOARD ASSEMBLY, BURST (OPTION 001)	28480	08011-66502
A2C1	0160-4210	3	CAPACITOR-FXD .022UF +-20% 50WVDC POLYE	28480	0160-4210
A2C2	0140-0192	1	CAPACITOR-FXD 68PF +-5% 300WVDC MICA	72136	DM15E690J0300WVICR
A2C3	0160-2216	1	CAPACITOR-FXD 820PF +-5% 300WVDC MICA	28490	0160-2216
A2C4	0160-4210		CAPACITOR-FXD .022UF +-20% 50WVDC POLYE	28480	0160-4210
A2C5	0160-4210		CAPACITOR-FXD .022UF +-20% 50WVDC POLYE	28480	0160-4210
A2C6	0180-0229	2	CAPACITOR-FXD: 33UF+-10% 10VDC TA-SOLID	56289	1500336X901082
A2C7	0160-4213	2	CAPACITOR-FXD .01UF +-20% 50WVDC POLYE	28480	0160-4213
A2C8	0160-4213		CAPACITOR-FXD .01UF +-20% 50WVDC POLYE	28480	0160-4213
A2C9	0180-0229		CAPACITOR-FXD: 33UF+-10% 10VDC TA-SOLID	56289	1500336X901082
A2C10	0160-2930	7	CAPACITOR-FXD .01UF +-80-20% 100WVDC CER	28480	0160-2930
A2C11	0160-2930		CAPACITOR-FXD .01UF +-80-20% 100WVDC CER	28480	0160-2930
A2C12	0160-2930		CAPACITOR-FXD .01UF +-80-20% 100WVDC CER	28480	0160-2930
A2C13	0160-2930		CAPACITOR-FXD .01UF +-80-20% 100WVDC CER	28480	0160-2930
A2C14	0160-2930		CAPACITOR-FXD .01UF +-80-20% 100WVDC CER	28480	0160-2930
A2C15	0160-2930		CAPACITOR-FXD .01UF +-80-20% 100WVDC CER	28480	0160-2930
A2C16	0160-2930		CAPACITOR-FXD .01UF +-80-20% 100WVDC CER	28480	0160-2930
A2C17	1901-0179	11	DIODE-SWITCHING 15V 50NA 750PS 00-7	28480	1901-0179
A2C18	1901-0179		DIODE-SWITCHING 15V 50NA 750PS 00-7	28480	1901-0179
A2C19	1901-0179		DIODE-SWITCHING 15V 50NA 750PS 00-7	28480	1901-0179
A2C20	1901-0179		DIODE-SWITCHING 15V 50NA 750PS 00-7	28480	1901-0179
A2C21	1901-0179		DIODE-SWITCHING 15V 50NA 750PS 00-7	28480	1901-0179
A2C22	1901-0179		DIODE-SWITCHING 15V 50NA 750PS 00-7	28480	1901-0179
A2C23	1901-0179		DIODE-SWITCHING 15V 50NA 750PS 00-7	28480	1901-0179
A2C24	1901-0179		DIODE-SWITCHING 15V 50NA 750PS 00-7	28480	1901-0179
A2C25	1901-0179		DIODE-SWITCHING 15V 50NA 750PS 00-7	28480	1901-0179
A2C26	1901-0179		DIODE-SWITCHING 15V 50NA 750PS 00-7	28480	1901-0179
A2C27	1901-0179		DIODE-SWITCHING 15V 50NA 750PS 00-7	28480	1901-0179
A2C28	1901-0179		DIODE-SWITCHING 15V 50NA 750PS 00-7	28480	1901-0179
A2C29	1901-0179		DIODE-SWITCHING 15V 50NA 750PS 00-7	28480	1901-0179
A2C30	1901-0535	1	DIODE-SWITCHING 15V 50NA 750PS 00-7	28480	1901-0535
A2C31	1901-0179		DIODE-SWITCHING 15V 50NA 750PS 00-7	28480	1901-0179
A2C32	1901-0179		DIODE-SWITCHING 15V 50NA 750PS 00-7	28480	1901-0179
A2C33	1901-0040	4	DIODE-SWITCHING 30V 50NA 2NS 00-35	28480	1901-0040
A2C34	1901-0040		DIODE-SWITCHING 30V 50NA 2NS 00-35	28480	1901-0040
A2C35	1901-0040		DIODE-SWITCHING 30V 50NA 2NS 00-35	28480	1901-0040
A2C36	1901-0040		DIODE-SWITCHING 30V 50NA 2NS 00-35	28480	1901-0040
A2C37	1901-0040		DIODE-SWITCHING 30V 50NA 2NS 00-35	28480	1901-0040
A2C38	1854-0215	2	TRANSISTOR NPN SI PD=350MW FT=300MHZ	04713	SPS 3611
A2C39	1853-0089	5	TRANSISTOR PNP 2N4917 SI PD=200MW	07263	2N4917
A2C40	1853-0089		TRANSISTOR PNP 2N4917 SI PD=200MW	07263	2N4917
A2C41	1853-0089		TRANSISTOR PNP 2N4917 SI PD=200MW	07263	2N4917
A2C42	1853-0089		TRANSISTOR PNP 2N4917 SI PD=200MW	07263	2N4917
A2C43	1853-0089		TRANSISTOR PNP 2N4917 SI PD=200MW	07263	2N4917
A2C44	1853-0089		TRANSISTOR PNP 2N4917 SI PD=200MW	07263	2N4917
A2C45	1853-0089		TRANSISTOR PNP 2N4917 SI PD=200MW	07263	2N4917
A2C46	1853-0089		TRANSISTOR PNP 2N4917 SI PD=200MW	07263	2N4917
A2C47	1854-0215		TRANSISTOR NPN SI PD=350MW FT=300MHZ	04713	SPS 3611
A2C48	1854-0005	1	TRANSISTOR NPN 2N708 SI TJ=18 PD=360MW	28480	1854-0005
A2C49	0757-0411	2	RESISTOR 332 1% .125W F TC=0+-100	24546	C4-1/8-TJ-332R-F
A2C50	0698-3242	1	RESISTOR 357 1% .125W F TC=0+-100	16299	C4-1/8-TJ-357R-F
A2C51	0757-0388	2	RESISTOR 30.1 1% .125W F TC=0+-100	24546	C4-1/8-TJ-30R1-F
A2C52	0757-0388		RESISTOR 30.1 1% .125W F TC=0+-100	24546	C4-1/8-TJ-30R1-F
A2C53	0757-0413	1	RESISTOR 392 1% .125W F TC=0+-100	24546	C4-1/8-TJ-392R-F
A2C54	0757-0410	2	RESISTOR 562 1% .125W F TC=0+-100	24546	C4-1/8-TJ-562R-F
A2C55	0757-0417	2	RESISTOR 301 1% .125W F TC=0+-100	24546	C4-1/8-TJ-301R-F
A2C56	0757-0410		RESISTOR 301 1% .125W F TC=0+-100	24546	C4-1/8-TJ-301R-F
A2C57	0757-0410		RESISTOR 301 1% .125W F TC=0+-100	24546	C4-1/8-TJ-301R-F
A2C58	0757-0417		RESISTOR 562 1% .125W F TC=0+-100	24546	C4-1/8-TJ-562R-F
A2C59	0757-0417		RESISTOR 562 1% .125W F TC=0+-100	24546	C4-1/8-TJ-562R-F
A2C60	0757-0411		RESISTOR 332 1% .125W F TC=0+-100	24546	C4-1/8-TJ-332R-F
A2C61	0757-0437	1	RESISTOR 4.75K 1% .125W F TC=0+-100	24546	C4-1/8-TJ-4751-F
A2C62	0757-0416	1	RESISTOR 511 1% .125W F TC=0+-100	24546	C4-1/8-TJ-511R-F
A2C63	0757-0407	1	RESISTOR 200 1% .125W F TC=0+-100	24546	C4-1/8-TJ-201-F
A2C64	0757-0431	1	RESISTOR 100 1% .125W F TC=0+-100	24546	C4-1/8-TJ-101-F
A2C65	0757-0428	1	RESISTOR 1.62K 1% .125W F TC=0+-100	24546	C4-1/8-TJ-1621-F
A2C66	0757-0444	1	RESISTOR 12.1K 1% .125W F TC=0+-100	24546	C4-1/8-TJ-1212-F
A2C67	0698-3496	1	RESISTOR 3.57K 1% .125W F TC=0+-100	16299	C4-1/8-TJ-357R-F
A2C68	0757-0433	2	RESISTOR 3.32K 1% .125W F TC=0+-100	24546	C4-1/8-TJ-3321-F
A2C69	0757-0443	1	RESISTOR 11K 1% .125W F TC=0+-100	24546	C4-1/8-TJ-1102-F
A2C70	0757-0442	1	RESISTOR 10K 1% .125W F TC=0+-100	24546	C4-1/8-TJ-1002-F
A2C71	0757-0433		RESISTOR 3.32K 1% .125W F TC=0+-100	24546	C4-1/8-TJ-3321-F
A2C72	0698-3492	1	RESISTOR 2.67K 1% .125W F TC=0+-100	16299	C4-1/8-TJ-2671-F
A2C73	0757-0421	1	RESISTOR 825 1% .125W F TC=0+-100	24546	C4-1/8-TJ-825R-F
A2C74	0757-0283	1	RESISTOR 2K 1% .125W F TC=0+-100	24546	C4-1/8-TJ-2001-F
A2C75	0757-0435	1	RESISTOR 3.92K 1% .125W F TC=0+-100	24546	C4-1/8-TJ-3921-F
A2C76	1810-0055	2	NETWORK-FES 9-PIN-SIP .15-PIN-SPCG	28480	1810-0055
A2C77	1810-0055		NETWORK-FES 9-PIN-SIP .15-PIN-SPCG	28480	1810-0055

Table 6-6. (cont'd) Board A2 (Option 001) Replaceable Parts List

Reference Designation	HP Part Number	Qty	Description	Mfr Code	Mfr Part Number
A2U1	1820-0070	4	IC SN74 30 N GATE	01295	SN7430N
A2U2	1820-0070		IC SN74 30 N GATE	01295	SN7430N
A2U3	1820-0174	6	IC SN74 04 N INV	01295	SN7404N
A2U4	1820-0174		IC SN74 04 N INV	01295	SN7404N
A2U5	1820-0282	4	IC SN74 86 N GATE	01295	SN7486N
A2U6	1820-0282		IC SN74 86 N GATE	01295	SN7486N
A2U7	1820-0282		IC SN74 86 N GATE	01295	SN7486N
A2U8	1820-0282		IC SN74 86 N GATE	01295	SN7486N
A2U9	1820-0070		IC SN74 30 N GATE	01295	SN7430N
A2U10	1820-0174		IC SN74 04 N INV	01295	SN7404N
A2U11	1820-0070		IC SN74 30 N GATE	01295	SN7430N
A2U12	1820-0328	1	IC SN74 02 N GATE	01295	SN7402N
A2U13	1820-0174		IC SN74 04 N INV	01295	SN7404N
A2U14	1820-0054	3	IC SN74 00 N GATE	01295	SN7400N
A2U15	1820-1277	3	IC SN74 192 N COUNTER	01295	SN74192N
A2U16	1820-0571	1	IC SN74H 10 N GATE	01295	SN74H10N
A2U17	1820-0076	1	IC SN74 76 N FLIP-FLOP	01295	SN7476N
A2U18	1820-0629	1	IC SN74S 112 N FLIP-FLOP	01295	SN74S112N
A2U19	1820-0304	1	IC SN74 72 N FLIP-FLOP	01295	SN7472N
A2U20	1820-0054		IC SN74 00 N GATE	01295	SN7400N
A2U21	1820-0174		IC SN74 04 N INV	01295	SN7404N
A2U22	1820-1277		IC SN74 192 N COUNTER	01295	SN74192N
A2U23	1820-0174		IC SN74 04 N INV	01295	SN7404N
A2U24	1820-1277		IC SN74 192 N COUNTER	01295	SN74192N
A2U25	1820-0054		IC SN74 00 N GATE	01295	SN7400N
A2X1	1200-0424	1	SOCKET IC 14 CON	23880	CSA 2900-14B
A2X2	1200-0474	1	SOCKET IC 14 CON	23880	CSA-3100-14B

Table 6-7. Frame (Option 001) Replaceable Parts List

Reference Designation	HP Part Number	Qty	Description	Mfr Code	Mfr Part Number
A1	08011-66504		(OPTION 001)	28480	08011-66504
A2	08011-66502	1	BOARD ASSEMBLY, PGEN-BURST	28480	08011-66502
A3	08011-66503	1	BOARD ASSEMBLY, BURST	28480	08011-66503
MP2	5040-7023	2	PUSH-ROD	28480	5040-7023
MP3	0370-2486	2	KNOB, PUSHBUTTON, SINGLE BURST, BURST	28480	0370-2486
MP4	08011-00207	1	PANEL, FRONT, OPT 001	28480	08011-00207
S1	3100-0552	4	SWITCH, THUMBWHEEL	28480	3100-0552

Table 6-8. Board A1 (Option 001) Replaceable Parts List

Reference Designation	HP Part Number	Qty	Description	Mfr Code	Mfr Part Number
A1	08011-66504	1	BOARD ASSEMBLY, PGEN-BURST (OPTION 001)	28480	08011-66504
A1C1	0160-2208	2	CAPACITOR-FXD 330PF +-5% 300WVDC MICA	28480	0160-2208
A1C2	0160-4210	17	CAPACITOR-FXD .022UF +-20% 50WVDC POLYE	28480	0160-4210
A1C3	0160-4210		CAPACITOR-FXD .022UF +-20% 50WVDC POLYE	28480	0160-4210
A1C4	0140-0210	1	CAPACITOR-FXD 270PF +-5% 300WVDC MICA	72136	DM15F271J0300WV1CR
A1C5	0160-2150	1	CAPACITOR-FXD 33PF +-5% 300WVDC MICA	28480	0160-2150
A1C6	0160-4210		CAPACITOR-FXD .022UF +-20% 50WVDC POLYE	28480	0160-4210
A1C7	0140-0195	1	CAPACITOR-FXD 130PF +-5% 300WVDC MICA	72136	DM15F131J0300WV1CR
A1C8	0160-3715	1	CAPACITOR-FXD .015UF +-10% 250WVDC MET	28480	0160-3715
A1C9	0160-3725	1	CAPACITOR-FXD .68UF +-10% 40WVDC MET	28480	0160-3725
A1C10	0180-0229	1	CAPACITOR-FXD; 33UF+-10% 10VDC TA-SOLID	56289	1500336X901082
A1C11	0150-3839	1	CAPACITOR-FXD 2.2UF +-10% 40WVDC MET	28480	0160-3839
A1C12	0160-4213	6	CAPACITOR-FXD .1UF +-20% 50WVDC POLYE	28480	0160-4213
A1C13	0160-4213		CAPACITOR-FXD .1UF +-20% 50WVDC POLYE	28480	0160-4213
A1C14	0160-4210		CAPACITOR-FXD .022UF +-20% 50WVDC POLYE	28480	0160-4210
A1C15	0160-4210		CAPACITOR-FXD .022UF +-20% 50WVDC POLYE	28480	0160-4210
A1C16	0160-4210		CAPACITOR-FXD .022UF +-20% 50WVDC POLYE	28480	0160-4210
A1C17	0160-C127	2	CAPACITOR-FXD 1UF +-20% 25WVDC CER	28480	0160-0127
A1C18	0160-4213		CAPACITOR-FXD .1UF +-20% 50WVDC POLYE	28480	0160-4213
A1C19	0160-4210		CAPACITOR-FXD .022UF +-20% 50WVDC POLYE	28480	0160-4210
A1C20	0140-0193	2	CAPACITOR-FXD 82PF +-5% 300WVDC MICA	72136	DM15E820J0300WV1CR
A1C21	0160-3220	1	CAPACITOR-FXD 6800PF +-5% 250WVDC MET	FR009	CKB-68
A1C22	0180-3723	1	CAPACITOR-FXD .33UF +-10% 40WVDC MET	28480	0160-3723
A1C23	0180-1746	1	CAPACITOR-FXD; 15UF+-10% 20VDC TA-SOLID	56289	1500156X902082
A1C24	0160-2208		CAPACITOR-FXD 330PF +-5% 300WVDC MICA	28480	0160-2208
A1C25	0160-4210		CAPACITOR-FXD .022UF +-20% 50WVDC POLYE	28480	0160-4210
A1C26	0160-4210		CAPACITOR-FXD .022UF +-20% 50WVDC POLYE	28480	0160-4210
A1C27	0140-0193	7	CAPACITOR-FXD 82PF +-5% 300WVDC MICA	72136	DM15E820J0300WV1CR
A1C28	0160-0174		CAPACITOR-FXD .47UF -80-20% 25WVDC CER	28480	0160-0174
A1C29	0160-0174		CAPACITOR-FXD .47UF -80-20% 25WVDC CER	28480	0160-0174
A1C30	0160-0174		CAPACITOR-FXD .47UF -80-20% 25WVDC CER	28480	0160-0174
A1C31	0160-0174		CAPACITOR-FXD .47UF -80-20% 25WVDC CER	28480	0160-0174
A1C32	0160-4210		CAPACITOR-FXD .022UF +-20% 50WVDC POLYE	28480	0160-4210
A1C33	0160-4210		CAPACITOR-FXD .022UF +-20% 50WVDC POLYE	28480	0160-4210
A1C34	0160-4210		CAPACITOR-FXD .022UF +-20% 50WVDC POLYE	28480	0160-4210
A1C35	0160-2959	2	CAPACITOR-FXD 1000PF +80-20% 1000WVDC	28480	0160-2959
A1C36	0160-0127		CAPACITOR-FXD 1UF +-20% 25WVDC CER	28480	0160-0127
A1C37	0180-2240	2	CAPACITOR-FXD; 2400UF+75-10% 25VDC AL	56289	3902485025JL2
A1C38	0180-2240		CAPACITOR-FXD; 2400UF+75-10% 25VDC AL	56289	3902485025JL2
A1C39	0160-4209	2	CAPACITOR-FXD .01UF +-20% 50WVDC POLYE	28480	0160-4209
A1C40	0160-4209		CAPACITOR-FXD .01UF +-20% 50WVDC POLYE	28480	0160-4209
A1C41	0180-0061	3	CAPACITOR-FXD; 100UF-75-10% 16VDC AL	56289	300107G0160C2
A1C42	0180-0061		CAPACITOR-FXD; 100UF-75-10% 16VDC AL	56289	300107G0160C2
A1C43	0180-0061		CAPACITOR-FXD; 100UF-75-10% 16VDC AL	56289	300107G0160C2
A1C44	0160-2306	1	CAPACITOR-FXD 27PF +-5% 300WVDC MICA	28480	0160-2306
A1C45	0160-0174		CAPACITOR-FXD .47UF -80-20% 25WVDC CER	28480	0160-0174
A1C46	0160-4210		CAPACITOR-FXD .022UF +-20% 50WVDC POLYE	28480	0160-4210
A1C47	0160-4210		CAPACITOR-FXD .022UF +-20% 50WVDC POLYE	28480	0160-4210
A1C48	0160-4210		CAPACITOR-FXD .022UF +-20% 50WVDC POLYE	28480	0160-4210
A1C49	0160-2259	1	CAPACITOR-FXD 12PF +-5% 500WVDC CER	28480	0160-2259
A1C50	0160-2959		CAPACITOR-FXD 1000PF +80-20% 1000WVDC	28480	0160-2959
A1C51	0160-4210		CAPACITOR-FXD .022UF +-20% 50WVDC POLYE	28480	0160-4210
A1C52	0160-4210		CAPACITOR-FXD .022UF +-20% 50WVDC POLYE	28480	0160-4210
A1C53	0160-4213		CAPACITOR-FXD .1UF +-20% 50WVDC POLYE	28480	0160-4213
A1C54	0160-4213		CAPACITOR-FXD .1UF +-20% 50WVDC POLYE	28480	0160-4213
A1C55	0160-4213		CAPACITOR-FXD .1UF +-20% 50WVDC POLYE	28480	0160-4213
A1C57	0160-2205	1	CAPACITOR-FXD 120PF +-5% 300WVDC MICA	28480	0160-2205
A1C58	0160-0134	1	CAPACITOR-FXD 220PF +-5% 300WVDC MICA	28480	0160-0134
A1C59	0180-2296	1	CAPACITOR-FXD 4000UF +75-10% 15VDC AL	28480	0180-2296
A1C60	0160-0174		CAPACITOR-FXD .47UF -80-20% 25WVDC CER	28480	0160-0174
A1C61	0160-0174		CAPACITOR-FXD .47UF -80-20% 25WVDC CER	28480	0160-0174
A1C62	0180-3470		CAPACITOR-FXD 01UF +50VDC CER	28480	1901-0040
A1CR1	1901-0040	13	DIODE-SWITCHING 30V 50NA 2NS DO-35	28480	1901-0040
A1CR2	1901-0040		DIODE-SWITCHING 30V 50NA 2NS DO-35	28480	1901-0040
A1CR3	1901-0040		DIODE-SWITCHING 30V 50NA 2NS DO-35	28480	1901-0040
A1CR4	1901-0040		DIODE-SWITCHING 30V 50NA 2NS DO-35	28480	1901-0040
A1CR5	1901-0040		DIODE-SWITCHING 30V 50NA 2NS DO-35	28480	1901-0040
A1CR6	1902-0041	4	DIODE-ZNR 5.11V 5% DO-7 PD=.4W TC=-.009%	04713	SZ 10939-98
A1CR7	1901-0040		DIODE-SWITCHING 30V 50NA 2NS DO-35	28480	1901-0040
A1CR8	1902-0041		DIODE-ZNR 5.11V 5% DO-7 PD=.4W TC=-.009%	04713	SZ 10939-98
A1CR9	1902-0041		DIODE-ZNR 5.11V 5% DO-7 PD=.4W TC=-.009%	04713	SZ 10939-98
A1CR10	1902-3104	2	DIODE-ZNR 5.62V 5% DO-7 PD=.4W TC=+.016%	04713	SZ 10939-110

Table 6-8. (cont'd) Board A1 (Option 001) Replaceable Parts List

Reference Designation	HP Part Number	Qty	Description	Mfr Code	Mfr Part Number
A1CR11	1902-3104		DIODE-ZNR 5.62V 5% DO-7 PD=.4W TC=+.016%	04713	SZ 10939-110
A1CR12	1901-0040		DIODE-SWITCHING 30V 50NA 2NS DO-35	28480	1901-0040
A1CR13	1901-0040		DIODE-SWITCHING 30V 50NA 2NS DO-35	28480	1901-0040
A1CR14	1901-0040		DIODE-SWITCHING 30V 50NA 2NS DO-35	28480	1901-0040
A1CR15	1901-0040		DIODE-SWITCHING 30V 50NA 2NS DO-35	28480	1901-0040
A1CR16	1901-0040		DIODE-SWITCHING 30V 50NA 2NS DO-35	28480	1901-0040
A1CR17	1901-0159	9	DIODE-PWR RECT 400V 750NA DO-41	04713	SR1358-4
A1CR18	1901-0159		DIODE-PWR RECT 400V 750NA DO-41	04713	SR1358-4
A1CR19	1901-0159		DIODE-PWR RECT 400V 750NA DO-41	04713	SR1358-4
A1CR20	1901-0159		DIODE-PWR RECT 400V 750NA DO-41	04713	SR1358-4
A1CR21	1901-0159		DIODE-PWR RECT 400V 750NA DO-41	04713	SR1358-4
A1CR22	1901-0159		DIODE-PWR RECT 400V 750NA DO-41	04713	SR1358-4
A1CR23	1901-0159		DIODE-PWR RECT 400V 750NA DO-41	04713	SR1358-4
A1CR24	1901-0159		DIODE-PWR RECT 400V 750NA DO-41	04713	SR1358-4
A1CR25	1901-0159		DIODE-PWR RECT 400V 750NA DO-41	04713	SR1358-4
A1CR25	1902-1291	1	DIODE-ZNR 1N5338B 5.1V 5% PD=5W IR=1UA	04713	1N5338B
A1CR26	1901-0040		DIODE-SWITCHING 30V 50NA 2NS DO-35	28480	1901-0040
A1CR27	1901-0040		DIODE-SWITCHING 30V 50NA 2NS DO-35	28480	1901-0040
A1CR29	1901-0363	1	DIODE-MULT FULL WAVE BRIDGE RECTIFIER	04713	SDA 10185-3
A1CR30	1901-0533	1	DIODE-SCHOTTKY	26480	1901-0533
A1CR31	1902-0041	1	DIODE-ZNR 5.11V 5% DO-7 PD=.4W TC=-.009%	04713	SZ 10939-98
A1L1	9140-0096	1	COIL FXD MOLDED RF CHOKE 1UH 10%		
A1L2	9140-0096	2	COIL FXD MOLDED RF CHOKE 1UH 20%		
A1L3	9100-1612		COIL-FXD MOLDED RF CHOKE .33UH 20%	24226	15/330
A1L4	9100-1657	2	COIL-FXD MOLDED RF CHOKE 1.5MH 5%	24226	22/154
A1L5	9100-1657		COIL-FXD MOLDED RF CHOKE 1.5MH 5%	24226	22/154
A1L6	9170-0029	3	CORE-SHIELDING BEAD	02114	56-590-65A2/4A
A1L7	9170-0029		CORE-SHIELDING BEAD	02114	56-590-65A2/4A
A1L8	9170-0029		CORE-SHIELDING BEAD	02114	56-590-65A2/4A
A1MP1	08011-01101	1	HT-SINK FOR Q33, Q34, Q37, Q38, Q7	28480	08011-01101
A1MP2	08011-01102	1	HT-SINK FOR Q27, Q28, Q29, Q30	28480	08011-01102
A1Q1	1854-0053	3	TRANSISTOR NPN 2N2218 SI TO-5 PD=800MW	04713	2N2218
A1Q2	1854-0053		TRANSISTOR NPN 2N2218 SI TO-5 PD=800MW	04713	2N2218
A1Q3	1854-0053		TRANSISTOR NPN 2N2218 SI TO-5 PD=800MW	04713	2N2218
A1Q4	1853-0089	7	TRANSISTOR PNP 2N4917 SI PD=200MW	07263	2N4917
A1Q5	1854-0215	5	TRANSISTOR NPN SI PD=350MW FT=300MHZ	04713	SPS 3611
A1Q6	1854-0215		TRANSISTOR NPN SI PD=350MW FT=300MHZ	07263	2N4917
A1Q7	1853-0036		TRANSISTOR PNP 2N4917 SI PD=200MW	07263	2N4917
A1Q8	1853-0089	7	TRANSISTOR PNP 2N4917 SI PD=200MW	28480	1853-0036
A1Q9	1853-0036		TRANSISTOR PNP SI PD=310MW FT=250MHZ	04713	SPS 3611
A1Q10	1854-0215		TRANSISTOR NPN SI PD=350MW FT=300MHZ	28480	1853-0036
A1Q11	1853-0036		TRANSISTOR PNP SI PD=310MW FT=250MHZ	07263	2N4917
A1Q12	1853-0036		TRANSISTOR PNP 2N4917 SI PD=200MW	28480	2N4917
A1Q13	1853-0036		TRANSISTOR PNP SI PD=310MW FT=250MHZ	28480	1853-0036
A1Q14	1853-0036		TRANSISTOR PNP SI PD=310MW FT=250MHZ	28480	1853-0036
A1Q15	1853-0089		TRANSISTOR PNP 2N4917 SI PD=200MW	07263	2N4917
A1Q16	1853-0089		TRANSISTOR PNP 2N4917 SI PD=200MW	07263	2N4917
A1Q17	1854-0630	4	TRANSISTOR NPN SI TO-52 PD=360MW	04713	5S2677
A1Q18	1854-0630		TRANSISTOR NPN SI TO-52 PD=360MW	04713	5S2077
A1Q19	1853-0089		TRANSISTOR PNP 2N4917 SI PD=200MW	07263	2N4917
A1Q20	1853-0036		TRANSISTOR PNP SI PD=310MW FT=250MHZ	28480	1853-0036
A1Q21	1854-0630		TRANSISTOR NPN SI TO-52 PD=360MW	04713	5S2077
A1Q22	1854-0630		TRANSISTOR NPN SI TO-52 PD=360MW	04713	5S2077
A1Q23	1853-0357	2	TRANSISTOR PNP SI TO-18 PD=360MW	28480	1853-0357
A1Q24	1853-0357		TRANSISTOR PNP SI TO-18 PD=360MW	28480	1853-0357
A1Q25	1853-0315	1	TRANSISTOR PNP SI TO-39 PD=1W FT=1GHZ	28480	1853-0315
A1Q25	1205-0061	2	HEAT-DISSIPATOR SGL TO-5/T0-39 PKG	28480	1205-0061
A1Q26	1854-0498	1	TRANSISTOR TO-39 PD=1W	28480	1854-0498
A1Q27	1205-0061		HEAT-DISSIPATOR SGL TO-5/T0-39 PKG	28480	1205-0061
A1Q28	1853-0012	3	TRANSISTOR PNP 2N2904A SI TO-5 PD=600MW	01295	2N2904A
A1Q29	1853-0012		TRANSISTOR PNP 2N2904A SI TO-5 PD=600MW	01295	2N2904A
A1Q30	1854-0213	2	TRANSISTOR NPN 2N2538 SI TO-5 PD=800MW	28480	1854-0213
A1Q31	1853-0036		TRANSISTOR PNP SI PD=310MW FT=250MHZ	28480	1853-0036
A1Q32	1854-0215		TRANSISTOR NPN SI PD=350MW FT=300MHZ	04713	SPS 3611
A1Q33	1854-0402	1	TRANSISTOR NPN SI PD=30W FT=3MHZ	28480	1854-0402
A1Q34	1853-0254	1	TRANSISTOR PNP SI PD=30W FT=3MHZ	28480	1853-0254
A1Q35	1854-0215		TRANSISTOR NPN SI PD=350MW FT=300MHZ	04713	SPS 3611
A1Q36	1853-0012	2	TRANSISTOR PNP 2N2904A SI TO-5 PD=600MW	01295	2N2904A
A1Q37	1853-0356		TRANSISTOR PNP SI PD=65W FT=3MHZ	28480	1853-0356
A1Q38	1853-0356		TRANSISTOR PNP SI PD=65W FT=3MHZ	28480	1853-0356
A1Q40	1853-0036		TRANSISTOR PNP SI PD=310MW FT=250MHZ	28480	1853-0036
A1R1	0758-0093	1	RESISTOR 56 5% .25W F TC=0+-100	24546	C5-1/4-T0-56R0-J
A1R2	0698-3242	4	RESISTOR 357 1% .125W F TC=0+-100	16299	C4-1/8-T0-357R-F
A1R3	0757-0284	2	RESISTOR 150 1% .125W F TC=0+-100	24546	C4-1/8-T0-151-F
A1R4	0757-0427	1	RESISTOR 1.5K 1% .125W F TC=0+-100	24546	C4-1/8-T0-1501-F
A1R5	0757-0398	1	RESISTOR 75 1% .125W F TC=0+-100	24546	C4-1/8-T0-75R0-F

Table 6-8. (cont'd) Board A1 (Option 001) Replaceable Parts List

Reference Designation	HP Part Number	Qty	Description	Mfr Code	Mfr Part Number
A1R6	0698-3242		RESISTOR 357 1% .125W F TC=0+-100	16299	C4-1/8-T0-357R-F
A1R7	0757-0400	2	RESISTOR 90.9 1% .125W F TC=0+-100	24546	C4-1/8-T0-90R9-F
A1R8	0757-0442	2	RESISTOR 10K 1% .125W F TC=0+-100	24546	C4-1/8-T0-1002-F
A1R9	0757-0283	2	RESISTOR 2K 1% .125W F TC=0+-100	24546	C4-1/8-T0-2001-F
A1R10	0757-0403	1	RESISTOR 121 1% .125W F TC=0+-100	24546	C4-1/8-T0-121R-F
A1R11	0698-3151	1	RESISTOR 2.87K 1% .125W F TC=0+-100	16299	C4-1/8-T0-2871-F
A1R12	0757-0428	7	RESISTOR 1.62K 1% .125W F TC=0+-100	24546	C4-1/8-T0-1621-F
A1R13	0757-0407	4	RESISTOR 200 1% .125W F TC=0+-100	24546	C4-1/8-T0-201-F
A1R14	0757-0405	3	RESISTOR 162 1% .125W F TC=0+-100	24546	C4-1/8-T0-162R-F
A1R15	0757-0394	2	RESISTOR 51.1 1% .125W F TC=0+-100	24546	C4-1/8-T0-51R1-F
A1R16	0758-0068	1	RESISTOR 910 5% .25W F TC=0+-100	24546	C5-1/4-T0-911-J
A1R17	0757-0411	3	RESISTOR 332 1% .125W F TC=0+-100	24546	C4-1/8-T0-332R-F
A1R18	0757-0416	3	RESISTOR 511 1% .125W F TC=0+-100	24546	C4-1/8-T0-511R-F
A1R19	0757-0437	2	RESISTOR 4.75K 1% .125W F TC=0+-100	24546	C4-1/8-T0-4751-F
A1R20	0757-0422	2	RESISTOR 909 1% .125W F TC=0+-100	24546	C4-1/8-T0-909R-F
A1R21	0757-0273	3	RESISTOR 3.01K 1% .125W F TC=0+-100	24546	C4-1/8-T0-3011-F
A1R22	0757-0273		RESISTOR 3.01K 1% .125W F TC=0+-100	24546	C4-1/8-T0-3011-F
A1R23	0757-0428		RESISTOR 1.62K 1% .125W F TC=0+-100	24546	C4-1/8-T0-1621-F
A1R24	0757-0397	3	RESISTOR 68.1 1% .125W F TC=0+-100	24546	C4-1/8-T0-68R1-F
A1R25	0757-0381	1	RESISTOR 15 1% .125W F TC=0+-100	19701	MF4C1/8-T0-15R0-F
A1R26	0757-0438	5	RESISTOR 5.11K 1% .125W F TC=0+-100	24546	C4-1/8-T0-5111-F
A1R27	0757-0437		RESISTOR 4.75K 1% .125W F TC=0+-100	24546	C4-1/8-T0-4751-F
A1R28	0757-0442		RESISTOR 10K 1% .125W F TC=0+-100	24546	C4-1/8-T0-1002-F
A1R29	0757-0401	7	RESISTOR 100 1% .125W F TC=0+-100	24546	C4-1/8-T0-101-F
A1R30	0693-3245	1	RESISTOR 20.5K 1% .125W F TC=0+-100	16299	C4-1/8-T0-2052-F
A1R31	0757-0400	2	RESISTOR 243 1% .125W F TC=0+-100	24546	C4-1/8-T0-243R-F
A1R32	0757-0283		RESISTOR 2K 1% .125W F TC=0+-100	24546	C4-1/8-T0-2001-F
A1R33	0757-0230	2	RESISTOR 5.62K 1% .125W F TC=0+-100	24546	C4-1/8-T0-5621-F
A1R34	0757-0431	4	RESISTOR 2.43K 1% .125W F TC=0+-100	24546	C4-1/8-T0-2431-F
A1R35	0757-0430	1	RESISTOR 2.21K 1% .125W F TC=0+-100	24546	C4-1/8-T0-2211-F
A1R36	0757-0401		RESISTOR 100 1% .125W F TC=0+-100	24546	C4-1/8-T0-101-F
A1R37	0757-0407		RESISTOR 200 1% .125W F TC=0+-100	24546	C4-1/8-T0-201-F
A1R38	0757-0410	2	RESISTOR 301 1% .125W F TC=0+-100	24546	C4-1/8-T0-301R-F
A1R39	0757-0431		RESISTOR 2.43K 1% .125W F TC=0+-100	24546	C4-1/8-T0-2431-F
A1R40	0757-0435	1	RESISTOR 3.92K 1% .125W F TC=0+-100	24546	C4-1/8-T0-3921-F
A1R41	0757-0414	1	RESISTOR 432 1% .125W F TC=0+-100	24546	C4-1/8-T0-432R-F
A1R42	0757-0420	1	RESISTOR 750 1% .125W F TC=0+-100	24546	C4-1/8-T0-751-F
A1R43	0757-0230		RESISTOR 5.62K 1% .125W F TC=0+-100	24546	C4-1/8-T0-5621-F
A1R44	0757-0410		RESISTOR 301 1% .125W F TC=0+-100	24546	C4-1/8-T0-301R-F
A1R45	0757-0799	1	RESISTOR 121 1% .5W F TC=0+-100	19701	MF7C-1/2-T0-121R-F
A1R46	0757-0284		RESISTOR 150 1% .125W F TC=0+-100	24546	C4-1/8-T0-151-F
A1R47	0693-3441	1	RESISTOR 215 1% .125W F TC=0+-100	16299	C4-1/8-T0-215P-F
A1R48	0757-0408		RESISTOR 243 1% .125W F TC=0+-100	24546	C4-1/8-T0-243R-F
A1R49	0757-0409	2	RESISTOR 274 1% .125W F TC=0+-100	24546	C4-1/8-T0-274R-F
A1R50	0757-0428		RESISTOR 1.62K 1% .125W F TC=0+-100	24546	C4-1/8-T0-1621-F
A1R51	0757-0386	2	RESISTOR 24.3 1% .125W F TC=0+-100	19701	MF4C1/8-T0-24R3-F
A1R52	0757-0422		RESISTOR 909 1% .125W F TC=0+-100	24546	C4-1/8-T0-909R-F
A1R53	0757-0273		RESISTOR 3.01K 1% .125W F TC=0+-100	24546	C4-1/8-T0-3011-F
A1R54	0757-0392	1	RESISTOR 43.2 1% .125W F TC=0+-100	24546	C4-1/8-T0-43R2-F
A1R55	0757-0401		RESISTOR 100 1% .125W F TC=0+-100	24546	C4-1/8-T0-101-F
A1R56	0757-0400		RESISTOR 90.9 1% .125W F TC=0+-100	24546	C4-1/8-T0-90R9-F
A1R57	0757-0401	1	RESISTOR 100 1% .125W F TC=0+-100	24546	C4-1/8-T0-101-F
A1R58	0758-0002	1	RESISTOR 560 5% .25W F TC=0+-100	24546	C5-1/4-T0-561-J
A1R59	0758-0054	1	RESISTOR 330 5% .25W F TC=0+-100	24546	C5-1/4-T0-331-J
A1R61	0757-0280	3	RESISTOR 1K 1% .125W F TC=0+-100	24546	C4-1/8-T0-1001-F
A1R62	0757-0409		RESISTOR 274 1% .125W F TC=0+-100	24546	C4-1/8-T0-274R-F
A1R63	0757-0397		RESISTOR 68.1 1% .125W F TC=0+-100	24546	C4-1/8-T0-68R1-F
A1R63	0693-3262	2	RESISTOR 40.2 1% .125W F TC=0+-100	16299	C4-1/8-T0-4022-F
A1R63	0757-0401		RESISTOR 100 1% .125W F TC=0+-100	24546	C4-1/8-T0-68R1-F
A1R64	0757-0397		RESISTOR 68.1 1% .125W F TC=0+-100	16299	C4-1/8-T0-4022-F
A1R64	0698-3262		RESISTOR 40.2 1% .125W F TC=0+-100	16299	C4-1/8-T0-4022-F
A1R64	0757-0384		RESISTOR 20 1% .125W F TC=0+-100	16299	C4-1/8-T0-357R-F
A1R65	0698-3242		RESISTOR 357 1% .125W F TC=0+-100	24546	C4-1/8-T0-101-F
A1R66	0757-0401		RESISTOR 100 1% .125W F TC=0+-100	24546	C4-1/8-T0-101-F
A1R67	0757-0401		RESISTOR 100 1% .125W F TC=0+-100	16299	C4-1/8-T0-357R-F
A1R68	0698-3242		RESISTOR 357 1% .125W F TC=0+-100	11502	TF07-1/4-T0-5R1-J
A1R69	0698-7521	4	RESISTOR 5.1 5% .25W F TC=0+-100	11502	TF07-1/4-T0-5R1-J
A1R70	0698-7521		RESISTOR 5.1 5% .25W F TC=0+-100	11502	TF07-1/4-T0-5R1-J
A1R71	0757-0431		RESISTOR 2.43K 1% .125W F TC=0+-100	24546	C4-1/8-T0-2431-F
A1R73	0698-7521		RESISTOR 5.1 5% .25W F TC=0+-100	11502	TF07-1/4-T0-5R1-J
A1R74	0698-7521		RESISTOR 5.1 5% .25W F TC=0+-100	24546	C5-1/4-T0-30R1-F
A1R75	0757-0500	4	RESISTOR 30.1 1% .25W F TC=0+-100	24546	C5-1/4-T0-30R1-F
A1R76	0757-0500		RESISTOR 30.1 1% .25W F TC=0+-100	24546	C5-1/4-T0-30R1-F
A1R77	0757-0500		RESISTOR 30.1 1% .25W F TC=0+-100	24546	C5-1/4-T0-30R1-F
A1R78	0757-0500		RESISTOR 30.1 1% .25W F TC=0+-100	24546	C5-1/4-T0-30R1-F
A1R79	0757-0280		RESISTOR 1K 1% .125W F TC=0+-100	24546	C4-1/8-T0-1001-F
A1R79	0757-0416		RESISTOR 511 1% .125W F TC=0+-100	24546	C4-1/8-T0-511R-F

Table 6-8. (cont'd) Board A1 (Option 001) Replaceable Parts List

Reference Designation	HP Part Number	Qty	Description	Mfr Code	Mfr Part Number	
A1R80	0757-0280	2	RESISTOR 1K 1% .125W F TC=0+-100	24546	C4-1/8-T0-1001-F	
A1R80	0757-0416		RESISTOR 511 1% .125W F TC=0+-100	24546	C4-1/8-T0-511R-F	
A1R81	2100-2799		RESISTOR, VAR 2.2K 20% 0.5W LIN CC	28480	2100-2799	
A1R82	0757-0438		RESISTOR 5.11K 1% .125W F TC=0+-100	24546	C4-1/8-T0-5111-F	
A1R83	0757-0438		RESISTOR 5.11K 1% .125W F TC=0+-100	24546	C4-1/8-T0-5111-F	
A1R84	2100-2799	2	RESISTOR, VAR 2.2K 20% 0.5W LIN CC	28480	2100-2799	
A1R85	0698-5876		RESISTOR 10 5% .25W F TC=0+-100	24546	C5-1/4-T0-10R0-J	
A1R86	0757-0407		RESISTOR 200 1% .125W F TC=0+-100	24546	C4-1/8-T0-201-F	
A1R87	0757-0407		RESISTOR 200 1% .125W F TC=0+-100	24546	C4-1/8-T0-201-F	
A1R88	0698-5876		RESISTOR 10 5% .25W F TC=0+-100	24546	C5-1/4-T0-10R0-J	
A1R89	0757-0431	1	RESISTOR 2.43K 1% .125W F TC=0+-100	24546	C4-1/8-T0-2431-F	
A1R92	0757-0346		RESISTOR 10 1% .125W F TC=0+-100	24546	C4-1/8-T0-10R0-F	
A1R93	0757-0401		RESISTOR 100 1% .125W F TC=0+-100	24546	C4-1/8-T0-101-F	
A1R94	0757-0386		RESISTOR 24.3 1% .125W F TC=0+-100	19701	MF4C1/8-T0-24R3-F	
A1R95	0757-0374		RESISTOR 51.1 1% .125W F TC=0+-100	24546	C4-1/8-T0-51R1-F	
A1R96	0766-0025	2	RESISTOR 101 2% 3W MO TC=0+-250	27167	FP3-3-250-101R-G	
A1R97	0766-0025		RESISTOR 101 2% 3W MO TC=0+-250	27167	FP3-3-250-101R-G	
A1R98	0761-0035	2	RESISTOR 150 5% 1W MO TC=0+-200	24546	FP32-1-T00-151-J	
A1R99	0758-0080		RESISTOR 75 5% .25W F TC=0+-100	24546	C5-1/4-T0-7502-J	
A1R100	0758-0080	2	RESISTOR 75 5% .25W F TC=0+-100	24546	C5-1/4-T0-7502-J	
A1R101	0761-0035	2	RESISTOR 150 5% 1W MO TC=0+-200	24546	FP32-1-T00-151-J	
A1R102	0758-0082		RESISTOR 130 5% .25W F TC=0+-100	24546	C5-1/4-T0-131-J	
A1R103	0758-0082		RESISTOR 130 5% .25W F TC=0+-100	24546	C5-1/4-T0-131-J	
A1R104	0757-1060		1	RESISTOR 196 1% .5W F TC=0+-100	19701	MF7C1/2-T0-196R-F
A1R105	0698-4825		1	RESISTOR 64.9 1% .5W F TC=0+-100	24546	NA6
A1R107	0757-0438	2	RESISTOR 5.11K 1% .125W F TC=0+-100	24546	C4-1/8-T0-5111-F	
A1R108	0757-0438		RESISTOR 5.11K 1% .125W F TC=0+-100	24546	C4-1/8-T0-5111-F	
A1R109	0698-3620		RESISTOR 100 5% 2W MO TC=0+-200	24546	FP42-2-T00-100R-J	
A1R110	0698-3620		RESISTOR 100 5% 2W MO TC=0+-200	24546	FP42-2-T00-100R-J	
A1R111	2100-3104		1	RESISTOR, VAR 50 OHM 10% 5W, CC	01121	0BD
A1R112	0698-5880	2	RESISTOR 15 5% .25W F TC=0+-100	24546	C5-1/4-T0-15R0-J	
A1R113	0698-3616		RESISTOR 62 5% 2W MO TC=0+-200	16299	FP42-2-T00-62R0-J	
A1R114	0757-0421	3	RESISTOR 825 1% .125W F TC=0+-100	24546	C4-1/8-T0-825R-F	
A1R115	0757-0421		RESISTOR 825 1% .125W F TC=0+-100	24546	C4-1/8-T0-825R-F	
A1R116	0757-0411		RESISTOR 332 1% .125W F TC=0+-100	24546	C4-1/8-T0-332R-F	
A1R117	0757-0411	2	RESISTOR 332 1% .125W F TC=0+-100	24546	C4-1/8-T0-332R-F	
A1R118	0757-0421		RESISTOR 825 1% .125W F TC=0+-100	24546	C4-1/8-T0-825R-F	
A1R119	0698-5880		RESISTOR 15 5% .25W F TC=0+-100	24546	C5-1/4-T0-15R0-J	
A1R120	0812-0021		RESISTOR .47 5% 3W PW TC=0+-90	91637	CW281-3-T2-47/100-J	
A1R123	0812-0021		RESISTOR .47 5% 3W PW TC=0+-90	91637	CW281-3-T2-47/100-J	
A1R124	0757-0428	2	RESISTOR 1.62K 1% .125W F TC=0+-100	24546	C4-1/8-T0-1621-F	
A1R125	2100-2800		R:VAR CERMET 1000 OHM 20%	28480	2100-2800	
A1R126	0757-0428		RESISTOR 1.62K 1% .125W F TC=0+-100	24546	C4-1/8-T0-1621-F	
A1R127	0757-0428		RESISTOR 1.62K 1% .125W F TC=0+-100	24546	C4-1/8-T0-1621-F	
A1R128	2100-2800		R:VAR CERMET 1000 OHM 20%	28480	2100-2800	
A1R129	0757-0428	2	RESISTOR 1.62K 1% .125W F TC=0+-100	24546	C4-1/8-T0-1621-F	
A1R130	0757-0405		RESISTOR 162 1% .125W F TC=0+-100	24546	C4-1/8-T0-162R-F	
A1R131	2100-2739		R:VAR 220 OHM	28480	2100-2739	
A1R132	0698-4431		RESISTOR 2.05K 1% .125W F TC=0+-100	16299	C4-1/8-T0-2051-F	
A1R133	2100-2739		R:VAR 220 OHM	28480	2100-2739	
A1R134	0757-0405	4	RESISTOR 162 1% .125W F TC=0+-100	24546	C4-1/8-T0-162R-F	
A1R135	0698-5137		RESISTOR 47 5% .25W F TC=0+-100	24546	C5-1/4-T0-47R0-D	
A1R136	0698-5137		RESISTOR 47 5% .25W F TC=0+-100	24546	C5-1/4-T0-47R0-D	
A1R137	0698-5137		RESISTOR 47 5% .25W F TC=0+-100	24546	C5-1/4-T0-47R0-D	
A1R138	0698-5137		RESISTOR 47 5% .25W F TC=0+-100	24546	C5-1/4-T0-47R0-D	
A1R139	0757-0384	1	RESISTOR 20 1% .125W F TC=0+-100	24546	C5-1/4-T0-20R0-D	
A1S1	3101-0597		SWITCH-PB 9STA .394 IN-CTRS .25A 120VAC	28480	3101-0597	
A1S2	3101-0596		SWITCH-PB 3STA INTLM .394 IN-CTRS .25A	28480	3101-0596	
A1S3	3101-0595		SWITCH-PB 5STA .394 IN-CTRS .25A 120VAC	28480	3101-0595	
A1S4	3101-0593		SWITCH-PB 5STA .394 IN-CTRS .25A 120VAC	28480	3101-0593	
A1S5	3101-0598	SWITCH-PB DPDT MOM	28480	3101-0598		
A1S6	3101-0555	1	SWITCH-PB DPDT ALTN 4A 250VAC	28480	3101-0555	
A1S7	3101-0629		SWITCH-SL DPOT-NS MINTR 2A 250VAC PC	28480	3101-0629	
A1S8	3101-0629		SWITCH-SL DPOT-NS MINTR 2A 250VAC PC	28480	3101-0629	
A1S9	3101-0594		SWITCH-PB 2STA .394 IN-CTRS .25A 120VAC	28480	3101-0594	
A1U1	1826-0092	1	IC AMPL	28480	1826-0092	
A1U2	1820-0111		IC MC 1458 50 N GATE	01295	SN74H50N	
A1U3	1820-0065		IC SN74 70 N FLIP-FLOP	01295	SN7470N	
A1U4	1820-0380		IC SN74H 53 N GATE	01295	SN74H53N	
A1U5	1820-0195		IC RGLTR	07263	723HC	
A1U6	1820-0196	1	IC RGLTR	07263	723HC	
A1U7	1826-0122		IC RGLTR	07263	7805UC	
A1W1	8120-1459	1	CABLE RIBBON	28480	8120-1459	
A1X1	1251-2499		CONNECTOR FOR W1	76381	3406-0000	

Removal of Board A2 (Burst Option) for Troubleshooting

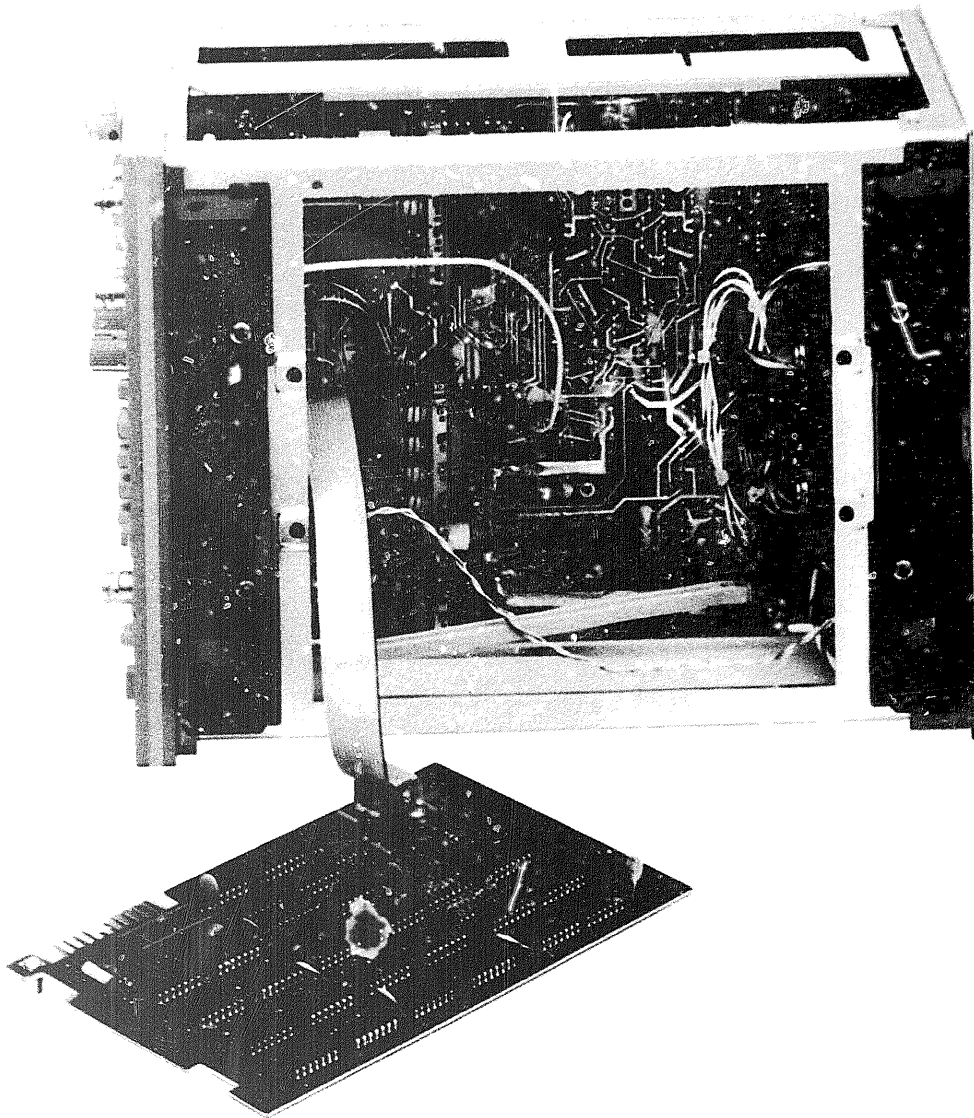

Board A2 is removed, as follows, in preparation for the troubleshooting procedure:

1. Remove screw fixing board A2 to the frame.
2. Place 8011A on its side
3. Remove board A2, leaving ribbon cable, W1 connected (see photograph above)

Table 6-9. Burst Option Troubleshooting

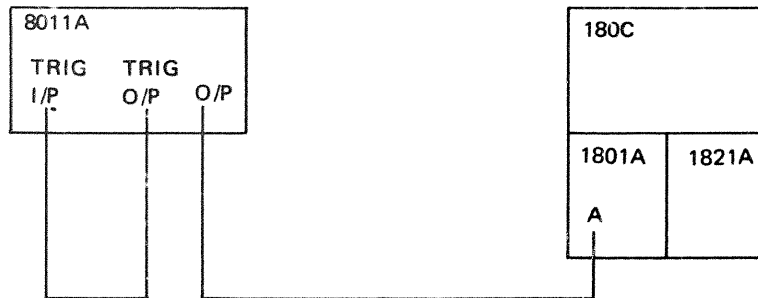

1. With oscilloscope set to $1\mu\text{s}/\text{division}$, set the 8011A output to exactly 1 MHz with minimum width.
2. Set 8011A to Burst Mode.
3. Connect the 8011A TRIGGER OUTPUT to the 8011A TRIGGER INPUT.
4. Disconnect the base connection of transistor A2Q4 and leave as 'open base'.
5. Disconnect pin 13 of A2U12 from socket X2 and leave as 'open circuit'.
6. Wire-connect the open track (from which A2U12 pin 13 is disconnected) to floating ground.
7. Set 1821A to internal trigger.
8. Check the waveforms detailed in the following list:

Test Point	8011 Board A2 Reference Point	Oscilloscope Screen	180C Time/Div	180C Trigger Slope
1	U18 Pin 1		$1\mu\text{s}$	\ominus
2	U15 Pin 4		$1\mu\text{s}$	\ominus
3	U22 Pin 4		$10\mu\text{s}$	\ominus
4	U24 Pin 4		0.1ms	\ominus
5	U24 Pin 7		1ms	\ominus
6	U2 Pin 8		$10\mu\text{s}$	\ominus
7	U1 Pin 8		1ms	\ominus
8	U12 Pins 10, 11		1ms	\oplus
9	U11 Pin 8		$10\mu\text{s}$	\ominus
10	U9 Pin 8		1ms	\ominus
11	U19 Pin 2		1ms	\ominus
12	Q3 emitter		1ms	\oplus
13	U19 Pin 13		$1\mu\text{s}$	\ominus
14	U19 Pin 6		1ms	\oplus
15	Q3 collector		1ms	\oplus
16	U19 Pin 8		1ms	\ominus
17	U12 Pin 13		1ms	\oplus

NOTES: 1. * Only for Burst number greater than 0000
 2. Some duty cycles are difficult to see on oscilloscope screen

9. Set the 8011A to SYM output and check all power supply voltages.

10. Check that all the A2J1 pins which are normally connected to the thumbwheel switches (but now disconnected) are high.

NOTES

- 1 Outputs from the exclusive OR gates MC 6 to MC 8 are given in the Boolean Algebra form e.g. $(B0 \cdot \bar{C}80 + 80 \cdot C80)$ means that the output is "true" when either 80 is present and C80 is not present or when 80 is not present and C80 is present
- 2 Normally components A2 C17 and A2 C18 are not needed, but on occasions when they are needed, both values are 100pF
- 3 Pin numbers marked between cable W1 and socket A2 X1 refer to the X1 pin number (pin 1 of socket X1 is marked by a solder spot on the component side of A2) The corresponding cable W1 pin number is marked in brackets
- 4  indicates a trouble-shooting test point (see table facing)

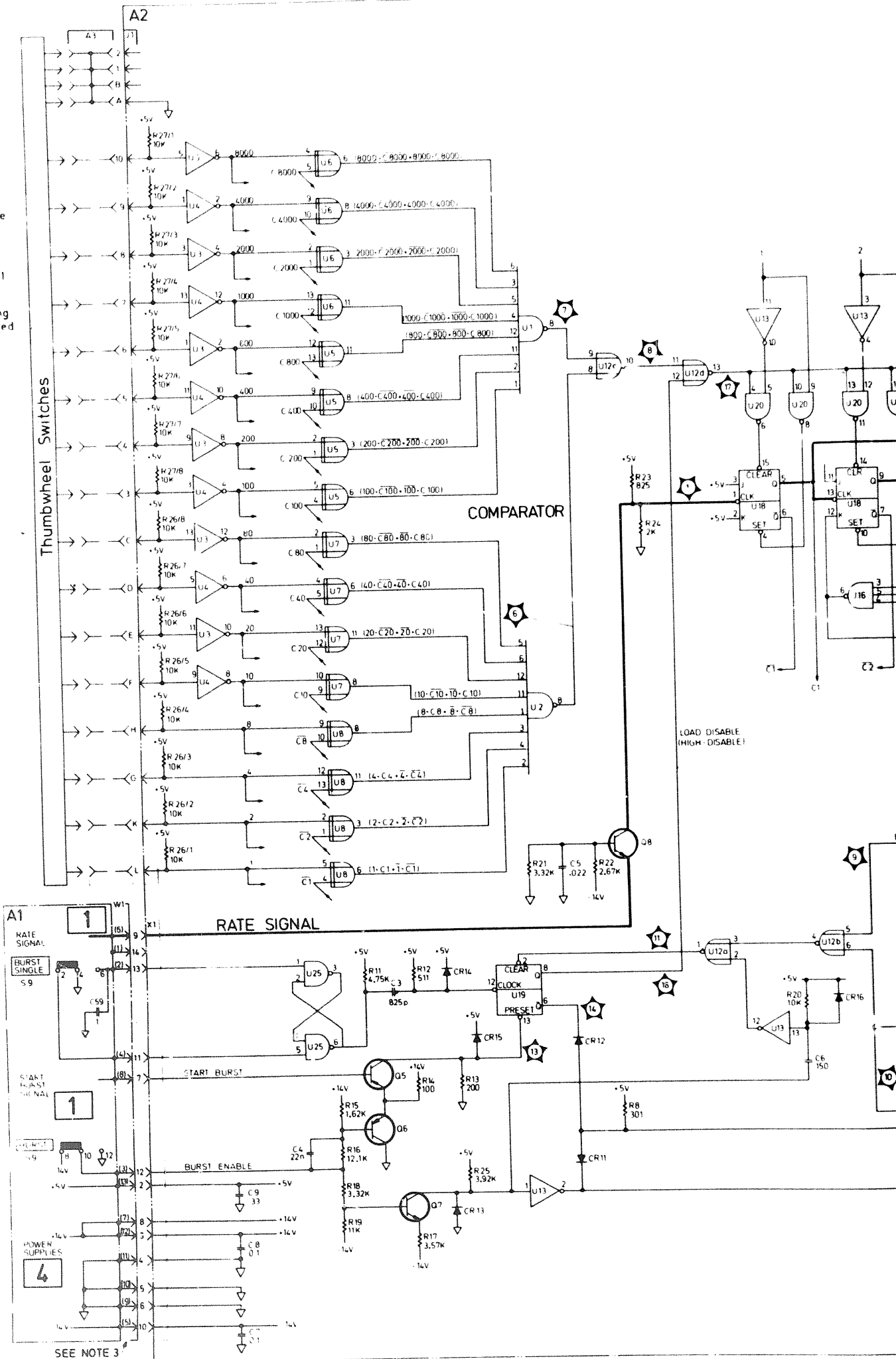

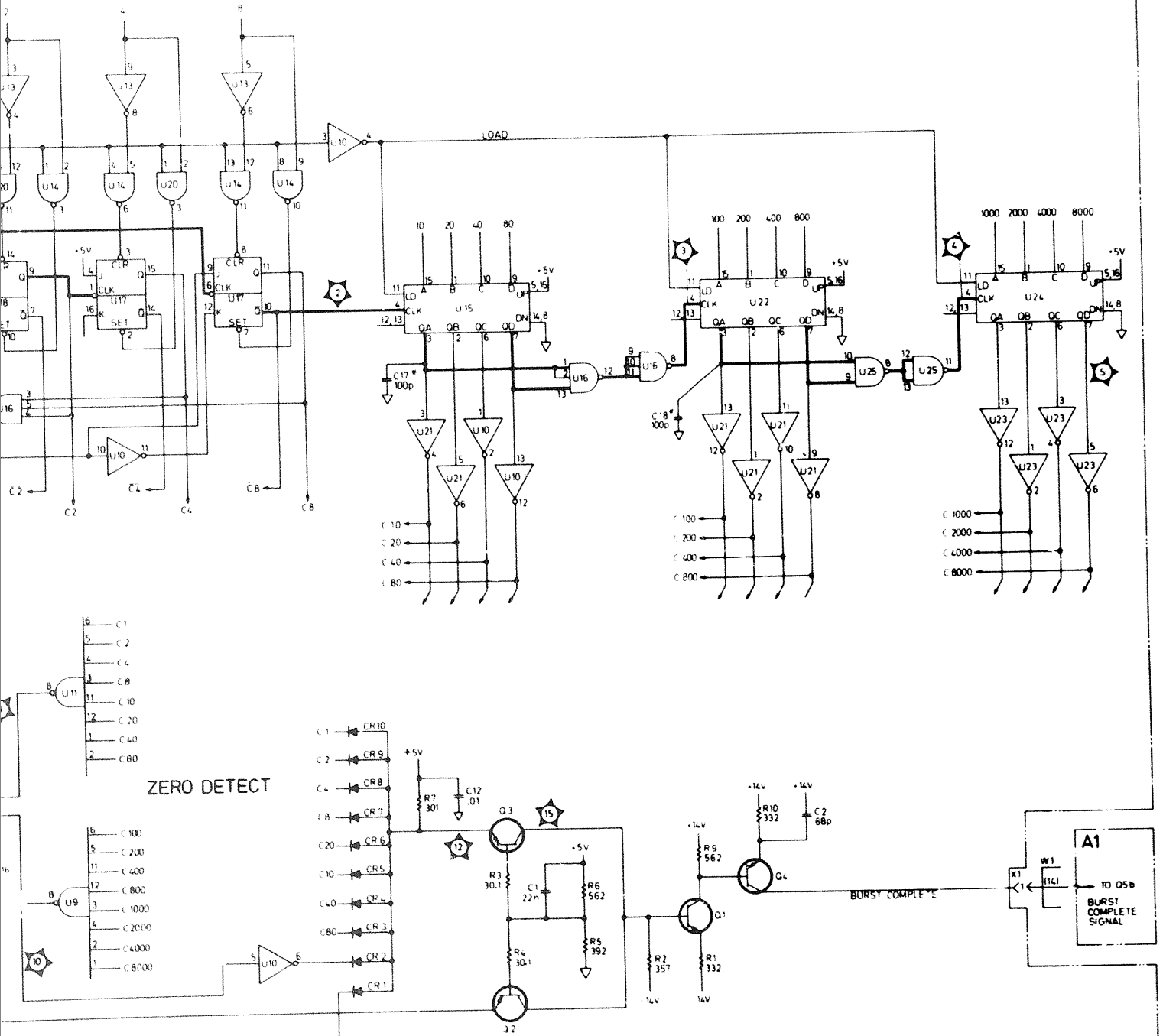

ZERO DETECT

NOTE
 ALL SWITCHES ARE SHOWN
 IN THE "OUT" POSITION

EXT OUT IN

PUSH IN TO SELECT MODE OR RANGE

5
 OPTION 001
 BURST BOARD

7-1 INTRODUCTION

7-2 This section contains backdating information which adapts this manual to instruments with serial numbers lower than that shown on the inside of the front cover.

NOTES: 1. The backdating information does not include changes detailed in Service Notes 8011A-G1 to 8011A-G5. These changes are also serial number related, and should be incorporated (in manual and instrument) in addition to the backdating information.

2. During the production life of this instrument, certain capacitors have been changed for improved component quality. When replacing these parts in old instruments, the values given in this manual should be the replacement value. The capacitors concerned are as follows:

Board A1 (Standard and Option) - C2, C3, C6, C12, C13, C14, C15, C16, C18, C19, C25, C26, C32, C33, C34, C39, C40, C41, C42, C46, C47, C48, C51, C52, C53, C54.

Board A2 - C1, C4, C5, C7, C8

CHANGE 1 (Serial number 1411G00910 and below)
On schematic 1, disconnect pin 13 of EXT switch from +14V.

CHANGE 2 (Serial number 1410G00380 and below)
in Tables 6-5 and 6-8 change the following components to:

C24	0140-0192	C-F 68pF 300 V
C35	0160-2147	C-F .025 μ F 100V
C43	0180-0159	C-F 220 μ F 10V
C50	0160-2147	C-F .025 μ F 100V
C56	0160-2214	C-F 680pF 300V
C57	0160-0134	C-F 220pF
CR12	1902-3074	DIO BKDN 4.32V
CR13	1902-3074	DIO BKDN 4.32V
CR16	1902-3003	DIO BKDN 2.37V
L2	9140-0094	CHOKE 0.68 μ H
L3	9140-0094	CHOKE 0.68 μ H
Q17	1854-0498	XSTR SI NPN
Q18	1854-0498	XSTR SI NPN
Q21	1854-0005	XSTR SI 2N708
Q22	1854-0053	XSTR SI 2N708
Q23	1853-0034	XSTR SI PNP
Q24	1853-0034	XSTR SI PNP
Q25	1853-0201	XSTR SI PNP
Q26	1854-0332	XSTR SI PNP
Q29	1854-0053	XSTR SI 2N2218
Q30	1854-0053	XSTR SI 2N2218
Q35	1854-0053	XSTR SI 2N2218R-F 180 5%

R45	0758-0014	R-F 180 5% .25W
R46	0757-0401	R-F 100 .125W
R63	0757-0397	R-F 68.1 1%
R64	0757-0397	R-F 68.1 1%
R65	0757-0284	R-F 150 1% 0.125W
R66	0757-0146	R-F 511 1% 0.125W
R67	0757-0146	R-F 511 1% 0.125W
R68	0757-0284	R-F 150 1% 0.125W
R69	0757-0346	R-F 10 1% 0.125W

R70	0757-0346
R73	0757-0346
R74	0757-0346
R75	0698-6213
R76	0698-6213
R77	0698-6213
R78	0698-6213
R79	0757-0280
R80	0757-0280
R93	0757-0280

R-F 10 1% 0.125W
R-F 10 1% 0.125W
R-F 10 1% 0.125W
R-F 37.4 1% 0.25W
R-F 37.4 1% 0.25W
R-F 37.4 1% 0.25W
R-F 37.4 1% 0.25W
R-F 1K 1% 0.125W
R-F 1K 1% 0.125W
R-F 1K 1% 0.125W

Delete the following components from Tables 6-5 and 6-8.

CR31, L7, L8, Q40, R130, R131, R132, R133, R134, R135, R136, R137, R138.

Delete CR30 from Table 6-8.

Add the following component

Add the following components to Tables 6-5 and 6-8.

MP35	1205-0033	HT SINK FOR Q35
R60	0757-0405	R-F 162 1% .125W
R91	0698-3242	R-F 357 1% .125W
R92	0757-0384	R-F 20 1% .125W

A1

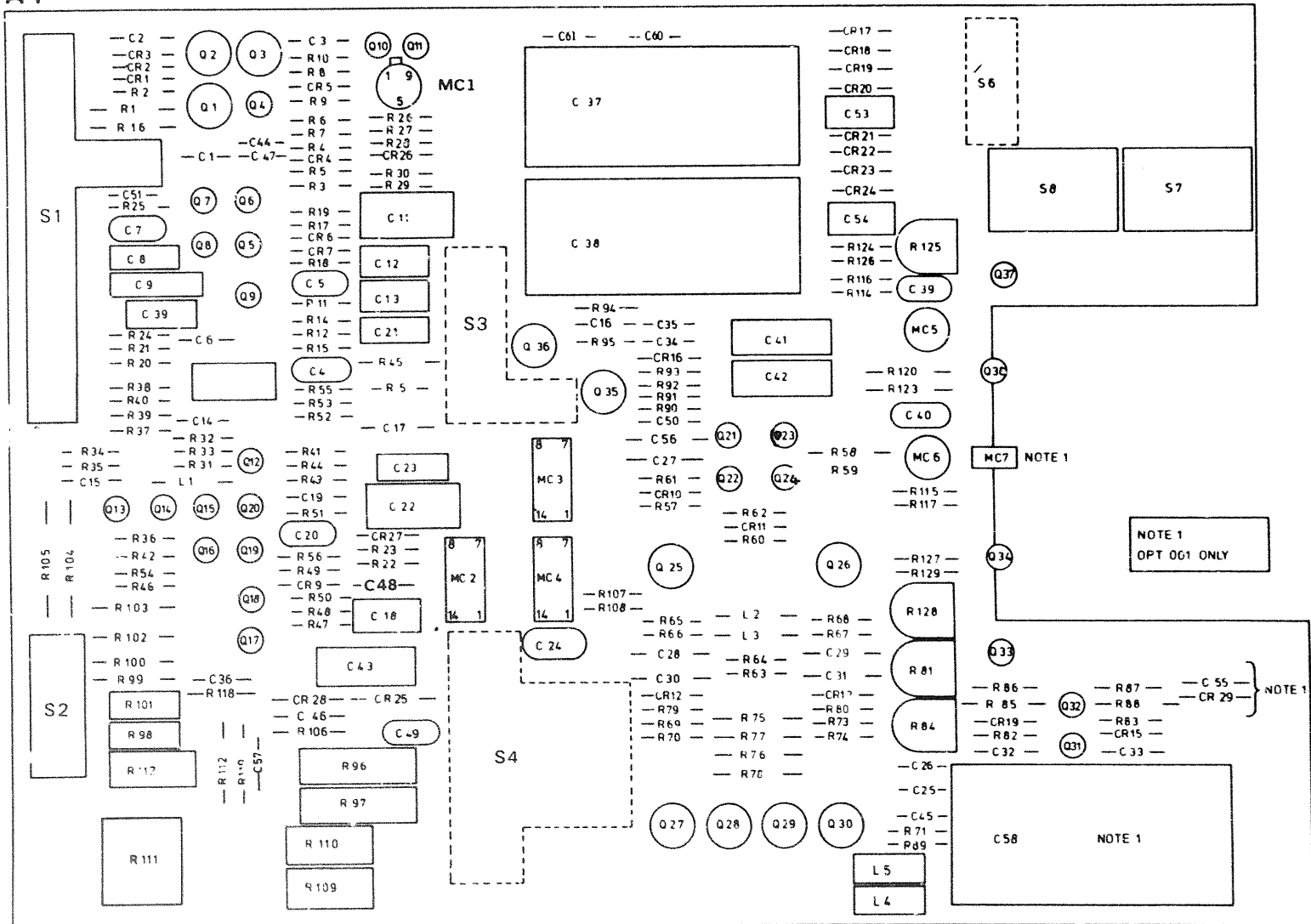

Change Schematic 2 as follows:

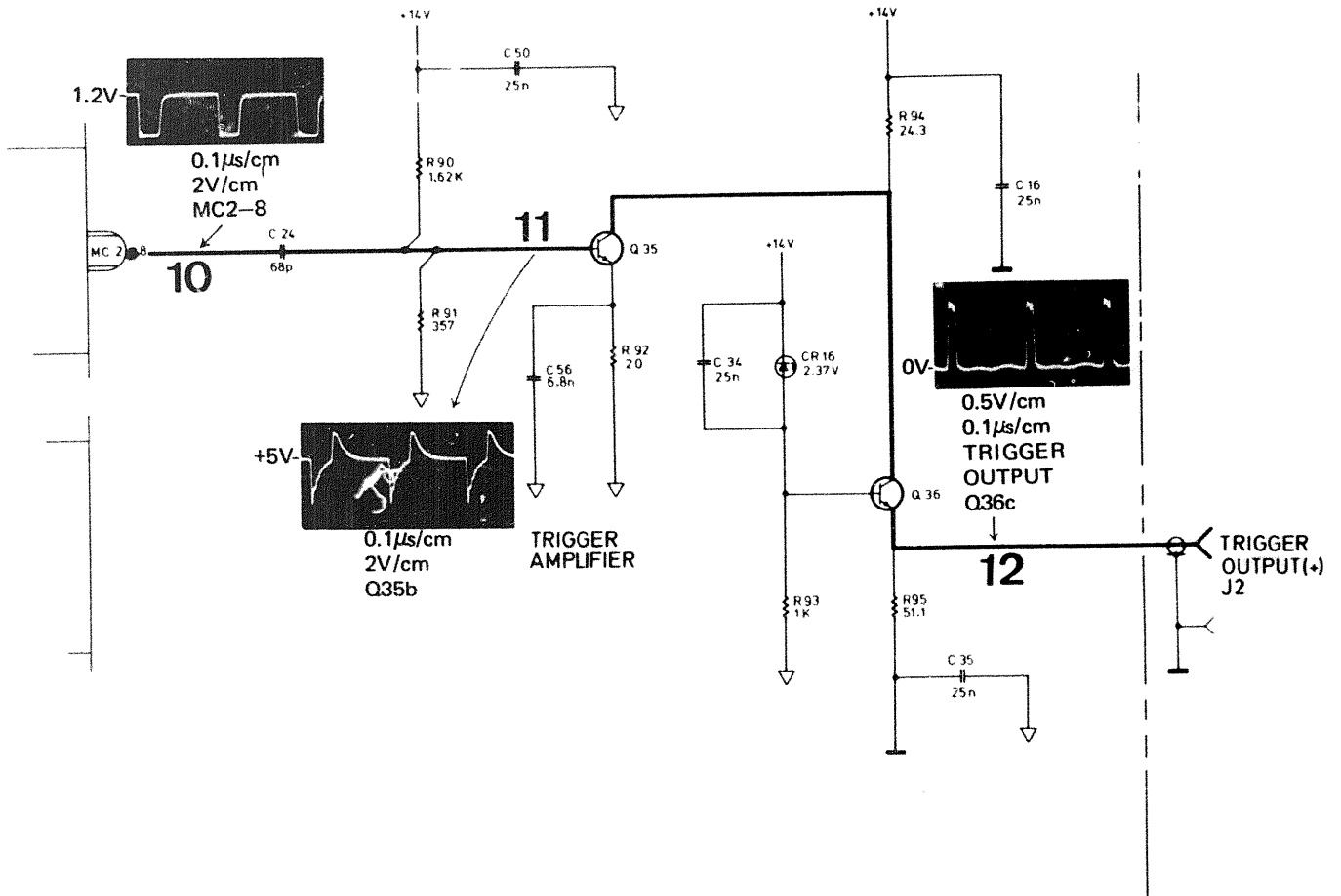

Change Schematic 3 as follows:

A1

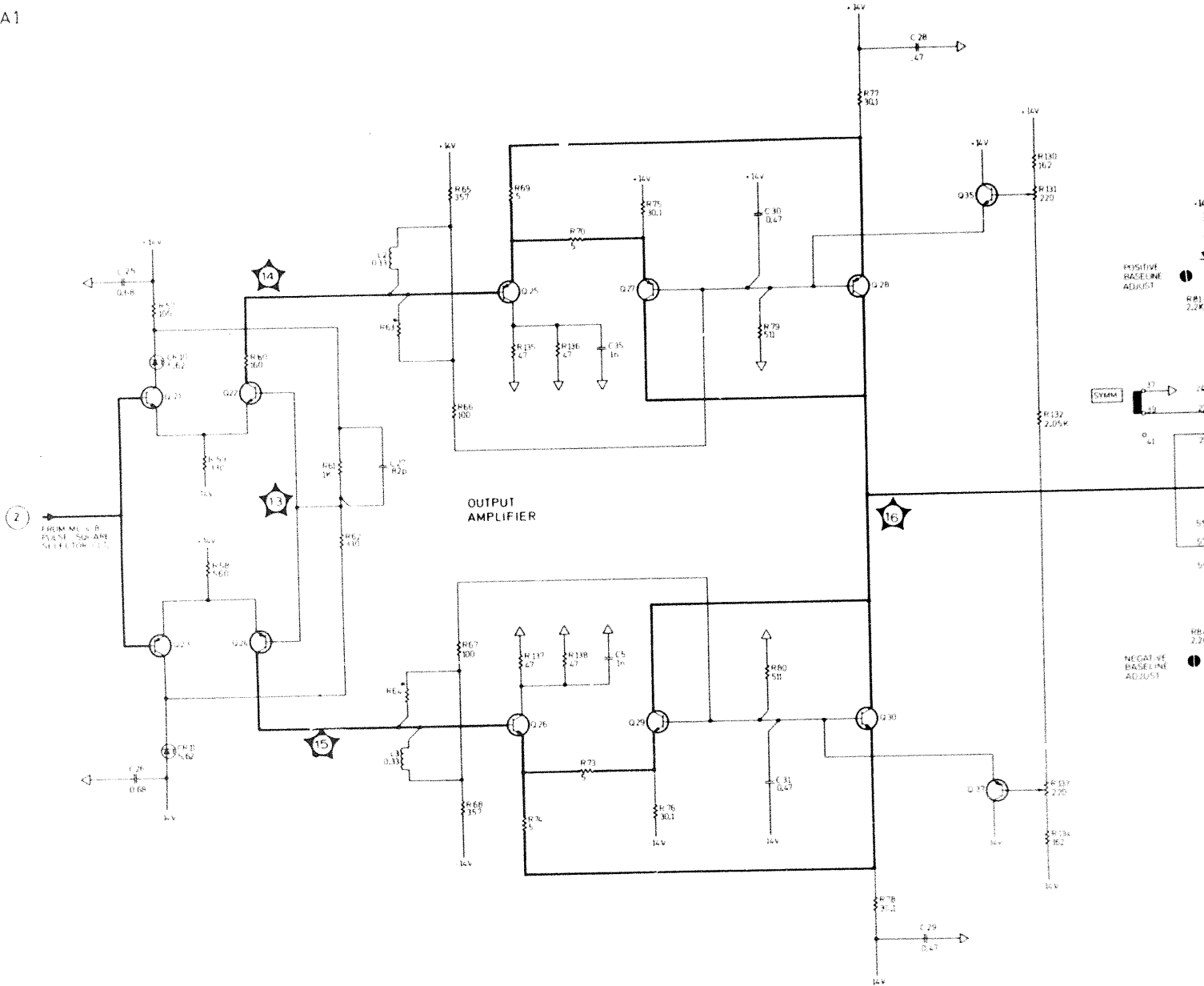

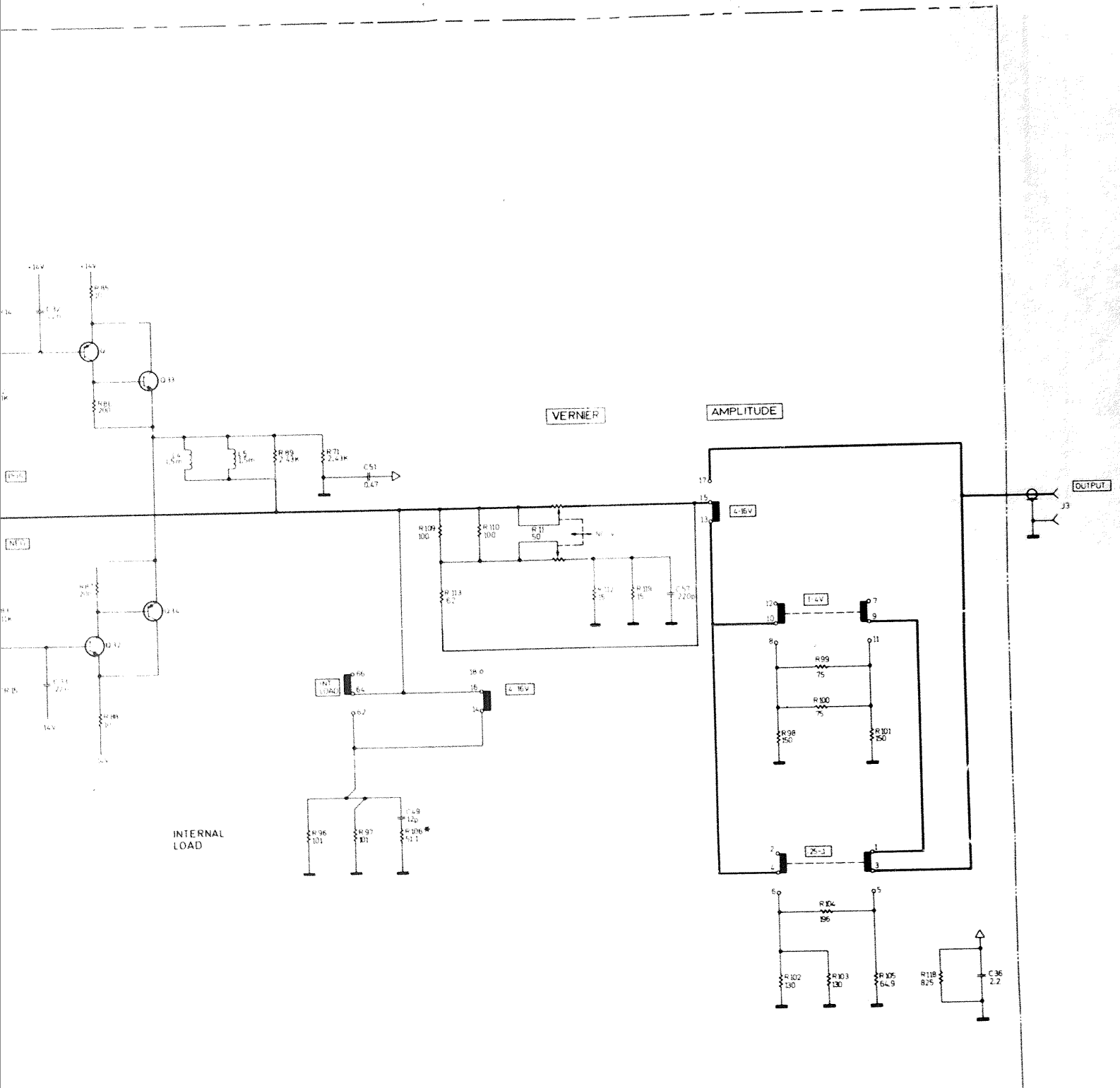

NOTE
ALL SWITCHES ARE SHOWN
IN THE "OUT" POSITION

"PUSH IN" TO SELECT MODE OR RANGE

Check the following table for your instrument serial number.

Serial Number	Manual Changes
1411 G 01286 on	1
1411 G 01311 on	1, 2
1411 G 01386 on	1-3
1411 G 01411 on	1-4

MANUAL CHANGE 1

Standard 8011A, change			
A1R4 0757-0431	R-F	2.43K	
A1R6 0757-0407	R-F	200	
8011A Option 001, change			
A4R4 0757-0431	R-F	2.43K	
A4R6 0757-0407	R-F	200	

MANUAL CHANGE 2

On Page 6-6, Assembly A1 Parts List:
 delete A1C34 0160-4210

On Page 6-4, Frame Parts List:
 change MP5 Part No. to 08011-60202

MANUAL CHANGE 3

On Page 6-18, Assembly A2 Parts List:
 change Q5, Q6 Part No. to 1853-0281

MANUAL CHANGE 4

Change parts list and schematic:
 Standard Instrument - A1 (08011-66501)

Add C 46 0160-4210 C-F 0.022 UF
 Add F 1 2110-0340 FUSE 0.4 FER

Option 001 - A1 (08011-66504)
 Delete C34 0160-4210 C-F 0.022 UF
 Add F1 2110-0340 FUSE 0.4 FER

MANUAL CHANGES

Model 8011A

Manual for Model Number	8011A
Manual printed on	Sept 1977
Manual Part Number	08011-90004

Make all ERRATA corrections.

Check the following table for your instrument serial prefix/serial number and make the listed changes to your manual.

► New Item

Serial Prefix or Serial Number	Manual Changes	Serial Prefix or Serial Number	Manual Changes
1411G01635 and below	Refer to Manual's yellow pages		
1411G01636 on	1		
1411G01661 on	2		
1411G01761 on	3		

ERRATA

Page 6-21 Change A1W1 as follows

A1W1 5081-19E8 CABLE AY RI

Delete A1X1

Manual Change 1

Pages 6-8, 6-15, 6-21, change

A1R68 0698-4421 RF 249 1%

Manual Change 2

Page 6-4 change FL 1 9100-312

FL1 9135-0035

Manual Change 3

Pages 6-9 and 6-21, Board A1 (S

change U5, U6 1826-0010

ANNUAL CHANGES

Model 8011A

Model Number	8011A
Printed on	Sept 1977
Part Number	08011-90004

Serial number

Prefix or Number	Manual Changes
------------------	----------------

ERRATA

Page 6-21 Change A1W1 as follows:

A1W1 5081-1958 CABLE AY RIBBON

Delete A1X1

Manual Change 1

Pages 6-8, 6-15, 6-21, change

A1R68 0698-4421 RF 249 1% .125W

Manual Change 2

Page 6-4 change FL 1 9100-3121 to

FL1 9135-0035

Manual Change 3

Pages 6-9 and 6-21, Board A1 (Standard and Option) Parts List:

change U5, U6 1826-0010 IC V-REG.

EUROPE, NORTH AFRICA AND MIDDLE EAST

AUSTRIA

Hewlett-Packard Ges m b H
Handelskai 52
P.O. Box 7
A-1205 Vienna
Tel: (0222) 651621 to 27
Cable: HEWPAK Vienna
Telex: 75923 hewpak a

BELGIUM

Hewlett-Packard Benelux
S.A. N.V.
Avenue de Colvert 1
(Grootkruislaan)
P.O. 1170 Brussels
Tel: (02) 672 21 40
Cable: PALOBEN Brussels
Telex: 23 494 paloben bru

CYPRUS

Kyprionics
19 Gregorios & Xenopoulos Rd
P.O. Box 1152
Cy Nicosia
Tel: 45628 29
Cable: KYPRIONICS PANDEHIS
Telex: 3018

CZECHOSLOVAKIA

Vývojová a Provozni Závadna
Výzkumných Ústavů v Bechovicích
CSSR 250997 Bechovice u Prahy
Tel: 89 93 41
Telex: 121333
Institute of Medical Biologies
Vyskumny Ústav Lekarskej Biologie
Jedlova 6
CS 86346 Bratislava-Kramare
Tel: 44 551 45-541

DDR

Entwicklungslabor der TU Dresden
Forschungsinstitut Meinsberg
DDR-7306
Waldheim/Meinsberg
Tel: 37 667
Telex: 112145
Export Contact AG Zurich
Guenther Forger
Schlegelstrasse 15
1040 Berlin
Tel: 42 74 12
Telex: 111889

DENMARK

Hewlett-Packard A/S
Datavej 52
DK-3460 Birkerød
Tel: (02) 81 66 40
Cable: HEWPAK AS
Telex: 37409 hpas dk
Hewlett-Packard A/S
Navervej 1
DK-8600 Silkeborg
Tel: (06) 82 71 86
Telex: 37409 hpas dk
Cable: HEWPAK AS

FINLAND

Hewlett-Packard Oy
Nahkahuusentie 5
P.O. Box 6
SF-00211 Helsinki 21
Tel: (90) 692303
Cable: HEWPAK JY Helsinki
Telex: 12-1563 JWPWA SF

FRANCE

Hewlett-Packard France
Quartier de Con. Tabouret
Boite Postale N° 5
F-91401 Orsay Cedex
Tel: (1) 907 78 25
Cable: HEWPAK O Orsay
Telex: 600048
Hewlett-Packard France
Agence Regionale
Le Saquin
Chemin des Mouilles
B.P. 162
F-69130 Ecullay
Tel: (78) 33 81 25
Cable: HEWPAK Ecullay
Telex: 31 06 17

Hewlett-Packard France
Agence Regionale
Périmètre de la Cèpère
Chemin de la Cèpère 20
F-31300 Toulouse-Le Mirail
Tel: (61) 40 11 12
Cable: HEWPAK 51957
Telex: 510945

Hewlett-Packard France
Agence Regionale
Aéroport principal de
Marseille Marignane
F-13721 Marignane
Tel: (91) 89 12 36
Cable: HEWPAK MARGN
Telex: 406170

Hewlett-Packard France
Agence Regionale
63 Avenue de Rochester
B.P. 1124
F-35014 Rennes Cedex
Tel: (99) 36 33 21
Cable: HEWPAK 74912
Telex: 74912

Hewlett-Packard France
Agence Regionale
74 Allée de la Robertsau
F-67000 Strasbourg
Tel: (88) 35 23 20 21
Cable: 890141
Cable: HEWPAK STRBG
Hewlett-Packard France
Agence Regionale
Centre Vauban
201 rue Colbert
Entrée 42
F-59000 Lille
Tel: (20) 51 44 14
Telex: 820744

Hewlett-Packard France
Centre d'Affaires Paris Nord
Bâtiment Ampère
Rue de La Commune de Paris
B.P. 300
F-93153 Le Blanc Mesnil Cedex
Tel: (01) 931 88 50

GERMAN FEDERAL REPUBLIC

Hewlett-Packard GmbH
Vertriebszentrale Frankfurt
Bismarckstrasse 117
Postfach 560 140
D-6000 Frankfurt 56
Tel: (0611) 50 04 1
Cable: HEWPAKSA Frankfurt
Tel: (0611) 50 04 1
Cable: HEWPAKSA Frankfurt
Telex: 04 13249 hpfmd
Hewlett-Packard GmbH
Technisches Büro Boblingen
Herrenbergerstrasse 110
D-7030 Boblingen Württemberg
Tel: (07031) 667 1
Cable: HEPAK Boblingen
Telex: 07265739 bbn

ICELAND

Medical Only
Eiding Trading Company Inc
Hafnarhvoli Tryggvafatni
B.S. Reykjavik
Tel: 1 58 20
Cable: ELDING Reykjavik

IRAN

Hewlett-Packard Iran Ltd
No. 13 Fourteenth St
Miramad Avenue
P.O. Box 412419
IR Tehran
Tel: 851082 7
Telex: 21 75 74 khm ir

IRAQ

Hewlett-Packard Trading Co
418 Mansour City
Baghdad
Tel: 5517827
Telex: 2455 heparaq
Cable: HEWPAQDAD
Baghdad Iraq

IRELAND

Hewlett-Packard Ltd
King Street Lane
GB Warriner, Wokingham
Berks. RG11 5AR
Tel: (0734) 78 47 74
Telex: 847178 848179

HUNGARY

Hewlett-Packard GmbH
Werk Grootzingen
Olmstrasse 6
D-7500 Karlsruhe 41
Tel: (0721) 69 40 06
Telex: 07 825707

Hewlett-Packard GmbH
Technisches Büro Nürnberg
Neumeyer Str. 9
D-8500 Nuremberg
Tel: (0911) 56 30 83 85
Telex: 0623 866

Hewlett-Packard GmbH
Technisches Büro München
Unterhachinger Strasse 28
ISAR Center
D-8012 Ottobrunn
Tel: (089) 90 61 7
Cable: HEWPAKSA München
Telex: 0524985

Hewlett-Packard GmbH
Technisches Büro Berlin
Keith Strasse 2 4
D-1000 Berlin 30
Tel: (030) 24 90 86
Telex: 18 3405 hptm d

GREECE

Kostas Karayannis
08 Omirou Street
GR Athens 133
Tel: 323731
Cable: RAKAR Athens
Telex: 21 59 62 rkar gr

Medical Only

INTECO G. Papathanassiou & Co
Marni 17
GR Athens 103
Tel: 522 1915
Cable: INTEKNIKA Athens
Telex: 21 5329 INTE GR

Medical Only

Technomed Hellas Ltd
52 Skoufa Street
GR Athens 135
Tel: 362 6972 363 3630
Cable: ETALAK Athens
Telex: 21-4693 ETAL GR

MOROCCO

Muszugry és Mérestechnika
Szélgátalja
Lenin Krt. 67
1391 Budapest VI
Tel: 42 03 38
Telex: 22 51 14

NETHERLANDS

Hewlett-Packard Benelux N.V.
Van Heuven Goedhartlaan 121
P.O. Box 667
NL-1134 Amstelveen
Tel: (020) 47 20 21
Cable: PALOBEN Brussels
Telex: 23 494

NETHERLANDS

Hewlett-Packard Benelux N.V.
Van Heuven Goedhartlaan 121
P.O. Box 667
NL-1134 Amstelveen
Tel: (020) 47 20 21
Cable: PALOBEN Brussels
Telex: 23 494

NORWAY

Hewlett-Packard Norge A/S
Nesveien 13
Box 149
N-1344 Haeslum
Tel: (02) 53 83 60
Telex: 16621 hpnas n

NETHERLANDS

Hewlett-Packard Benelux N.V.
Van Heuven Goedhartlaan 121
P.O. Box 667
NL-1134 Amstelveen
Tel: (020) 47 20 21
Cable: PALOBEN Brussels
Telex: 23 494

NETHERLANDS

Hewlett-Packard Benelux N.V.
Van Heuven Goedhartlaan 121
P.O. Box 667
NL-1134 Amstelveen
Tel: (020) 47 20 21
Cable: PALOBEN Brussels
Telex: 23 494

NETHERLANDS

Hewlett-Packard Benelux N.V.
Van Heuven Goedhartlaan 121
P.O. Box 667
NL-1134 Amstelveen
Tel: (020) 47 20 21
Cable: PALOBEN Brussels
Telex: 23 494

NETHERLANDS

Hewlett-Packard Benelux N.V.
Van Heuven Goedhartlaan 121
P.O. Box 667
NL-1134 Amstelveen
Tel: (020) 47 20 21
Cable: PALOBEN Brussels
Telex: 23 494

NETHERLANDS

Hewlett-Packard Benelux N.V.
Van Heuven Goedhartlaan 121
P.O. Box 667
NL-1134 Amstelveen
Tel: (020) 47 20 21
Cable: PALOBEN Brussels
Telex: 23 494

ITALY

Hewlett-Packard Italiana S.p.A.
Via Amerigo Vespucci 2
Casella postale 3645
I-20190 Milano
Tel: (2) 6251 110 lines
Cable: HEWPAKIT Milano
Telex: 32046

Hewlett-Packard Italiana S.p.A.
Via Pietro Maroncelli 40
Iang Via Visentini
I-35100 Padova
Tel: (49) 66 48 88
Telex: 41612 Hewpacki

Medical Only

Hewlett-Packard Italiana S.p.A.
Via d'Agliardi 7
I-56100 Pisa
Tel: (050) 2 32 04
Telex: 32046 via Milano

Medical Only

Hewlett-Packard Italiana S.p.A.
Via G. Armetino 10
I-00143 Roma
Tel: (06) 54 69 61
Telex: 61514
Cable: HEWPAKIT Roma

Medical Only

Hewlett-Packard Italiana S.p.A.
Corso Giovanni Lanza
I-1031 Torino
Tel: (011) 68 245 659308
Medical Calculators Only
Hewlett-Packard Italiana S.p.A.
Via Principe Nicola 43 C/C
I-95126 Catania
Tel: (095) 37 05 04

Medical Only

Hewlett-Packard Italiana S.p.A.
Via Amerigo Vespucci 9
I-80142 Napoli
Tel: (081) 33 27 11
Hewlett-Packard Italiana S.p.A.
Via E. Masi 9/B
I-40137 Bologna
Tel: (051) 30 76 87

KUWAIT

Al-Khalidya Trading &
Contracting Co.
P.O. Box 830-Salt
Kuwait
Tel: 424910-411726
Telex: 2481 areep kt
Cable: VISDCUNT

LUXEMBURG

Hewlett-Packard Benelux
S.A. N.V.
Avenue de Colvert 1
(Grootkruislaan)
P.O. 1170 Brussels
Tel: (02) 672 22 40
Cable: PALOBEN Brussels
Telex: 23 494

MOROCCO

Gerep
190 Blvd. Brahim Roudani
Casablanca
Tel: 25-16-76-25-90-99
Cable: Gerep-Gasa
Telex: 23739

NETHERLANDS

Hewlett-Packard Benelux N.V.
Van Heuven Goedhartlaan 121
P.O. Box 667
NL-1134 Amstelveen
Tel: (020) 47 20 21
Cable: PALOBEN Amsterdam
Telex: 13 216 hepa ni

NORWAY

Hewlett-Packard Norge A/S
Nesveien 13
Box 149
N-1344 Haeslum
Tel: (02) 53 83 60
Telex: 16621 hpnas n

NETHERLANDS

Hewlett-Packard Benelux N.V.
Van Heuven Goedhartlaan 121
P.O. Box 667
NL-1134 Amstelveen
Tel: (020) 47 20 21
Cable: PALOBEN Brussels
Telex: 23 494

NETHERLANDS

Hewlett-Packard Benelux N.V.
Van Heuven Goedhartlaan 121
P.O. Box 667
NL-1134 Amstelveen
Tel: (020) 47 20 21
Cable: PALOBEN Brussels
Telex: 23 494

NETHERLANDS

Hewlett-Packard Benelux N.V.
Van Heuven Goedhartlaan 121
P.O. Box 667
NL-1134 Amstelveen
Tel: (020) 47 20 21
Cable: PALOBEN Brussels
Telex: 23 494

NETHERLANDS

Hewlett-Packard Benelux N.V.
Van Heuven Goedhartlaan 121
P.O. Box 667
NL-1134 Amstelveen
Tel: (020) 47 20 21
Cable: PALOBEN Brussels
Telex: 23 494

NETHERLANDS

Hewlett-Packard Benelux N.V.
Van Heuven Goedhartlaan 121
P.O. Box 667
NL-1134 Amstelveen
Tel: (020) 47 20 21
Cable: PALOBEN Brussels
Telex: 23 494

POLAND

Biuro Informacji Technicznej
Hewlett-Packard
ul. Stawki 2 6P
00-950 Warszawa
Tel: 395962 395187
Telex: 81 24 53 hepa pl

UNIPAN

Zaklad Orowadaczony
Budowlany Aparatury Naukowej
ul. Krakowscy Rody Narodowej 51 55
00 800 Warszawa
Tel: 36190
Telex: 81 46 48
Zaklady Naprawcze Sprzetu
Medycznego
Plac Komuny Paryskiej 6
00 007 Warszawa
Tel: 3 337 83

PORTUGAL

Telectra Empresa Technica de
Equipamentos Electronicos S a r l
Rua Rodrigo da Fonseca 103
P.O. Box 2531
P. Lisbon 1
Tel: (1) 68 60 72
Cable: TELECTRA Lisboa
Telex: 12598

Medical Only

Mundinter
Intercomba Mundial de Comercio
S a r l
Av. A de Aguiar 138
P.O. Box 2761
P. Lisbon 1
Tel: (1) 53 21 31 7
Cable: INTERCAMBIO Lisbon

RUMANIA

Hewlett-Packard Reprezentanta
Bucuresti
Bd. N. Bălcescu 16
P.O. Box 1228
Bucharest
Tel: (0602) 138885
Telex: 10440

TURKEY

Telekom Engineering Bureau
P.O. Box 437
Beyoğlu
TR Istanbul
Tel: 49 40 40
Cable: TELEMATIION Istanbul
Telex: 23609

Medical Only

E M A
Mühendislik Kolektif Şirketi
Adakale Sokak 41-6
TR Ankara
Tel: 175622
Analytical only
Yilmaz Özyürek
Mim. Mudafaa Cad. No: 16/6
Kızılay
TR Ankara
Tel: 25 03 09
Telex: 42576 özek tr

UNITED KINGDOM

Hewlett-Packard Ltd
King Street Lane
GB Warriner, Wokingham
Berks. RG11 5AR
Tel: (0734) 78 47 74
Cable: Hewple London
Telex: 847178 9

Medical Only

Hewlett-Packard Ltd
Trafalgar House
Navigation Road
Chesham
Aldershot
Hants. GU14 1NU
Tel: (061) 929 6422
Telex: 66068

Hewlett-Packard Ltd

Lygon Court
Hewarley Road
Dudley Rise
Halesowen
West Midlands B62 8SD
Tel: (021) 550 9911
Telex: 339105

NETHERLANDS

Hewlett-Packard Benelux N.V.
Van Heuven Goedhartlaan 121
P.O. Box 667
NL-1134 Amstelveen
Tel: (020) 47 20 21
Cable: PALOBEN Brussels
Telex: 23 494

NETHERLANDS

Hewlett-Packard Benelux N.V.
Van Heuven Goedhartlaan 121
P.O. Box 667
NL-1134 Amstelveen
Tel: (020) 47 20 21
Cable: PALOBEN Brussels
Telex: 23 494

NETHERLANDS

Hewlett-Packard Benelux N.V.
Van Heuven Goedhartlaan 121
P.O. Box 667
NL-1134 Amstelveen
Tel: (020) 47 20 21
Cable: PALOBEN Brussels
Telex: 23 494

NETHERLANDS

Hewlett-Packard Benelux N.V.
Van Heuven Goedhartlaan 121
P.O. Box 667
NL-1134 Amstelveen
Tel: (020) 47 20 21
Cable: PALOBEN Brussels
Telex: 23 494

NETHERLANDS

Hewlett-Packard Benelux N.V.
Van Heuven Goedhartlaan 121
P.O. Box 667
NL-1134 Amstelveen
Tel: (020) 47 20 21
Cable: PALOBEN Brussels
Telex: 23 494

NETHERLANDS

Hewlett-Packard Benelux N.V.
Van Heuven Goedhartlaan 121
P.O. Box 667
NL-1134 Amstelveen
Tel: (020) 47 20 21
Cable: PALOBEN Brussels
Telex: 23 494

NETHERLANDS

Hewlett-Packard Benelux N.V.
Van Heuven Goedhartlaan 121
P.O. Box 667
NL-1134 Amstelveen
Tel: (020) 47 20 21
Cable: PALOBEN Brussels
Telex: 23 494

SWEDEN

Hewlett-Packard Sverige AB
Engelstsvägen 1-3
Fack
S-161 20 Bromma 20
Tel: (08) 730 05 30
Cable: MEASUREMENTS
Stockholm
Telex: 10721

Medical Only

Hewlett-Packard Sverige AB
Ostra Vintergatan 22
S-702 40 Örebro
Tel: (019) 14 07 20
Hewlett-Packard Sverige AB
Fritällargatan 30
S-211 32 Västra Frölunda
Tel: (031) 49 09 50
Telex: 10721 Via Bromma Office

SWITZERLAND

Hewlett-Packard (Schweiz) AG
Zürcherstrasse 20
P.O. Box 307
CH-8952 Schlieren-Zürich
Tel: (01) 730 52 40 730 18 21
Cable: HPAG C I
Telex: 53933 hpag ch

Medical Only

Hewlett-Packard (Schweiz) AG
Château Blanc 19
CH-1219 Le Lignon-Geneva
Tel: (022) 96 03 22
Cable: HEWPAKAG Geneva
Telex: 27 333 hpag ch

Medical Only

Hewlett-Packard (Schweiz) AG
Château Blanc 19
CH-1219 Le Lignon-Geneva
Tel: (022) 96 03 22
Cable: HEWPAKAG Geneva
Telex: 27 333 hpag ch

Medical Only

Hewlett-Packard (Schweiz) AG
Château Blanc 19
CH-1219 Le Lignon-Geneva
Tel: (022) 96 03 22
Cable: HEWPAKAG Geneva
Telex: 27 333 hpag ch

Medical Only

Hewlett-Packard (Schweiz) AG
Château Blanc 19
CH-1219 Le Lignon-Geneva
Tel: (022) 96 03 22
Cable: HEWPAKAG Geneva
Telex: 27 333 hpag ch

Medical Only

Hewlett-Packard (Schweiz) AG
Château Blanc 19
CH-1219 Le Lignon-Geneva
Tel: (022) 96 03 22
Cable: HEWPAKAG Geneva
Telex: 27 333 hpag ch

Medical Only

Hewlett-Packard (Schweiz) AG
Château Blanc 19
CH-1219 Le Lignon-Geneva
Tel: (022) 96 03 22
Cable: HEWPAKAG Geneva
Telex: 27 333 hpag ch

Medical Only

Hewlett-Packard (Schweiz) AG
Château Blanc 19
CH-1219 Le Lignon-Geneva
Tel: (022) 96 03 22
Cable: HEWPAKAG Geneva
Telex: 27 333 hpag ch

Medical Only

Hewlett-Packard (Schweiz)