

Bipolar Junction Transistors

Murray Thompson

Sept. 5, 1999

Contents

1	Introduction	1
2	A Reassurance	1
3	Summary of Bipolar Transistor “theory” so far	2
4	Transistor Model	5
5	Various Simple Amplifiers	6
6	A Useful form of the Common Emitter Amplifier	20
7	A More Useful Form of the Common Emitter Amplifier	21

—

1 Introduction

These notes follow those on pn junctions, in which the basic components of npn transistors were discussed.

2 A Reassurance

At this point, some students, who prefer to have precise calculations and exact theory, may start to become concerned about these sloppy methods,

bad approximations and imprecise calculations. We can reassure them. In spite of these rough methods, the general concept of negative feedback (to be introduced later) will allow us to use these imperfect circuits yet gain extremely linear circuits, extremely precise amplifications and precision measurements of our input signals.

First we must consider these imperfect amplifiers. The later feedback and precision circuits would be useless without them!

3 Summary of Bipolar Transistor “theory” so far

1. The fraction of the electrons leaving the emitter and going to the collector instead of the base is normally called $\frac{I_{collector}}{I_{emitter}} = \alpha$.

More strictly, in case of non-linear behaviour, we define

$$\alpha = \frac{dI_{collector}}{dI_{emitter}}$$

2. The ratio of the collector current to the base current is normally called β . Thus, $\beta = \frac{I_{collector}}{I_{base}}$ From this we can get

$$\beta = \frac{\alpha}{1-\alpha}.$$

More strictly, in case of non-linear behaviour, we define

$$\alpha = \frac{dI_{collector}}{dI_{emitter}}$$

3. Hence $(1 - \alpha)\beta = \alpha$

$$\alpha = \frac{\beta}{1+\beta}$$

4. By arranging the geometry so that the base region is very thin, most of the electrons entering from the emitter into the base will be fall over the edge down the steep electric potential fall of the base-collector junction before they meet and recombine with holes in the base.

Thus, by making the base be very thin so that the emitter-base junction and the collector-base junction are very close, and doping the collector-base junction so that it is very thin (with a high electric field $\vec{E} = -\frac{dV}{dx}$, the fraction α of the electrons leaving the emitter and going to the

collector instead of the base can be made close to 1.0 and $\beta = \frac{\alpha}{1-\alpha}$ can be made large. This can make the transistor more useful.

While a transistor with a large β , such as $\beta = 100$, can be used to make amplifiers with a high gain, the thin base and collector-base junction have a general defect. This defect is that the thin collector-base junction will have high electric fields \vec{E} and avalanche breakdown may occur.

5. So long as the collector-base voltage is greater than about 2 or 3 volts, very few of the electrons which fall over the collector-base junction can bounce back.

Thus, So long as the collector-base voltage is greater than about 2 or 3 volts, the fraction α of electrons passing through both junctions is only slightly dependent upon the collector-base voltage.

A typical set of $I_{collector}$ and $V_{Collector-Emmitter}$ curves for equispaced base currents are shown below.

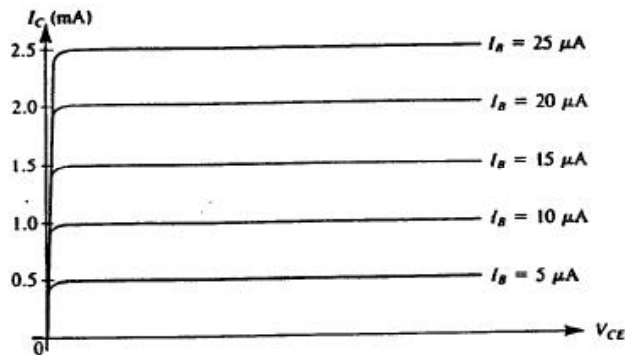

Although the following curves are not usually shown in specifications, the following shows $I_{Collector}$ and I_{Base} curves for equispaced collector voltages.

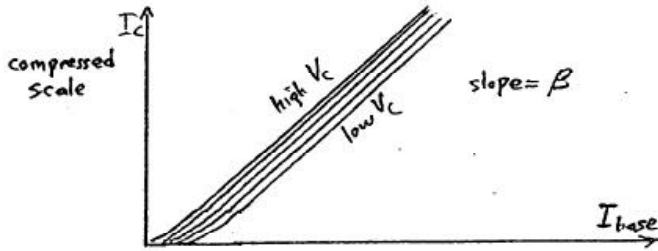

6. Thus α and particularly β are useful parameters because they are nearly constant for any given bipolar junction transistor over a range of working voltages and currents.

The β may vary from one transistor to another due to manufacturing variations and due to changing temperature. Note that I_C in the following graph has a logarithmic horizontal scale and covers a very wide range.

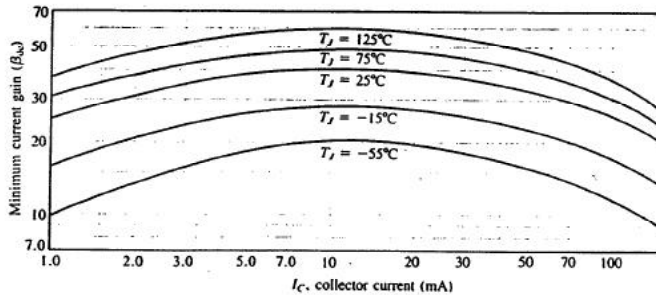

Even though β does not change much with voltage and current, in any given transistor, the variation in β due to temperature and manufacturing is significant. The variation due to manufacturing, can be minimized by selecting transistors with particular values of β .

7. In most practical circuits, we try to make the action be independent of β .

This can be done in a variety of ways but will require that β be large so that $\beta \gg 1$ and we can approximate functions like $\beta + 1$ as β .

8. The transistor is said to be in saturation if the collector voltage is too low.

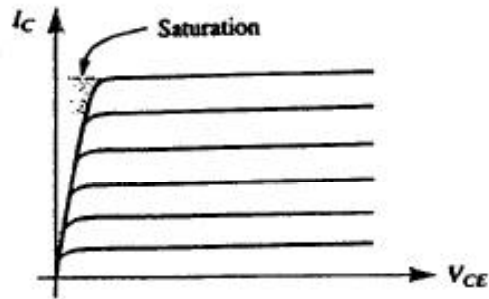

9. Any transistor has maximum ratings for

- (a) The maximum power giving a maximum product of $I_{C \max}$ and $V_{CE \max}$.
- (b) A maximum current into the collector $I_{C \max}$ through its connecting wire and weld.
- (c) A maximum voltage on the collector-base junction $V_{CE \max}$ above which the junction may break down.

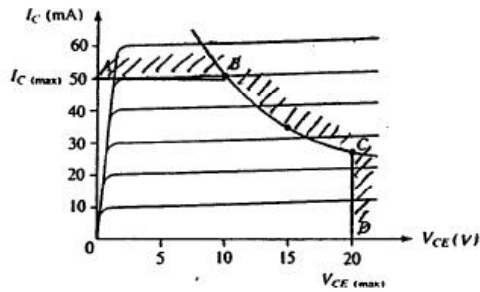

4 Transistor Model

By inspecting the transistor $I_{Collector}$, V_{CE} and β curves above, we can make a model of the actions within a transistor. Like some other models, the reproduction is imperfect but will allow us to make systems where the action is nearly independent of β .

We want a 3-terminal model which we can use to “replace the transistor” when want to make calculations. In this model we assume

1. The base-emitter junction is kept forward biased (“turned on”) by a small but sufficient base-emitter current to keep the base emitter voltage near 0.7 volt.
2. The Base-Collector voltage is sufficient for the transistor to have a $\beta > 10$

A common convention is to use lower case r for each of the internal resistances to distinguish them from the normal external resistors we attach to the emitter, base and collector.

We will call the join of the 3 lines as the point “join”.

We replace the base to emitter junction with a small 0.7 volt battery with a small (perhaps negligible resistor r_b).

The current through the base is called I_b .

From the previous discussion of p,n junctions, we know that the emitter has the dynamic junction impedance (which may also be negligible) of about $r_e = 2 \text{ ohm} + \frac{0.026 \text{ volt}}{I_{base}}$.

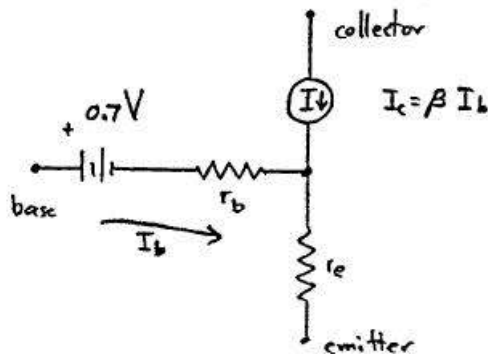

We insert a “Current Generator” in the collector to cause a current $I_C = \beta I_b$.

5 Various Simple Amplifiers

We will now consider four general circuits corresponding to the 3 permutations of 1 terminal being “shared” between the circuitry of the input and output attached circuitry – the permutation of the common emitter is used twice. Each amplifier amplifies an input DC voltage which may change. By using an additional “coupling capacitor”, each can amplify only the AC component of the input voltage.

1. Grounded Emitter Amplifier

The simple transistor model suggests how an amplifier might be made. We call this a grounded emitter amplifier.

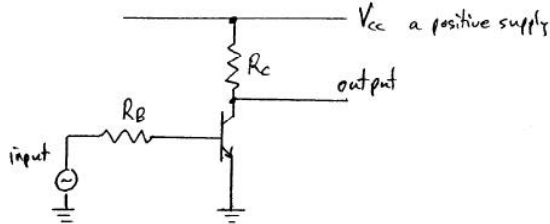

Variations ΔV_{input} in the base input voltage will cause variations in the emitter current through r_b . The transistor can be replaced for calculation purposes by the transistor model as in the next diagram. If, as usual, r_e is small, then

$$\Delta I_b = \frac{\Delta V_{input}}{R_B + r_b}$$

and these will cause variations in the collector current

$$\Delta I_c = \beta \Delta I_b = \beta \frac{\Delta V_{input}}{R_B + r_b}$$

The changing collector current flows through the collector resistor R_C from a constant voltage usually called “ V_{cc} ” and so the changing collector current causes the collector voltage to change by

$$\Delta V_C = - R_C \beta \frac{\Delta V_{input}}{R_B + r_b}$$

$$\Delta V_C = - \left(\frac{R_C \beta}{R_B + r_b} \right) \cdot \Delta V_{input}$$

Thus a small change in the input to the base can cause a larger change in the voltage of the collector.

- The “voltage gain” or “amplification” $\frac{V_c}{V_b} = - \left(\frac{R_C \beta}{R_B + r_b} \right)$ is negative meaning that the output signal is inverted relative to the input signal. This is not an disadvantage but is actually an advantage for negative feedback and for digital circuitry.
- This circuit is very easy to understand but is seldom used for the following reasons.
- It is hard to make transistors with a particular precise value of β .
- In any transistor, β depends upon temperature

- (e) β also depends, slightly, upon the collector voltage and collector current I_c . (In other words, the transistor model is not very precise.)
- (f) r_b depends, a little, upon temperature, I_b and I_c .
- (g) r_e depends, a little, upon temperature, I_b and I_c .
- (h) The voltage difference across the junction (near 0.7 volt) is temperature dependent.

In general, the grounded emitter gives a high amplification but the voltage gain $\frac{V_c}{V_b}$ is too unpredictable for this circuit to be used except in digital circuits.

The following three amplifying circuits include some type of “negative feedback” to overcome these problems. Other circuits use transistors in identical pairs and use them to amplify pairs of voltages (one the signal and the other a constant voltage or a negative signal) so that some of the unwanted effects can cancel.

2. Common Emitter Amplifier

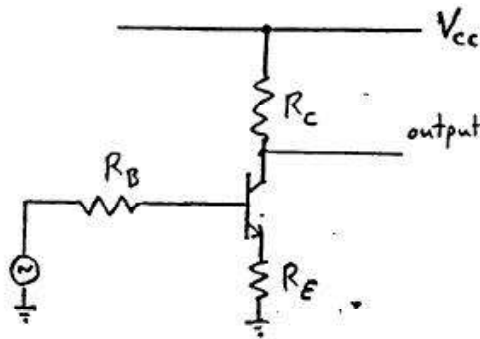

This has 3 resistors as shown R_B , R_E and R_C attached to the base, emitter and collector. The top “rail” is attached to a positive power supply (perhaps +10 Volt). The lower “rail” is the ground.

The input is on the left (via the resistor R_B). The output is on the right from the collector pin attached to the resistor R_C .

Apply a small incremental voltage ΔV_{in} to the resistor R_B leading to the base.

The transistor can be replaced for calculation purposes by the transistor model as in the next diagram.

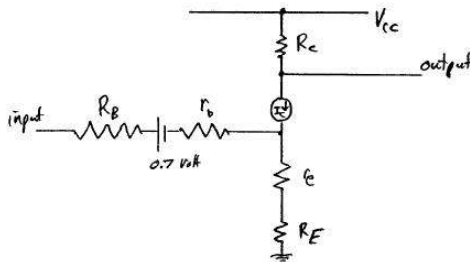

We concern ourselves only with the current and voltage increments so can ignore the +0.7 volt battery. Define the voltage on the point below the current generator at the join of the 3 lines as ΔV_{join} . We can obtain 2 equations.

- (a) The current increment ΔI_{Base} into the base due to the voltage increment ΔV_{in} is

$$\Delta I_{Base} = \frac{\Delta V_{in} - \Delta V_{join}}{R_B + r_b}$$

- (b) The current increment $\Delta I_{Collector}$ into the Collector due to the voltage increment ΔV_{in} is

$$\Delta I_{Collector} = \beta \Delta I_{Base}$$

The voltage increment across the actual resistor R_E and the internal resistance r_e totalling $R_E + r_e$, due to the two currents caused by the voltage increment ΔV_{in} is

$$\Delta V_{join} = (1 + \beta) \Delta I_{Base} (R_E + r_e)$$

From these two equations

$$\Delta I_{Base} = \frac{\Delta V_{in} - (1 + \beta) \Delta I_{Base} (R_E + r_e)}{R_B + r_b}$$

$$(R_B + r_b) \Delta I_{Base} = \Delta V_{in} - (1 + \beta) \Delta I_{Base} (R_E + r_e)$$

$$(R_B + r_b) \Delta I_{Base} + (1 + \beta) \Delta I_{Base} (R_E + r_e) = \Delta V_{in}$$

$$(R_B + r_b + (1 + \beta)(R_E + r_e)) \Delta I_{Base} = \Delta V_{in}$$

$$\Delta I_{Base} = \frac{\Delta V_{in}}{(R_B + r_b + (1 + \beta)(R_E + r_e))}$$

From this, we can calculate 3 important parameters for this circuit.

- (a) The Voltage Gain of the common emitter circuit

The collector voltage will decrement due to the increased current through the resistor R_C from the positive +10 Volt supply. Thus the voltage increment on the collector will be negative;

$$\Delta V_C = -\Delta I_C R_C$$

$$\Delta V_C = -\beta \Delta I_{Base} R_C$$

$$\Delta V_C = -\beta \frac{\Delta V_{in}}{(R_B + r_b + (1 + \beta)(R_E + r_e))} R_C$$

Thus the voltage gain of this common emitter circuit is

$$A_V = \frac{\Delta V_C}{\Delta V_{in}} = -\frac{\beta R_C}{(R_B + r_b + (1 + \beta)(R_E + r_e))}$$

If we neglect both r_b and r_e , then

$$A_V \approx -\frac{\beta(R_C)}{(R_C + (1 + \beta)R_E)}$$

again, if we assume that $\beta \gg 1$, the voltage gain, A_V , becomes

$$A_V \approx -\frac{R_C}{R_E}$$

Notes.

- The gain is negative meaning that the output voltage signal is inverted.

- Using the concepts of feedback, we say that the resistor R_E is providing negative feedback so that in the approximations of β being high and r_b and r_e being low, the voltage gain A_V is minus(the ratio of the collector and emitter resistances)

(b) The Input Impedance of the common emitter circuit

The Input Impedance is the ratio

$$Z_{in} = \frac{\Delta V_{in}}{\Delta I_{Base}}$$

Use ΔI_{Base} from above

$$Z_{in} = (R_B + r_b + (1 + \beta)(R_E + r_e))$$

Again, if we neglect r_b and r_e and assume that $\beta \gg \frac{R_B}{R_E}$ then

$$Z_{in} = \beta R_E$$

(c) The Output Impedance of the common emitter circuit

Remembering that the impedance of a current generator is infinite, the output impedance of the circuit looking back into the circuit is only that of the resistor R_C to the power supply which is a virtual ground. Thus we have

$$Z_{out} = R_C$$

3. Common Collector Amplifier (The “Emitter Follower”)

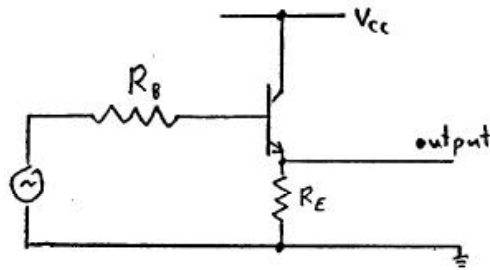

This has 2 resistors as shown R_B and R_E attached to the base and emitter. The top “rail” is attached to a positive power supply (perhaps +10 Volt). The lower “rail” is the ground.

The Collector is attached directly to the top rail at +10 Volt.

The input is on the left (via the resistor R_B . The output is on the right from the emitter pin attached to the resistor R_E .

Apply a small incremental voltage v_{in} to the resistor R_B leading to the base.

The transistor can be replaced for calculation purposes by the transistor model.

Apply a small incremental voltage ΔV_{in} to the resistor R_B leading to the base.

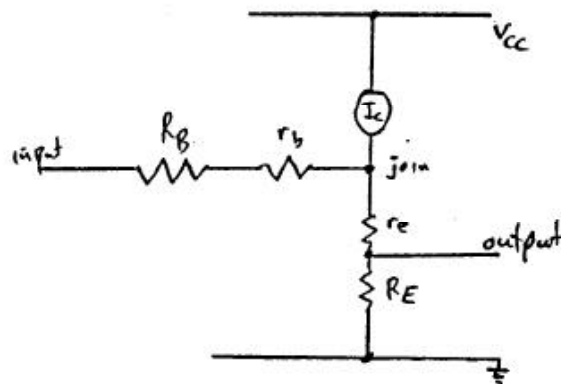

We concern ourselves only with the current and voltage increments so can ignore the +0.7 volt battery. Define the voltage on the point below the current generator at the join of the 3 lines as ΔV_{join}

As with the Common Emitter before, we can obtain 2 equations.

- (a) The current increment ΔI_{Base} into the base due to the voltage increment ΔV_{in} is

$$\Delta I_{Base} = \frac{\Delta V_{in} - \Delta V_{join}}{R_B + r_b}$$

- (b) The current increment $\Delta I_{Collector}$ into the Collector due to the voltage increment ΔV_{in} is

$$\Delta I_{Collector} = \beta \Delta I_{Base}$$

The voltage increment across the actual resistor R_E and the internal resistance r_e totalling $R_E + r_e$, due to the two currents caused by the voltage increment ΔV_{in} is

$$\Delta V_{join} = (1 + \beta) \Delta I_{Base} (R_E + r_e)$$

From these two equations

$$\Delta I_{Base} = \frac{\Delta V_{in} - (1 + \beta) \Delta I_{Base} R_E}{R_B + r_b}$$

$$(R_B + r_b) \Delta I_{Base} = \Delta V_{in} - (1 + \beta) \Delta I_{Base} (R_E + r_e)$$

$$(R_B + r_b) \Delta I_{Base} + (1 + \beta) \Delta I_{Base} (R_E + r_e) = \Delta V_{in}$$

$$(R_B + r_b + (1 + \beta)(R_E + r_e)) \Delta I_{Base} = \Delta V_{in}$$

$$\Delta I_{Base} = \frac{\Delta V_{in}}{(R_B + r_b + (1 + \beta)(R_E + r_e))}$$

From this, we can calculate 3 important parameters for this circuit.

- (a) The Voltage Gain of the common collector (emitter follower) circuit

The current through the emitter is

$$\Delta I_{Emitter} = (1 + \beta) \Delta I_{Base}$$

The voltage increment across R_E is the output signal ΔV_{out}

$$\Delta V_{out} = \Delta I_{Emitter} R_E$$

$$\Delta V_{out} = (1 + \beta) \frac{\Delta V_{in}}{(R_B + r_b + (1 + \beta)(R_E + r_e))} R_E$$

$$\Delta V_{out} = \frac{(1 + \beta) R_E}{(R_B + r_b + (1 + \beta)(R_E + r_e))} \Delta V_{in}$$

If we neglect r_e and r_b

$$\Delta V_{out} \approx \frac{(1+\beta)R_E}{(R_B+(1+\beta)R_E)} \Delta V_{in}$$

If $\beta \gg 1$, then

$$\Delta V_{out} \approx \frac{(1+\beta)R_E}{(R_B+(1+\beta)R_E)} \Delta V_{in}$$

The voltage Gain

$$A_V = \frac{\Delta V_{out}}{\Delta V_{in}} \approx \frac{(1+\beta)R_E}{(R_B+(1+\beta)R_E)}$$

If $(R_B \ll (1 + \beta)R_E)$ then

$$A_V = 1.0$$

- (b) The Input Impedance of the common collector (emitter follower) circuit

The Input Impedance is the ratio

$$Z_{in} = \frac{\Delta V_{in}}{\Delta I_{Base}}$$

Use ΔI_{Base} from above

$$Z_{in} = (R_B + r_b + (1 + \beta)(R_E + r_e))$$

Again, if we neglect r_b and r_e and assume that $\beta \gg \frac{R_B}{R_E}$ then

$$Z_{in} = \beta R_E$$

- (c) The Output Impedance of the common collector (emitter follower) circuit

To calculate this, we assume no change to V_{in} (ie $\Delta V_{in} = 0$) but draw a small current ΔI_{out} from the output (emitter pin) and calculate or measure the resulting ΔV_{out} .

We concern ourselves only with the current and voltage increments so can ignore the +0.7 volt battery. Again, define the voltage on the point below the current generator at the join of the 3 lines as ΔV_{join}

As with the Common Emitter before, we can obtain 2 equations.

$$i. \Delta V_{join} = -\Delta I_{base}(R_B + r_b)$$

$$ii. V_{join} = (\beta + 1)\Delta I_{base}r_e + ((1 + \beta)\Delta I_{base} - \Delta I_{out})R_E$$

$$-\Delta I_{base}(R_B + r_b) = (\beta + 1)\Delta I_{base}r_e + ((1 + \beta)\Delta I_{base} - \Delta I_{out})R_E$$

Grouping the I_{base} terms on the right

$$\Delta I_{out}R_E = \Delta I_{base}[R_B + r_b + (1 + \beta)(r_e + R_E)]$$

$$\Delta I_{base} = \frac{\Delta I_{out}R_E}{[R_B+r_b+(1+\beta)(r_e+R_E)]}$$

The change in the output voltage ΔV_{out} is due to the two changes in current through R_E

$$\Delta V_{out} = ((\text{increase in emitter current}) - (\text{current drawn from output}))R_E$$

$$\Delta V_{out} = ((1 + \beta)\Delta I_{base} - \Delta I_{out})R_E$$

$$\Delta V_{out} = ((1 + \beta)\frac{\Delta I_{out}R_E}{[R_B+r_b+(1+\beta)(r_e+R_E)]} - \Delta I_{out})R_E$$

The Output impedance is

$$Z_{out} = -\frac{\Delta V_{out}}{\Delta I_{out}} = -(1 + \beta)\frac{R_E^2}{[R_B+r_b+(1+\beta)(r_e+R_E)]} + R_E$$

$$Z_{out} = -(1 + \beta)\frac{R_E^2}{[R_B+r_b+(1+\beta)(r_e+R_E)]} + R_E$$

$$Z_{out} = -\frac{(1+\beta)R_E^2}{[R_B+r_b+(1+\beta)(r_e+R_E)]} + R_E$$

$$Z_{out} = \frac{-(1+\beta)R_E^2 + [R_B+r_b+(1+\beta)(r_e+R_E)]R_E}{[R_B+r_b+(1+\beta)(r_e+R_E)]}$$

$$Z_{out} = \frac{+[R_B+r_b+(1+\beta)(r_e)]R_E}{[R_B+r_b+(1+\beta)(r_e+R_E)]}$$

If r_b and r_e are very small

$$Z_{out} = \frac{R_B R_E}{[R_B+(1+\beta)R_E]}$$

If β is large

$$Z_{out} = \frac{R_B}{1+\beta}$$

The output impedance has been lowered to a fraction $\frac{1}{1+\beta}$ of the R_B . In this way, an emitter follower (common collector circuit) can be used to lower the effective output impedance of any device which might have had an output impedance of R_E .

The emitter follower (common collector) circuit is often used together with another circuit which might already provide sufficient voltage gain.

- By adding an emitter follower before the another circuit, the input impedance of the combination may be raised by a factor of about β .
- By adding an emitter follower after the another circuit, the output impedance of the combination may be lowered by a factor of about β .

4. Common Base

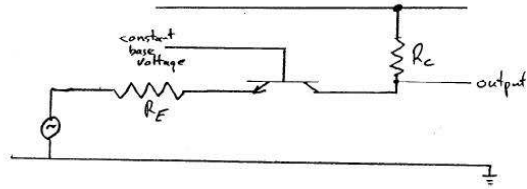

This has 2 resistors as shown R_E and R_C attached to the emitter and collector. The top “rail” is attached to a positive power supply (perhaps +10 Volt). The lower “rail” is the ground.

The Base is attached directly to a constant voltage, say +3.0 volt and so can act as a common reference point for both the input side and the output side.

Define the voltage on the point below the current generator at the join of the 3 lines as ΔV_{join} . Define the voltage on the point X below the current generator as ΔV_X .

The transistor can be replaced for calculation purposes by the transistor model as in the next diagram.

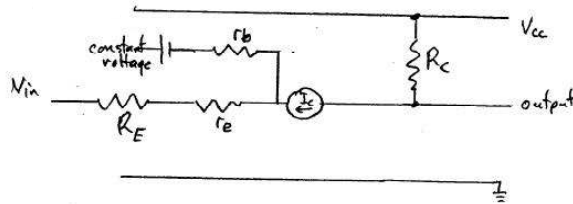

We will later apply a small incremental voltage ΔI_{in} to the point X between the resistor R_E and the emitter.

- (a) First, however, consider the circuit with no inputs signals (ie $\Delta I_{in} = 0$).

The Transistor Model gives us the equivalent circuit for incremental voltages and currents.

If $V_b = +3.0$ volt, then

$$V_{join} = +3.0 \text{ volt} - 0.7 \text{ volt} - r_b I_b \quad (1)$$

The current through the resistor R_E and internal resistance r_e is

$$I_C + I_b = (\beta + 1)I_b$$

The voltage at point “join” is

$$V_{join} = (I_C + I_b)(r_e + R_E)$$

$$V_{join} = (\beta + 1)I_b(r_e + R_E) \quad (2)$$

$$V_C = 10 \text{ volt} - I_C R_C = 10 \text{ volt} - (\beta + 1)I_b R_C \quad (3)$$

Use equations 1 and 2 to eliminate V_{join} .

$$2.7 \text{ volt} - r_b I_b = (\beta + 1)I_b(r_e + R_E)$$

$$I_b = \frac{2.7 \text{ volt}}{r_b + (\beta + 1)(r_e + R_E)}$$

Substitute this I_b into equation 3.

$$V_C = 10 \text{ volt} - (\beta + 1) \frac{2.7 \text{ volt}}{r_b + (\beta + 1)(r_e + R_E)} R_C \quad (4)$$

- (b) Now calculate these again but with the addition of an input current I_{in} due to the signal introduced via a capacitor. Consider the circuit with an injected input current signal, $\Delta I_{in} = 0$.

The Transistor Model gives us the equivalent circuit for incremental voltages and currents. Calculate the new values for V_{join} , I_C , I_b , and V_C .

If $V_b = +3.0 \text{ volt}$, then

$$V_{join} = +3.0 \text{ volt} - 0.7 \text{ volt} - r_b I_b \quad (5)$$

The current through internal resistance r_e is $I_C + I_b = (\beta + 1)I_b$. However the current through the resistor R_E will differ due to the input signal.

The voltage at point “join” is

$$V_{join} = (I_C + I_b)r_e + (I_C + I_b + \Delta I_{in})R_E$$

$$V_{join} = ((\beta + 1)I_b)r_e + ((\beta + 1)I_b + \Delta I_{in})R_E \quad (6)$$

$$V_C = 10 \text{ volt} - I_C R_C = 10 \text{ volt} - (\beta + 1)I_b R_C \quad (7)$$

Use equations 5 and 6 to eliminate V_{join} .

$$2.7 \text{ volt} - r_b I_b = ((\beta + 1)I_b)r_e + ((\beta + 1)I_b + \Delta I_{in})R_E$$

This can be simplified

$$2.7 \text{ volt} - \Delta I_{in}R_E = (r_b + (\beta + 1)(r_e + R_E))I_b$$

$$I_b = \frac{2.7 \text{ volt} - \Delta I_{in}R_E}{r_b + (\beta + 1)(r_e + R_E)}$$

Substitute this I_b into equation 7.

$$V_C = 10 \text{ volt} - (\beta + 1) \frac{2.7 \text{ volt} - \Delta I_{in}R_E}{r_b + (\beta + 1)(r_e + R_E)} R_C \quad (8)$$

Compare this equation 8 with the previous equation 4. The injected input current ΔI_{in} has changed the output voltage by

$$\Delta V_{out} = \text{New } V_C - \text{Old } V_C = (\beta + 1) \frac{\Delta I_{in}R_E}{r_b + (\beta + 1)(r_e + R_E)} R_C \quad (9)$$

If r_e and r_b are small,

$$\Delta V_{out} \approx (\beta + 1) \frac{\Delta I_{in}R_E}{(\beta + 1)(R_E)} R_C \quad (10)$$

$$\Delta V_{out} \approx \Delta I_{in}R_C \quad (11)$$

Note

- a positive current injection through the input coupling capacitor causes a positive voltage excursion on the collector – NO INVERSION.
- The output ΔV_{out} is the same as if the injected current ΔI_{in} were subtracted by the transistor from its current through the resistor R_C to keep the current through R_E constant. The current through the resistor R_C changes by $-\Delta I_{in}$ causing an output voltage excursion $\Delta V_{out} \approx +\Delta I_{in}R_C$ which has the same polarity as the input current signal.

From this, as before we can calculate 3 important parameters for this circuit.

- (a) The Voltage Gain of the common base circuit

- (b) The Input Impedance of the common base circuit
- (c) The Output Impedance of the common base circuit

6 A Useful form of the Common Emitter Amplifier

The common emitter amplifier needs the input voltage to be a few volts above ground so that, some current flows through the equivalent junction battery and some current flows through the collector to the emitter. We say we need to “bias” the base input to ensure the transistor stays in this working region where β is fairly constant. This is particularly important in the amplification of AC since the coupling capacitor blocks any DC input.

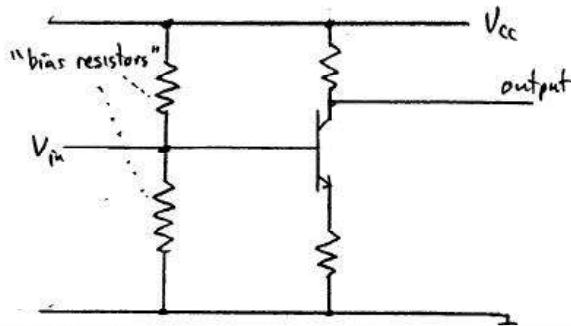

A simple way of “biasing” the AC common emitter is to add two resistances with resistances higher than the emitter resistor so that the “drain current” draining down through both “bias resistors” satisfies two requirements.

1. The drain current is much greater than the current into the transistor base so that the DC voltage at the base is determined by the bias resistors and the supply voltage rather than the transistor which is unpredictable and
2. the two resistors, when seen from the input, do not present a low impedance. Since the amplifier may have been preceded by a preamplifier, this requirement is usually that the input impedance of the two bias resistors should be large compared with the collector resistance of the preamplifier.

Often, these two conditions imply that the bias resistors must be kept between two limits which are a factor of about β apart. For example, if β is about $\beta = 65$, then choose bias resistors giving the following.

1. A total bias drain current from supply to ground of about 8 times the transistor’s base current and $\frac{8}{65}$ times the emitter current.

- The parallel impedance of the two bias resistors about 8 times the output impedance of the previous amplifier.

7 A More Useful Form of the Common Emitter Amplifier

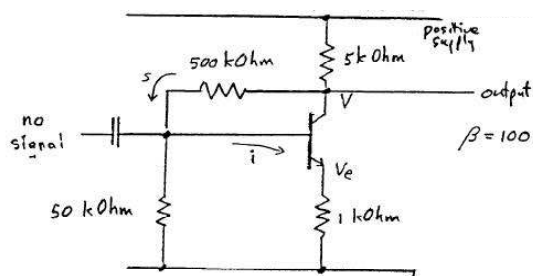

The circuit is similar to the previous common emitter amplifier but the biasing structure has been changed to include some negative feedback from output signal on the collector. As a result, this circuit gives an amplification which is more predictable in spite of variations in the β of the transistor.